

NAVSEA  
STANDARD ITEM  
NUMERICAL INDEX

<u>ITEM NO.</u>	<u>TITLE</u>	<u>UTILIZATION CATEGORY</u>	<u>DATE</u>
009-01	General Criteria; accomplish	I	25 OCT 2022
009-02	Environmental Compliance Report for Material Usage; accomplish	I	25 OCT 2022
009-03	Toxic and Hazardous Substance; control	I	25 OCT 2022
009-04	Quality Management System; provide	I	25 OCT 2022
009-05	Temporary Access; accomplish	I	25 OCT 2022
009-06	Maintaining Protection and Cleanliness from Non-Radioactive Operations; accomplish	I	25 OCT 2022
009-07	Confined Space Entry, and Certification; accomplish	I	25 OCT 2022
<b>009-08</b>	<b><i>Shipboard Fire Protection and Fire Prevention; accomplish</i></b>	<b><i>I</i></b>	<b><i>27 FEB 2023</i></b>
009-09	Process Control Procedure (PCP); provide and accomplish	II	25 OCT 2022
009-10	Asbestos-Containing Material (ACM); control	I	25 OCT 2022
009-11	Insulation and Lagging; accomplish	II	25 OCT 2022
009-12	Weld, Fabricate, and Inspect; accomplish	II	25 OCT 2022
009-13	Meter, Gage, Switch, and Thermometer; repair	II	25 OCT 2022
009-15	Rotating Machinery; balance	II	25 OCT 2022
009-16	Electronic Equipment; repair	II	25 OCT 2022
009-17	Rotating Electrical Equipment; repair	II	25 OCT 2022
009-18	Mine Warfare Ships Magnetic Material; control	I	25 OCT 2022
009-19	Provisioning Technical Documentation (PTD); provide	I	25 OCT 2022

<u>ITEM NO.</u>	<u>TITLE</u>	<u>UTILIZATION CATEGORY</u>	<u>DATE</u>
009-20	Government Property; control	I	25 OCT 2022
009-21	Alteration Verification, Logistics and Technical Data; provide	I	25 OCT 2022
009-23	Interference; remove and install	I	25 OCT 2022
009-24	Authorization, Control, Isolation, Blanking, Tagging and Cleanliness; accomplish	I	25 OCT 2022
009-25	Structural Boundary Test; accomplish	II	25 OCT 2022
009-26	Deck Covering; accomplish	II	25 OCT 2022
009-27	Material Identification and Control (MIC) for Level I System; accomplish	II	25 OCT 2022
009-30	Boiler Sample Tube; inspect	II	25 OCT 2022
009-31	Boiler Waterjet Cleaning; accomplish	II	25 OCT 2022
009-32	Cleaning and Painting Requirements; accomplish	II	25 OCT 2022
009-33	Rotating Electrical Equipment; rewind	II	25 OCT 2022
009-34	Fire Protection of Unmanned Vessel at Contractor Facility; accomplish	I	25 OCT 2022
009-36	Controller; repair	II	25 OCT 2022
009-37	General Procedure for Woodwork; accomplish	II	25 OCT 2022
009-38	Boiler, Catapult Accumulator, and Reboiler Dry Lay-up; accomplish	II	25 OCT 2022
009-39	Technical Manual Contract Requirement (TMCR) for a New Technical Manual for Commercial Equipment/Component; accomplish	I	25 OCT 2022
009-40	Contractor Crane, Multi-Purpose Machine and Material Handling Equipment at a Naval Facility; provide	I	25 OCT 2022
009-45	Tapered Plug Valve; repair	II	25 OCT 2022
009-46	Butterfly Valve, Synthetic and Metal Seated; repair	II	25 OCT 2022

<u>ITEM NO.</u>	<u>TITLE</u>	<u>UTILIZATION CATEGORY</u>	<u>DATE</u>
009-47	Gate Valve; repair	II	25 OCT 2022
009-48	Pressure Seal Bonnet Valve Shop Repair; accomplish	II	25 OCT 2022
009-49	Pressure Seal Bonnet Valve In-line Repair; accomplish	II	25 OCT 2022
009-50	Horizontal Swing Check Valve; repair	II	25 OCT 2022
009-52	Relief Valve; repair	II	25 OCT 2022
009-53	Bolted Bonnet, Globe, Globe Angle, and Globe Stop Check Valve Shop Repair; accomplish	II	25 OCT 2022
009-54	Bolted Bonnet, Globe, Globe Angle, and Globe Stop Check Valve In-line Repair; accomplish	II	25 OCT 2022
009-55	Regulating/Reducing Valve; repair	II	25 OCT 2022
009-56	Main Propulsion Boiler Wet Lay-up; accomplish	II	25 OCT 2022
009-57	Reduction Gear Security; accomplish	II	25 OCT 2022
009-58	Pump and Driver Shaft Alignment; accomplish	II	25 OCT 2022
009-60	Schedule and Associated Reports for CNO Availabilities; provide and manage	I	25 OCT 2022
009-61	Shipboard Use of Fluorocarbons; control	I	25 OCT 2022
009-62	Boiler Handhole, Manhole Seat and Plate; inspect	II	25 OCT 2022
009-63	Lubricating Oil and Hydraulic Fluid; analyze	II	25 OCT 2022
009-64	Cancelled		25 OCT 2022
009-65	Polychlorinated Biphenyls (PCBs); control	II	25 OCT 2022
009-67	Integrated Total Ship Testing; manage	I	25 OCT 2022
009-68	Cancelled		25 OCT 2022
009-69	Heavy Weather/Mooring Plan; provide	I	25 OCT 2022

<u>ITEM NO.</u>	<u>TITLE</u>	<u>UTILIZATION CATEGORY</u>	<u>DATE</u>
009-70	Confined Space Entry, Certification, Fire Protection, Fire Prevention, and Housekeeping for Unmanned Vessel; accomplish	I	25 OCT 2022
009-71	Piping System; test	II	25 OCT 2022
009-72	Physical Security at a Private Contractor Facility; accomplish	I	25 OCT 2022
009-73	Shipboard Electrical/Electronic Cable Procedure; accomplish	I	25 OCT 2022
009-74	Occupational, Safety and Health Plan; accomplish	I	25 OCT 2022
009-75	Circuit Breaker; repair	II	25 OCT 2022
009-76	Waveguide and Rigid Coaxial Lay-Up; accomplish	II	25 OCT 2022
009-77	Cofferdam Installation; accomplish	II	25 OCT 2022
009-78	Passive Countermeasures System (PCMS) Material; repair	II	25 OCT 2022
009-79	Government Owned Material (GOM) Status for Multi-Ship Multi-Option availabilities; report	II	25 OCT 2022
009-80	Ship Facilities; maintain	I	25 OCT 2022
009-81	Compartment Closeout; accomplish	I	25 OCT 2022
009-82	Installation of Equal Component Vice Specified Component; report	I	25 OCT 2022
009-83	Wire Rope Assembly; fabricate	II	25 OCT 2022
009-84	Threaded Fastener Requirements; accomplish	I	25 OCT 2022
009-85	Government Sponsored Planning Yard/Configuration Data Manager (CDM) On-Site Representative Facility; provide	II	25 OCT 2022
009-86	Recovery and Turn-In of Ozone Depleting Substance (ODS); accomplish	II	25 OCT 2022
009-87	Chemical Disinfection Procedure; accomplish	II	25 OCT 2022

<u>ITEM NO.</u>	<u>TITLE</u>	<u>UTILIZATION CATEGORY</u>	<u>DATE</u>
009-88	Collection, Holding and Transfer (CHT) and Motor Gasoline(MOGAS) Tanks, Spaces, and Piping, including Sewage or MOGAS-Contaminated Tanks, Spaces, and Piping; certify	I	25 OCT 2022
009-89	Contractor Furnished Anode(Purchase and Inspection); accomplish		Deleted
009-90	Technical Representative; provide	II	25 OCT 2022
009-91	Propeller In-Place Inspection; accomplish	II	25 OCT 2022
009-92	Resilient Mount; install	II	25 OCT 2022
009-93	Emergency Planning and Community Right-to-Know Act (EPCRA) and Pollution Prevention Act (PPA) Information; provide	I	25 OCT 2022
009-95	Mechanically Attached Fitting (MAFs); install	II	25 OCT 2022
009-96	Ball Valve; repair	II	25 OCT 2022
009-99	Ship Departure Report; provide	I	25 OCT 2022
009-100	Ship's Stability; maintain	I	25 OCT 2022
009-101	Ship Transit and Berthing; accomplish	I	25 OCT 2022
009-103	Weight and Moment Change Data; provide	II	25 OCT 2022
009-104	Vibration Testing and Analysis; accomplish	II	25 OCT 2022
009-105	Thermal Sprayed Coating for Machinery Component Repair; accomplish	II	25 OCT 2022
009-106	Work Authorization Form Coordinator (WAFCOR); provide	I	25 OCT 2022
009-107	Piping System Cleanliness Restoration and Flushing (Non-Nuclear); accomplish	II	25 OCT 2022
009-109	Non-SUBSAFE Work on SUBSAFE-Certified Vessel; accomplish	I	25 OCT 2022
009-110	Non-Nuclear Work on a Nuclear Vessel; accomplish	I	25 OCT 2022

<u>ITEM NO.</u>	<u>TITLE</u>	<u>UTILIZATION CATEGORY</u>	<u>DATE</u>
009-111	Schedule and Associated Reports for non-CNO Availabilities; provide and manage	I	25 OCT 2022
009-112	Prevention of Radiographic-Inspection Ionizing-Radiation Hazard; accomplish	II	25 OCT 2022
009-113	Rotating Electrical Equipment with a Sealed Insulation System (SIS); rewind	II	25 OCT 2022
009-114	Mold Remediation; accomplish	II	25 OCT 2022
009-115	Bearing Rebabbiting; accomplish	II	25 OCT 2022
009-116	Waste Heat Boiler Sodium Nitrite Wet Lay-up; accomplish	II	25 OCT 2022
009-117	Combat Systems Light-Off Support; provide	I	25 OCT 2022
009-118	CG Deck Loading; accomplish	I	25 OCT 2022
009-120	Fact Finding and Critique of Unplanned Event; manage	I	25 OCT 2022
009-121	Ship Assessment/Inspection; accomplish	II	25 OCT 2022
009-122	Temporary Padeye; install and remove	I	25 OCT 2022
009-123	Fiber Optic Component; remove, relocate, repair, and install	II	25 OCT 2022
009-124	Thermal Spray NonSkid Application; accomplish	II	25 OCT 2022
009-125	Boats Less Than 65 Feet Long; accomplish	I	25 OCT 2022

NAVSEA  
STANDARD ITEM

FY-24

ITEM NO: 009-01  
DATE: 25 OCT 2022  
CATEGORY: I

1. SCOPE:

1.1 Title: General Criteria; accomplish

2. REFERENCES:

2.1 Standard Items

2.2 DOD 5220.22-M, National Industrial Security Program Operating Manual

2.3 40 CFR Part 61, National Emission Standards for Hazardous Air Pollutants

3. REQUIREMENTS:

3.1 Report delays to the SUPERVISOR.

3.1.1 In the event difficulty is encountered or anticipated in complying with the contract schedule dates, notify the SUPERVISOR immediately by verbal means, followed on the next work day by an original and 2 copies of a letter stating pertinent details. Receipt of this notification by the SUPERVISOR is not to be construed as a waiver of the requirements, delivery schedule by the Government, or waiver of rights or remedies provided by law or under this Job Order or any other requirements in the Job Order relating to jeopardy of contract schedule dates.

3.2 Reports:

3.2.1 When a Work Item does not require a report, and one is determined to be necessary in order to produce a reliable or complete repair, submit one legible copy, in approved transferrable media, of a report with supporting data as early as possible in the contract period.

3.2.2 For reports required by 2.1 or the Work Item, that could result in a change in work to be accomplished or additional material to be procured, complete the preliminary work and submit one legible copy, in approved transferrable media, of the report in a time frame to allow the SUPERVISOR to initiate early action, but no later than the first 20 percent of the availability. Any exceptions for submission of a report after the first 20 percent of the availability must be approved by the SUPERVISOR.

3.2.3 Reports are costly to generate and process. Identify suspected duplicative reporting requirements and cases where required reports could be combined in order to eliminate a report to the SUPERVISOR via e-mail. Receipt of this notification by the SUPERVISOR is not to be construed as a waiver of the reporting requirements unless the SUPERVISOR's response eliminates the required report.

3.2.4 Submit one legible copy, in approved transferrable media, of the following unless waived by the SUPERVISOR one day prior to the weekly progress meeting:

3.2.4.1 A report listing Government Furnished Material not received, showing the associated Work Item number and title, material description, expected delivery date, required delivery date, effect on production dates, and action proposed to resolve problems resulting from late delivery. Material with expected delivery dates before the required delivery date need not be listed in this report.

3.2.4.2 A report listing late or deficient Government Furnished Information, showing the associated Work Item number, deficiency description, and proposed corrective action.

3.2.4.3 A report of overdue contractor condition reports by Work Item number and expected submission date. The report must also include those deficiency and condition reports for which Government response is outstanding.

3.2.5 Dry dock, or dry berth for Navy boats and craft, related inspection reports must be submitted no later than the first 20 percent of the scheduled docking or dry berth period. Any exceptions for submission of a report after the first 20 percent of the scheduled docking or dry berth period must be approved by the SUPERVISOR. Dry dock or dry berth related reports which contain readings (final, thickness, etc.), clearances, alignments, test results, or other such data for work that has to be completed prior to pre-flood, undocking, or floating for Navy boats and craft must be submitted to the SUPERVISOR within one day after recording the data but no later than 4 days prior to pre-flood, undocking, or floating for Navy boats and craft whichever occurs first.

3.2.6 Reports must contain the following information:

3.2.6.1 Name and hull number of ship or craft, the Job Order, Work Item, and paragraph numbers including Standard Item and paragraph number if applicable.

3.2.6.2 A description of the conditions found with supporting data. Include annotated sketches, graphs, and photographs when necessary to make a report clearly understandable to the SUPERVISOR. Identify actual readings/dimensions taken.

3.2.6.3 Recommendations including; description of work, list of material required, and applicable references to the paragraph number.

3.2.6.4 Reports with recommendations to issue growth or new work RCCs will include if projected cost is more/less than SDVG threshold, and impact on key events or milestones.

3.2.6.5 For those reports not submitted in NMD, submit the following additional information: data required by, signature, printed name, and title of the contractor's representative, and submission date.

3.2.7 Prepare and submit one legible copy, in approved transferrable media, of a listing of all reports and Process Control Procedures (PCP) required by the CNO/CMAV Job Order to the SUPERVISOR no later than 15 days prior to the start of the CNO/CMAV availability. The listing must be sequential by Work Item number, and include each applicable paragraph number, PCP/report due date, completion date, submission date, and a provision for adding report serial numbers from NMD. When the equivalent information is provided in the Test and Inspection Plan (TIP) the report is not required.



3.2.7.1 The report must be revised and provided weekly throughout the availability to include additions, deletions, modifications, progress, completions, and serial numbers from NMD (e.g., Contractor Furnished Reports (CFR)) after numbers are assigned to the reports.

3.2.8 Where one legible copy of a report in hard copy or approved transferrable media is required, or where sketches, graphs, or photographs are required, the electronic methods and file format must be as agreed to by the SUPERVISOR.

3.2.8.1 Use the CFR module in NMD, for contracts managed in NMD.

3.2.9 When a report is required to be submitted but no time requirement is specified in the Standard Item or Work Item, it must be submitted no later than 4 days after completion of the event.

3.3 Accomplish tests and checkouts.

3.3.1 Complete work that requires tests in time to allow correction of deficiencies prior to dock trials, sea trials, or other applicable milestones established in the Job Order.

3.3.2 Do not operate new, existing, or repaired equipment on the ship. Ship's Force will accomplish such operation when required for test, maintenance, and checkout purposes. Such requirements will be coordinated by the SUPERVISOR.

3.3.2.1 Exception will be on unmanned vessels when Ship's Force is not present.

3.4 Provide labor, material, equipment, and services (such as air, power, water, etc.) which are required to complete the Work Item, including that which is indicated on drawings or test specifications as being provided by sources other than the contractor, unless specifically listed as Government Furnished Material (GFM) in paragraph 5 of the Work Items.

3.4.1 When a performance specification (such as MIL-PRF) is specified, the products approved to that specification are those listed on the Government Qualified Products Database (QPD) for that performance specification. If a Type, Class, Grade or other subcategory is listed, the products approved for use are limited to those that meet that subcategory on the performance specification's QPD.

3.4.2 Manufacture parts that are not available from the vendor/manufacturer, utilizing NAVSEA approved drawings, technical manuals, templates, or sketches.

3.4.2.1 Verify latest revisions are correct via the SUPERVISOR prior to start of manufacture.

3.4.3 Submit one legible copy, in approved transferrable media, of a status report, listing Contractor Furnished Material (CFM) required to accomplish the work in Work Items that is not already on hand, to the SUPERVISOR not later than 30 days after the Job Order award, or 2 days after availability start date, whichever occurs first. Update the report and submit revisions to the SUPERVISOR every 14 days up to availability start date, within 10 days after availability start date, then monthly thereafter to End of Availability (EOA). The reports are to contain the following:

3.4.3.1 Contract number

3.4.3.2 Contractor's purchase order number

- 3.4.3.3 Description of material
- 3.4.3.4 Quantity ordered
- 3.4.3.5 Date ordered
- 3.4.3.6 Date required to meet production schedule
- 3.4.3.7 Proposed receipt date
- 3.4.3.8 A summary listing any problem areas
- 3.4.3.19 Date submitted to the SUPERVISOR
- 3.4.3.10 Alteration number
- 3.4.3.11 Drawing and piece number
- 3.4.3.12 Manufacturer
- 3.4.3.13 Manufacturer's part number
- 3.4.3.14 Date received
- 3.4.3.15 Work Item number
- 3.4.3.16 Late CFM that affects production dates

3.4.4 Purchase Orders

3.4.4.1 Maintain a file of purchase orders for CFM for review by the SUPERVISOR upon request.

3.4.4.2 Submit one legible copy, in approved transferrable media, of selected purchase orders to the SUPERVISOR upon request.

3.5 When a Work Item references Class and Hull specific configuration and Ship Alteration information, planning activity must validate that reference information (Ship Alteration drawings, LARS, "as built drawings", Test Procedures, etc.) used is correct via the assigned Class Planning Yard.

3.6 Procure Military Specifications and Standards and Commercial Specifications and Standards.

3.6.1 Procure unclassified, Military Specifications and Standards, and Commercial Specifications and Standards referenced in the Work Items.

3.6.2 Classified Military Specifications are available at the office of the SUPERVISOR.

3.6.3 Work Items will normally reference the basic Government Specifications, or Standards. Note the revision designation (letter and/or number) of each reference. If the reference is the first issuance, do not use Rev Ø, Rev – or Rev to indicate this.

3.7 Work Items may reference specific revision levels of equipment technical manuals or drawings. When these references are listed in a Work Item without suffix letters or numbers which identify revisions, change notices, or amendments, unless otherwise specified, the effective issue of technical manuals, including revisions, change notices, or amendments, must be the most recent issue at the date of solicitation for the Job Order.

3.8 Submit requests for deviations to the SUPERVISOR.

3.8.1 A deviation is defined as any action which is not in conformance with the Work Item requirements, including references thereto, no matter how minor.

3.8.2 Deviations from Work Items and references thereto will not be considered by the SUPERVISOR without a written request from the contractor.

3.8.3 Submit one legible copy, in approved transferrable media, of requests for deviations to the SUPERVISOR within one day of identifying the deviation.

3.8.4 For technical deviations from the references of any Work Item, include the following minimum information:

- 3.8.4.1 Ship name
- 3.8.4.2 Hull number
- 3.8.4.3 Contractor/Subcontractor
- 3.8.4.4 Name of deviation requestor
- 3.8.4.5 Identification as an existing condition or result of repair
- 3.8.4.6 Duration of repair with and without the deviation
- 3.8.4.7 System, component as indicated in the applicable selected record drawing
- 3.8.4.8 Location by compartment, frame and deck
- 3.8.4.9 Description of the deviation and degree of non-compliance
- 3.8.4.10 Document deviated from
- 3.8.4.11 Technical justification for the deviation
- 3.8.4.12 Alteration number if applicable
- 3.8.4.13 Proposed resolution meeting the requirements of 3.2.6 through 3.2.6.5 reports.
- 3.8.4.14 Date SUPERVISOR response is needed by

3.8.5 The Government does not have an obligation to approve any deviation; it may elect to do so if benefit to the Government can be shown. Accomplish deviation only when authorized in writing by the SUPERVISOR.

3.9 Submit documents (including procedures, required reports, plans, forms) requiring SUPERVISOR review, approval, acceptance or direction via an NMD CFR unless otherwise directed by the SUPERVISOR.

3.10 Comply with security requirements.

3.10.1 In the event that the work required by the Job Order requires access to spaces or equipment that are classified, or use of technical manuals, references, or drawings that are classified, the specific security clearance requirements will be identified in the individual Work Item in addition to the requirements provided in the Invitation for Bid/Request for Proposal (IFB/RFP) by the Contract Security Classification Specification (DD Form 254).

3.10.2 Verify that personnel, including subcontractor's personnel, are cleared for the required level of security classification for handling, repair, installation, and testing of classified equipment and for access to areas of the ship which require a specific security clearance.

3.10.2.1 After selection of a subcontractor, prepare in triplicate a DD Form 254 for the subcontract and request the official designated in Paragraph 14.b of the DD Form 254 for the prime contract to approve and sign the DD Form 254 for the subcontract and to make the required distribution. In preparing the DD Form 254 for subcontracts, extract pertinent data from the DD Form 254 pertaining to the prime contract.

3.10.2.2 Prior to starting work on a Work Item that requires a security clearance, submit a list in triplicate of the names, badge numbers or other identification numbers, and security clearances of contractor and subcontractor personnel who will require access to classified information or areas in order to accomplish the work.

3.10.3 Verify that classified equipment removed from ship and classified documents, such as drawings, technical manuals, and test specifications, are marked or tagged and safeguarded at all times in accordance with 2.2.

3.11 Comply with applicable federal, state, and local laws, codes, ordinances, and regulations in their entirety. Any reference to a specific portion of a federal, state, or local law, code, ordinance, or regulation in this or any other item must not be construed to mean that relief is provided from any other sections of the law, code, ordinance, or regulation.

3.11.1 Provide appropriate notification to regional United States Environmental Protection Agency (EPA) in accordance with the requirements of 2.3. Also, comply with notification requirements of state and local air pollution control laws.

3.11.2 Submit one legible copy, in approved transferrable media, of notification required in 3.11.1 that has been provided to any regulatory authority for work on board the vessel to the SUPERVISOR within 2 days of providing such notice to the regulatory authority.

3.12 Maintain a current copy at the job site of the Safety Data Sheet(SDS) for each hazardous material that will be utilized aboard the ship and/or in a Navy facility during the performance of this Job Order. Submit one legible copy, in hard copy or approved transferrable media, to the SUPERVISOR upon request.

3.12.1 Each SDS requires a one-time submittal/acceptance unless the SDS changes or this NAVSEA Standard Item and/or references change.

3.13 Comply with applicable federal, state, local, and foreign contractor host country requirements when using Nuclear Regulatory Commission (NRC) licensed radioactive material, Agreement State licensed radioactive material, and/or machine sources of ionizing radiation on Government property.

3.13.1 Do not commence operations using radioactive material or machine sources of ionizing radiation on Government property until authorized in writing by the SUPERVISOR.

3.13.2 Contract personnel must not be used as operators under a Navy Radioactive Material Permit (NRMP) issued to a naval facility. Navy personnel must not be used as operators under a Nuclear Regulatory Commission (NRC) or Agreement State License issued to a contractor.

3.13.3 Submit one legible copy, in approved transferrable media, of a consolidated inventory of all ionizing radiation producing machines or material that will be utilized aboard the ship and/or naval facility during the performance of this Job Order to the SUPERVISOR, 5 days prior to the start of work.

3.13.4 Submit one legible copy, in approved transferrable media, of the applicable NRC or Agreement State License including procedures regarding system process and operation for use of licensed radioactive material, to the SUPERVISOR 5 days prior to the start of work. Agreement State licensees must provide evidence of NRC Form 241 (Report of Proposed Activities in a Non-Agreement State) with the copy of the license for Agreement State licensees.

3.13.5 Submit one legible copy, in approved transferrable media, of the applicable State license, authorization, or registration for machines that produce ionizing radiation, to the SUPERVISOR 5 days prior to the start of work.

3.13.6 Submit one legible copy, in approved transferrable media, of a formal Radiological Safety Plan which must include operating and emergency procedures pertinent to the items listed in 3.13.3, and actions to control jobsite-boundary radiation exposures below those allowed for members of the general public under NRC and OSHA standards, to the SUPERVISOR 5 days prior to the start of work.

3.13.7 Provide the SUPERVISOR with remedies to any radiation safety shortcomings identified by the SUPERVISOR, to be rectified prior to commencing operations.

3.14 Correct errors in record keeping by drawing a single line through the error, recording the correct entry, initialing, dating, and printing the name of the person making the correction.

3.14.1 Corrections to records must be made by the individual that made the original entry and signed for the accuracy and validity of the record, or by cognizant trade manager or project superintendent.

3.14.1.1 Submit corrected report to SUPERVISOR.

3.15 Record and Certification Signature Block or signature must be legible and in ink. Erasures, write-overs, white-outs, ditto marks, continuation arrows, signature stamps, etc., are not acceptable.

3.15.1 Copying records to "make them neat" is not allowed.

3.15.2 Electronic records must utilize electronic signature controls for certification of individual providing signature.

3.16 Do not commence operations that could compromise watertight integrity during waterborne availabilities until confirmation by the SUPERVISOR that the ship has at least one back-up power source immediately available for providing power of minimum load to support firefighting and dewatering equipment in the event of loss of shore power.

3.17 Protect the ship and its equipment from damage.

3.17.1 Conduct formal shift turnover of each work item for each shift.

3.17.2 Shift turnover must include a walkthrough with oncoming and off going supervisors responsible for the execution of the work. (i.e., Hot Work locations and boundaries, list of trades or subcontractors, critical evolutions (i.e., single valve, dive operations, critical lifts), and government check points.

#### 4. NOTES:

4.1 The term "day" means 24 hours prior to or after the scheduled event. "Business day" is used to indicate Monday through Friday, otherwise "day" means calendar day (Sunday through Saturday).

4.2 Known sources for unclassified military specifications and standards are:

<https://mercury.tdmis.navy.mil>

<https://assist.dla.mil>

<http://quicksearch.dla.mil>

4.3 The term "SUPERVISOR" is defined as the local Government activity responsible for the execution and contract administration of Navy maintenance and modernization work.

4.4 The term "Job Order" is synonymous with the term "Contract" and "Task Order".

4.5 The term "approved transferrable media" is the form, system or program for submitting reports required as agreed to by the SUPERVISOR.

4.6 The term "subcontract" means any contract as defined in the FAR, Subpart 2.1, entered into by a subcontractor to furnish supplies or services for performance of a prime contract or a subcontract. It includes but is not limited to purchase orders, and changes and modifications to purchase orders.

4.7 Navy Boats and Craft are defined by S9086-TX-STM-010/CH 583 Volume 1, Boats and Small Craft.

4.8 Service Craft are defined by S9086-BA-STM-010/CH 034 Service Craft.

4.9 Worksite is defined as within the specific compartment or space where physical productive work is occurring. For work performed on Navy boats and craft or service craft, the "worksite" is defined as on or near the vessel.

NAVSEA  
STANDARD ITEM

FY-24

ITEM NO: 009-02  
DATE: 25 OCT 2019  
CATEGORY: I

1. SCOPE:

1.1 Title: Environmental Compliance Report for Material Usage; accomplish

2. REFERENCES:

2.1 42 USC 7412(b), Clean Air Act, Section 112(b), List of Hazardous Air Pollutants

2.2 40 CFR Part 63, National Emission Standards for Hazardous Air Pollutants for Source Categories, Subpart II

3. REQUIREMENTS:

3.1 Contractor facility availabilities:

3.1.1 Designate a contractor primary and secondary point of contact to receive reports applicable under this item.

3.1.2 Submit one legible copy, in approved transferrable media, of the names of the primary and secondary point of contact to the SUPERVISOR prior to availability start date.

3.2 Naval facility availabilities:

3.2.1 Submit one legible copy, in approved transferrable media, of an Environmental Compliance Report for Material usage at Naval Facility as follows:

3.2.2 Submit applicable permits for portable, registered, or rental emission units to the SUPERVISOR prior to start of work.

3.2.3 Establish a record-keeping program to reflect the manner in which the material records will be maintained and submitted to the SUPERVISOR.

3.2.4 Maintain facility specific records to ensure accurate reporting for all preservation, welding repairs, and fuel consumption for each individual portable internal combustion engine or portable emission unit. Provide the SUPERVISOR sufficient details to track usage of all paints, solvents, adhesives, welding rods, and fuel used for each individual portable internal combustion engine over 50-brake horsepower. Report any other materials used which contain chemicals listed in 2.1.

3.2.5 Maintain current usage records of materials listed in 2.1.

3.2.6 Negative reports are required.

3.2.7 Reports for paint, solvent, adhesive, and nonskid usage records must contain the following items based upon category of the material.

3.2.7.1 Product manufacturer, identification or color

3.2.7.2 Net daily paint usage in gallons, paint application method (airless spray, HVLP, brush, or roller) per paint type, amount of paint disposed as hazardous waste; density of mixed paint; net daily onsite solvent usage in gallons used for equipment cleaning and surface preparation; net amount of adhesives in unit of measure (ounces, quart, gallons or pound)

3.2.7.3 Product Safety Data Sheet (SDS), technical data sheet, VOC certification for paint and nonskid product

3.2.7.4 Government site location, applicable local Air Pollution Control District (APCD) permit number, date, and ship's name

3.2.8 Abrasive blast grit materials used must be submitted monthly and must include:

3.2.8.1 Manufacturer of abrasive blast grit and SDS

3.2.8.2 Abrasive blast grit usage certification if required by the cognizant state or local authorities

3.2.8.3 Amount and hourly usage of the abrasive blast grit

3.2.8.4 Permit associated with the abrasive blasting equipment if required by the cognizant state or local authorities

3.2.9 Welding operation report must be submitted monthly and must include filler metal manufacturer, specific product used in welding application, SDS, usage in pounds, and type of welding application.

3.2.10 Portable internal combustion (IC) engine greater than 50 brake horse power operation report must be submitted monthly and must include:

3.2.10.1 Amount of fuel used in gallons and the hours of operation

3.2.10.2 IC engine permit number and site location if required by the cognizant state or local authorities

3.3 Submit one legible copy, in approved transferrable media, of each report required by 3.2 to the SUPERVISOR no later than 10 days after the end of the month throughout the availability.

3.4 Provide a deviation request for each coating that thinning is required to the SUPERVISOR. Upon approval of deviation use Attachment A for Volatile Organic Compounds (VOC) (for Option 1, 2, and 3 thinning requirement use only), or Attachment B for Volatile Organic Hazardous Air Pollutants (VOHAP) (for Option 4 thinning requirement), on the as-supplied coating by the manufacturer, or similar form.

3.4.1 For coatings to which thinners must not be added, the coating container must have a label stating, "NO THINNING".



3.4.2 For coatings to which thinners are to be added, designate a single thinner to be used and determine the maximum allowable thinning ratio using Equation One of 2.2, apply a label to the coating container stating that "THINNER MAY BE ADDED" and also supply the maximum allowable thinning ratio.

3.4.3 No later than the 10th of each month, or at the end of each job, whichever is earlier; submit one legible copy, in approved transferrable media, of a report listing the following to the SUPERVISOR:

3.4.3.1 Volume and type of each coating used the previous month.

3.4.3.2 Volume and type of thinner used the previous month.

3.4.3.3 Calculations used to determine the maximum allowable thinning ratio for each coating that was thinned the previous month.

3.4.4 All handling, thinning, and transfer of coatings, solvents, and related waste must be done in a manner that minimizes spills.

3.4.4.1 All containers of coatings, solvents, and related waste must be free of cracks, holes, and defects such as damage, dents, or ill-fitting lids or covers that compromise the integrity of the container. The containers must remain closed unless materials are being added or removed from the container.

3.4.4.2 All waste materials including rags, brushes, and rollers must be kept in tightly closed containers that minimize evaporation.

#### 4. NOTES:

4.1 Examples of paint and nonskid manufacturers may be Ameron, International, American Safety Technology, or others as applicable.

4.2 Examples of American Welding Society Classifications for welding rod may be E316-16, E7018-AL 308-16, or others. If there is no American Welding Society (AWS) classification assigned, use the product name and circle the product on the SDS.

4.3 Examples of welding applications may be Shielded Metal Arc Weld (SMAW), Gas Metal Arc Weld (GMAW), Flux Core Arc Weld (FCAW), and others.

ATTACHMENT A  
(For Option 1, 2, & 3 Thinning Requirement Use Only)  
VOC DATA SHEET

PROPERTIES OF THE COATING "AS SUPPLIED" BY THE MANUFACTURER

Coating Manufacturer:

Coating Identification:

Batch Identification:

Supplied To:

Properties of the coating as supplied to the customer:

A. Coating Density:  $(D_c)_2$  \_\_\_ g/L

\_\_\_ ASTM D 1475-90 \_\_\_ Other<sup>1</sup>

B. Total Volatiles:  $(m_v)_s$  \_\_\_ Mass Percent

\_\_\_ ASTM D 2369-93 \_\_\_ Other<sup>1</sup>

C. Water Content:

1.  $(m_v)_s$  \_\_\_ Mass Percent

\_\_\_ ASTM D 3792-91 \_\_\_ ASTM D 4017-90 \_\_\_ Other<sup>1</sup>

2.  $(v_w)_s$  \_\_\_ Volume Percent

\_\_\_ Calculated \_\_\_ Other<sup>1</sup>

D. Organic Volatiles:  $(m_o)_s$  \_\_\_ Mass Percent

E. Nonvolatiles:  $(v_n)_s$  \_\_\_ Volume Percent

\_\_\_ Calculated \_\_\_ Other<sup>1</sup>

F. VOC Content (VOC)<sub>s</sub>:

1. \_\_\_ g/L solids (nonvolatiles)

2. \_\_\_ g/L coating (less water and exempt compounds)

G. Thinner Density:  $D_{th}$  \_\_\_ g/L

\_\_\_ ASTM \_\_\_ Other<sup>1</sup>

Remarks: (use reverse side)

H. Certification:

Signed: \_\_\_\_\_ Date:

<sup>1</sup> Explain the other method used under "Remarks"

ATTACHMENT B

(For Option 4 Thinning Requirement Use Only)  
VOHAP DATA SHEET

PROPERTIES OF THE COATING "AS SUPPLIED" BY THE MANUFACTURER

Coating Manufacturer:

Coating Identification:

Batch Identification:

Supplied To:

Properties of the coating as supplied to the customer:

A. Coating Density:  $(D_c)_2$  \_\_\_\_ g/L

\_\_ ASTM D 1475-90 \_\_ Other<sup>1</sup>

B. Total Volatiles:  $(m_v)_s$  \_\_\_\_ Mass Percent

\_\_ ASTM D 2369-93 \_\_ Other<sup>1</sup>

C. Water Content:

1.  $(m_v)_s$  \_\_\_\_ Mass Percent

\_\_ ASTM D 3792-91 \_\_ ASTM D 4017-90 \_\_ Other<sup>1</sup>

2.  $(v_w)_s$  \_\_\_\_ Volume Percent

\_\_ Calculated \_\_ Other<sup>1</sup>

D. HAP Volatiles:  $(m_{hap})_s$  \_\_\_\_ Mass Percent

E. Nonvolatiles:  $(v_n)_s$  \_\_\_\_ Volume Percent

\_\_ Calculated \_\_ Other<sup>1</sup>

F. VOHAP Content (VOHAP)<sub>s</sub>:

1. \_\_\_\_ g/L solids (nonvolatiles)

2. \_\_\_\_ g/L coating (less water and exempt compounds)

G. Thinner VOHAP Density:  $D_{th(vohap)}$  \_\_\_\_ g/L

\_\_ ASTM \_\_\_\_ \_\_ Other<sup>1</sup>

Remarks: (use reverse side)

H. Certification:

Signed: \_\_\_\_\_ Date:

<sup>1</sup> Explain the other method used under "Remarks"

NAVSEA  
STANDARD ITEM

FY-24

ITEM NO: 009-03  
DATE: 25 OCT 2019  
CATEGORY: I

1. SCOPE:

1.1 Title: Toxic and Hazardous Substance; control

2. REFERENCES:

2.1 29 CFR Part 1915, Occupational Safety and Health Standards for Shipyard Employment

3. REQUIREMENTS:

3.1 Identify materials that may contain toxic or hazardous substances as listed in Subpart Z of 2.1 that are to be used, removed, or disturbed during work operations.

3.1.1 Conduct and document an initial determination of potential personnel exposure to these materials prior to the start of work.

3.1.1.1 Provide a copy of the documentation, signed by a competent person as defined in 29 CFR 1915.4, to the SUPERVISOR upon request.

3.2 Ensure that work operations comply with the requirements of 2.1 for the use of toxic or hazardous substances and removal or disruption of existing toxic or hazardous substances.

3.3 Ensure that processes or procedures for work operations that can expose personnel to toxic or hazardous substances comply with the requirements of 2.1. At a minimum, address the following: exposure monitoring, method of compliance, engineering and work practice controls, respiratory protection, protective clothing, housekeeping, hygiene facilities and practices, medical surveillance, employee information and training, signs, and recordkeeping.

3.3.1 Plan for control or removal of toxic and hazardous substances up to the man-days/material costs provided in Attachment A.

3.3.1.1 If total man-days/material costs used for the control or removal of toxic and hazardous substances are less than the man-days/material costs authorized for use specified in Attachment A, remaining funds will be subject to recoupment. The contractor is not authorized to exceed these limits.

3.3.2 Submit one legible copy of process(es) or procedure(s), and man-days/material costs required for each process or procedure, in approved transferrable media, when requested by the SUPERVISOR.

3.4 Provide a notice to the SUPERVISOR and to the Commanding Officer's designated representative at least 4 hours, but not more than 24 hours prior to commencement of any work operation that requires establishment of a regulated area in accordance with the requirements of 2.1 (i.e. cleaning of spaces that have contained flammable or combustible liquids, lead work, cadmium work, asbestos work, etc.)

3.4.1 Post the notice at the ship's Quarterdeck and at all entrances to spaces where work operations will be performed that require posting of warning signs, signs, or establishment of a regulated area.

3.4.2 The notice must contain the following information:

3.4.2.1 Ship's name and hull number

3.4.2.2 Work Item number

3.4.2.3 Compartment or frame number

3.4.2.4 Identification of hazard

3.4.2.5 Date and time of work process

3.4.2.6 Identification of engineering and work practice controls

3.4.3 Deliver notification of work planned over a weekend or Monday following that weekend to the Commanding Officer's designated representative not later than 0900 on the Friday immediately preceding that weekend.

3.4.4 Deliver notification of work planned on a Federal holiday and on the day following the Federal holiday to the Commanding Officer's designated representative not later than 0900 on the last working day preceding the Federal holiday.

3.5 Provide for isolation and blanking of ship's ventilation systems in work areas to prevent toxic or hazardous substance contamination of ventilation systems or other compartments/spaces.

3.6 Establish regulated areas for monitoring and authorized personnel entry whenever concentrations of the toxic or hazardous substance are in excess of exposure limits as listed in 2.1.

3.7 Monitor the affected areas during work operations to ensure compliance with 2.1. Monitoring must include adjacent spaces to ensure the work area containments and work practices are effective. Results of surveillance must be documented and documentation must be made available to the SUPERVISOR.

4. NOTES:

4.1 The term "hazardous substance" means a substance, which by reason of being explosive, flammable, poisonous, corrosive, oxidizing, irritant, or otherwise harmful is likely to cause injury.

4.2 The debris from ventilation cleaning may contain toxic or hazardous substances.

ATTACHMENT A

MAN-DAYS/MATERIAL COSTS AUTHORIZED FOR CONTROL OR REMOVAL OF  
TOXIC AND HAZARDOUS SUBSTANCE REMOVAL PER SHIP CLASS

Ship Class	Man-Days/Material Costs
Air Craft Carriers (CVN)	100 / \$25,000
Amphibious Assault Ships (LHD, LHA)	100 / \$25,000
Amphibious Command Ships (LCC)	100 / \$25,000
Amphibious Transport Docks (LPD)	100 / \$25,000
Amphibious Dock Landing Ships (LSD)	100 / \$25,000
Guided Missile Cruisers (CG)	50 / \$15,000
Guided Missile Destroyers (DDG)	50 / \$15,000
Submarines (SSGN, SSBN, SSN)	50 / \$15,000
Littoral Combat Ships (LCS)	25 / \$10,000
Mine Counter Measures Ships (MCM)	25 / \$10,000
Coastal Patrol Ships (PC)	25 / \$10,000
Repair and Berthing Barge (YRB, YRBM)	25 / \$10,000

NAVSEA  
STANDARD ITEM

FY-24

ITEM NO: 009-04  
DATE: 25 OCT 2022  
CATEGORY: I

1. SCOPE:

1.1 Title: Quality Management System; provide

2. REFERENCES:

2.1 Standard Items

2.2 ANSI/ISO/ASQ Q9001-2015, Quality Management Systems – Requirements

2.3 ISO/IEC 17025, General Requirements for the Competence of Testing and Calibration Laboratories

2.4 NAVSEA 04-4734, Navy and Marine Corps Calibration Laboratory Audit/Certification Manual

2.5 SSPC QP1 Application, Instructions, and Program Rules

2.6 NAVSEA OD 45845, Metrology Requirements List (METRL)

3. REQUIREMENTS:

3.1 Establish, document, implement, and maintain a Quality Management System (QMS) as a means of ensuring that product conforms to specified requirements.

3.2 A written QMS Manual addressing all elements of 2.2 and supporting documented procedures must be submitted to the SUPERVISOR for review and acceptance. Required documented procedures may be contained in either the Manual or Level II QMS procedures. The contractor must have an accepted QMS, in accordance with this Standard Item, in place to receive an award of a Job Order. Include the following documented procedures if not addressed in the contractor's Quality Manual:

3.2.1 Support: Address all areas of Paragraphs 7.1.5, 7.2 and 7.5 of 2.2.

3.2.1.1 Calibration laboratories must be accredited to either 2.3 by a Commercial Accreditation Activity, or certified by a Navy Certification Activity to 2.4. The calibration laboratory's scope must include the parameters required to execute the calibration at



the appropriate ranges and tolerances.

3.2.1.2 Calibration intervals assigned to Measuring and Test Equipment used by the contractor for acceptance testing must meet those recommended in 2.6 and shall reflect TMDE end of period reliability of greater than 85 percent. TMDE reliability data must be provided upon request.

3.2.1.3 Test uncertainty ratios must be greater than 4:1, or ensure a probability of false acceptance of 2 percent or less, and a probability of false rejections of 15 percent or less.

3.2.2 Operation: Address all areas of Paragraphs 8.2, 8.4, 8.5, 8.6, 8.7 of 2.2

3.2.2.1 Verification of Purchased Product: Identify, in the purchasing documents, verification arrangements at the subcontractor or vendor location/premises. Purchasing documents must contain the following statement when the SUPERVISOR requests government inspection: "Government Inspection is required prior to shipment from your plant. Upon receipt of this order, promptly notify and furnish a copy to the Government representative who normally services your plant so that appropriate planning for government inspection can be accomplished. In the event the government representative or office cannot be located, our purchasing agent must be notified immediately.

3.2.2.2 Unless otherwise specified in a higher tier document, Receipt Inspection of contractor furnished materials must be based on supplier performance history and one or more of the following: certificate of compliance, vendor material test certification data, manufacturer's mill certificate, or testing using sampling techniques.

3.2.3 Performance evaluation: Address all areas of Paragraphs 9.2 and 9.3 of 2.2

3.2.4 Improvement: Address all areas of Paragraph 10.2 of 2.2.

3.2.5 The documented QMS must include a matrix listing the correlation between 2.2, 3.2 and the corresponding paragraph/sub-paragraph(s) of the submitted documented procedures.

3.3 Subsequent to SUPERVISOR acceptance, a contractor's QMS certification is acceptable in any other geographic location in which the contractor maintains the same QMS, providing:

3.3.1 The contractor uses the same QMS Manual.

3.3.2 The contractor uses the same QMS Manager as the final decision authority for QMS policy.

3.3.3 Successful completion of Contractor's QMS Review Checklists (Attachment B, C, and D) in their entirety by the SUPERVISOR.

3.4 The QMS must be subject to audits by the SUPERVISOR throughout the contract. Retain documented information to demonstrate the processes are carried out as planned. Audits must be conducted on active contracts, but may be conducted on completed contracts when there are limited or no active contracts available.

3.5 Submit one legible copy, in hard copy or approved transferrable media, of any revisions, including the planned implementation date, to the accepted QMS identified in 3.2 to the SUPERVISOR within 7 days of contractor approval.

3.6 Submittal of procedures invoked by NAVSEA Standard Items, MIL-STDs, drawings, technical publications, and specifications, although an integral part of the QMS, must be submitted to and approved by the SUPERVISOR independent of the QMS a minimum of 14 days prior to start of required process for planned availabilities, or as otherwise approved by SUPERVISOR.

3.7 The corrective action program must require that a copy of the written responses to contractor generated corrective actions will be provided to the SUPERVISOR when requested.

3.8 Respond in writing to each SUPERVISOR issued Method B/C/D Corrective Action (CA) within 3 business days unless otherwise specified by the SUPERVISOR. Initial response must include immediate corrective action taken and a plan of action for CA completion, including estimated completion dates. Final response must include preventive action for recurrence of identified nonconformance, root cause analysis using Attachment "E" and Objective Quality Evidence (OQE) for corrective action completed. When a corrective action response is unsatisfactory, revised response required within 3 business days unless otherwise specified by the SUPERVISOR.

3.8.1 Inform the SUPERVISOR when corrective actions are complete for each SUPERVISOR issued Method A (CA). Response required within 3 business days unless otherwise specified by the SUPERVISOR. Response must state that the non-conformance has been corrected.

3.8.2 Use NMD, or approved Web interface, to perform all CAR functions for contracts managed in NMD.

3.9 Attend SUPERVISOR conducted fact-finding/investigative meetings when requested by the SUPERVISOR not to exceed 4 hours. (See 4.4)

3.10 Develop a Test and Inspection Plan (TIP) incorporating each Work Item in the job order, LOA Chits or Statements of Work (SOW). The initial TIP must include all inspections and tests required by zero-tier references and first tier references, as well as symbols (I), (V), (Q), test/inspections and (G) government notification identified in the Work Item, and any additional tests and inspections the contractor deems necessary to substantiate product conformance.

3.10.1 Submit the initial copy of the TIP to the SUPERVISOR prior to start of

productive work for non-CNO availabilities and no later than 3 days prior to the availability start date for CNO availabilities.

3.10.1.1 Use NMD, or approved Web interface, to perform all TIP functions for contracts managed in NMD. TIP development in NMD using a Web interface satisfies the requirements of 3.10.1.

3.10.1.2 Submit one legible copy of the initial TIP, in hard copy or approved transferrable media that can be sorted (e.g., Excel spreadsheet) for contracts not managed in NMD.

3.10.1.3 Submit one legible copy, in hard copy or approved transferrable media that can be sorted (e.g., Excel spreadsheet) of an updated TIP when requested by the SUPERVISOR not to exceed one per week for contracts not managed in NMD.

3.10.2 A TIP must:

3.10.2.1 Be revised prior to the start of productive work and updated as work proceeds on each Work Item. Supporting data for tests and inspections requiring government notification (G), including accept/reject criteria, must be available at the location of each test and inspection. Include provisions for documenting the date, time, and identification of the SUPERVISOR's representative notified and government representative attending each (G)-Point on the TIP. The TIP must annotate the relationship to a specific key event unless otherwise agreed upon by the SUPERVISOR. The following key events must be considered at a minimum (as applicable): Undocking, Production Completion Date (PCD), Command, Control, Communications, Computer, Combat Systems, and Intelligence (C5I) Light-Off (C5ILO), Work Complete (WC), Dock Trials (DT), Fast Cruise (FC), Sea Trials (ST), and Availability Completion (AC).

3.10.2.2 Each test and inspection must be identified by its respective Work Item number and Work Item paragraph number, including Standard Item paragraph number, unique identifier (number) that is used in both the TIP and IPS of 009-60, and must include inspection symbols (I), (Q), (V), and the government notification (G) Point symbol where applicable.

3.10.2.3 Provide identification of the item to be inspected by name, number, and location (e.g., number 3 main feed pump, 5-180-0-E).

3.10.2.4 Provide identification of each characteristic of the items to be inspected and provide the criterion for acceptance for each characteristic (e.g., air test; 2 PSIG for 10 minutes; no drop).

3.10.2.5 Each test and inspection must not be removed.

3.10.2.6 Provide unique identification of test equipment used.

3.11 Each Test and Inspection record must:

3.11.1 Include the ship's name and hull number, Job Order and Work Item number, a unique serialization number, applicable PCP number, paragraph number, component identification, accept/reject criteria, date, time, unique identification of test equipment used, signature blocks for the Government and contractor authorized representatives who witnessed or performed the test or inspection. The signature occurs after the checkpoint is determined to be satisfactory or unsatisfactory and any exceptions are documented.

3.11.2 Be maintained at a contractor location accessible to the site of the work required by the Job Order.

3.11.3 Be documented within one day of accomplishment or prior to the subsequent tests or inspections, whichever is less. The records must indicate the results of the test and or inspection accomplished. Test or inspection records will clearly identify each location or component when multiple locations or multiple components are listed on a single record. Records must be incorporated into the TIP within 4 days after completion of each test or inspection.

3.11.3.1 For tests and inspections involving (G)-points, records must be documented upon acceptance or rejection and a hard copy (or electronic copy as authorized by the SUPERVISOR) provided to the SUPERVISOR at the conclusion of each (G)-Point. (See 4.5)

3.11.4 Required reports resulting from tests or inspections must include the appropriate design criterion for each attribute or measurement required by the Work Item.

3.12 The SUPERVISOR will consider the Work Item incomplete if the contractor's documentation and records are not complete.

3.13 Accomplish (I), (V) and (Q) tests/inspections that do not have associated (G)-points, with qualified and/or currently certified personnel where required by the technical documents (e.g., NBPI, NACE, nondestructive testing, electrical cableway inspection, Oxygen Cleanliness Inspector, etc.) as follows:

3.13.1 (I) inspections require verification and documentation by a separate individual, other than the person who has accomplished the work, who is qualified as an inspector.

3.13.2 (V) inspections require verification and documentation by the qualified tradesperson, trade supervisor, or inspector.

3.13.3 (Q) inspections require verification and documentation by a qualified Technical Representative in accordance with 009-90 of 2.1 and associated PCP requirements.

3.13.4 The authority to accomplish, document, accept and reject (I) and (V) inspections may be delegated to qualified subcontractor personnel, without regards to geographical location, subject to SUPERVISOR approval.

3.14 Accomplish (G)-Point (government notification) as follows:

3.14.1 (G) is a symbol inserted in a Work Item to establish a point in the sequence of accomplishment of work at which time the SUPERVISOR must be notified by the prime contractor in all cases to permit observation of a specific test or inspection (I)(V) by the government. When the symbol (G) precedes tests or inspections in a Work Item which are applicable to more than one action, the symbol (G) must identify the action required, e.g., (G) "HYDROSTATIC TEST". When more than one unit is involved, the (G) notification requirement applies to each unit.

3.14.2 Notify the SUPERVISOR's designated representative as directed by the SUPERVISOR via FAX, hard copy, or by electronic method.

3.14.2.1 Notify the SUPERVISOR prior to commencing the specific requirements in a paragraph annotated with the symbol (G), during normal day shift working hours with at least 2 hours, but not more than one-day notice. Following the required notification, the requirements in the | paragraph annotated with the symbol (G) may proceed prior to the scheduled time as approved by the SUPERVISOR. Notify the SUPERVISOR to cancel a scheduled test or inspection no later than 30 minutes prior to the scheduled event or as negotiated with the SUPERVISOR.

3.14.2.2 Notify the SUPERVISOR not later than 4 hours before the end of the last preceding normal work day when tests or inspections following a (G) Point are scheduled after normal day shift working hours, on a weekend, or on a federal holiday. Following the required notification, the requirements in the paragraph annotated with the symbol (G) may proceed prior to the scheduled time as approved by the SUPERVISOR. Notify the SUPERVISOR to cancel a scheduled test or inspection as soon as known, but no later than one hour prior to the scheduled event.

3.14.2.3 Notify the SUPERVISOR at least 48 hours, but not more than 72 hours, prior to commencing (G)-Points at contractor's/subcontractor's plants located in excess of 50 miles by the most direct roadway nearest to the place of performance of the contract. Document the date, time, and identification of the SUPERVISOR's representative notified. Following the required notification, the requirements in the paragraph annotated with the symbol (G) may proceed prior to the scheduled time as approved by the SUPERVISOR. Notify the SUPERVISOR to cancel a scheduled test or inspection as soon as known, but no later than one hour prior to the scheduled event.

3.14.3 Proceed with the test or inspection if the SUPERVISOR is not present, provided the required advance notice has been furnished to the SUPERVISOR and the contractor has completed and documented the preceding tests and inspections.

3.14.4 A partial test or inspection requiring (G) notification may be accomplished in the event that all work cannot be completed and work progress would be delayed in waiting for total completion of work. Comply with the requirements of 3.14.2 when the incomplete work is completed and ready for the remainder of the test or inspection. Note partial inspections on the test or inspection form.

3.14.5 A qualified contractor representative must be present to accomplish, accept or reject and document tests or inspections associated with the symbol (G).

3.14.5.1 The authority to witness or perform, document and accept/reject (I)(G), (Q)(G), and (V)(G) tests and inspections is a prime contractor's responsibility but, subject to SUPERVISOR approval within a 50-mile radius of the contractor's plant nearest to the place of performance of the contract, may be delegated to subcontractors who are MSRA or ABR agreement holders, SSPC QP1 certified, NDT certified, or have a current QMS accepted by the SUPERVISOR.

3.14.5.2 The contractor may delegate responsibility to subcontractors to perform, document and accept/reject (I)(G) and (V)(G) tests and inspections performed at plants located outside a 50-mile radius of the contractor's plant nearest to the place of performance of the contract subject to SUPERVISOR prior approval.

3.14.5.3 Associated (G)-Point notification requirements must not be delegated.

3.15 For work being performed outside a 50-mile radius of the place of contract performance, the prime contractor must submit one legible copy, in hard copy or approved transferrable media, of purchase orders to the SUPERVISOR within 2 days or otherwise as directed by the SUPERVISOR, prior to issue of purchase order and shipment of equipment. For contractors who do not utilize purchase orders as a vehicle for accomplishing work within their company, a report identifying the delineation of the specific Work Item requirements, in lieu of the purchase order must be submitted to the SUPERVISOR.

3.16 Maintain a current list for reference by the SUPERVISOR, designating the contractor's qualified and currently certified inspectors who witness or perform and sign for symbol (I) inspections, indicating the type of tests and inspections for which each inspector is qualified and currently certified. When subcontractors are delegated responsibility, the subcontractor's qualified and currently certified inspectors must be included on this list.

3.17 Certify to the SUPERVISOR that work is completed technically correct with all required OQE. All supporting documentation must be submitted in support of the following applicable Key Events: Undocking (if applicable), PCD, C5ILO, WC, DT, FC, ST, and AC. Applicable Key Event ties must also be annotated for each item in the TIP as required by 3.10.2.1.

3.17.1 Notify the SUPERVISOR of the condition and status of each individual Work Item in the availability within 3 days of Work Item completion or a minimum of 5 days

prior to the scheduled Key Event to which that item is tied, whichever occurs first, by one of the following methods:

3.17.1.1 Completion and submission of one legible copy of Attachment A, in hard copy or approved transferrable media.

3.17.1.2 Completion and submission of one legible copy of Event Readiness List (ERL), in hard copy or approved transferrable media.

3.17.1.3 Completion and submission of centralized signature sheet in record book maintained by the SUPERVISOR.

3.17.2 If work is incomplete or complete with discrepancies, supporting rationale and impact statement with recovery plan must be provided to the SUPERVISOR using one of the methods from 3.17.1. Upon completion of work or correction of discrepancies, an updated status must be submitted to the SUPERVISOR.

#### 4. NOTES:

4.1 ANSI/ISO/ASQ Q9001:2015 commercial third party registrar certification is not required.

4.2 The QMS submitted in 3.2 requires a one-time submittal/acceptance unless this NAVSEA Standard Item and/or references change or contractor's status changes.

4.3 A "zero-tier reference" is a specification, standard, drawing, that is cited in the contract (including its attachments). A "first-tier reference" is either: (1) a specification, standard, or drawing cited in a zero-tier reference, or (2) a specification cited in a first tier drawing. All zero-tier and first tier references are mandatory for use. All lower tier references must be used for guidance only.

4.4 Contractor-run critiques or fact findings are accomplished in accordance with 009-120 of 2.1.

4.5 A partial (G)-point may be accomplished for a fraction of the work specification components. When elected, the contractor is responsible to account for the inspection status of each component. A final (G)-point is required for the last remaining component(s).

4.6 ISO compliant Quality Management Systems typically follow a 4-tiered hierarchy comprised of:

a. "first-tier" document related to the QMS is the Quality Manual, which is the high-level document that is authored and approved by upper management of the organization and is the guiding organizational document for which all subsequent tiers within the system should be aligned with.

- b. The “second-tier” documents are the Quality Procedures making up the center of the documentation system. These procedures span all the required processes and practices within the organization and should include references both upward to the Quality Manual and downward to the Work Instructions associated with each process.
- c. The “third-tier” documents are Work Instructions comprised of instructions that describe the specific actions required to achieve a quality product.
- d. The “fourth-tier” documents are the Quality Records which capture all the data, information, records, forms and become the objective evidence which will prove the QMS is being executed per procedure.

#### 4.7 NAVSEA 04RM3 Approved list of Accrediting Bodies (AB).

- . ANSI-ASQ National Accreditation Board (ANAB), <http://anab.org/>
- . Laboratory Accreditation Bureau (L-A-B), <http://l-a-b.com/>
- . Perry Johnson Registrars (PJLA), <http://www.pjr.com/>
- . The American Association for Laboratory Accreditation (A2LA), <https://www.a2la.org/>
- . National Voluntary Laboratory Accreditation Program (NVLAP), <https://www.nist.gov/nvlap>
- . International Accreditation Service (IAS), <http://www.iasonline.org>

Contact NAVSEA 04RM3 for information on commercial accreditation in accordance with 2.3 by NAVSEA approved commercial Accrediting Bodies (AB).

4.8 Scope: The official and detailed statement of the calibration services for which the laboratory is accredited. Alternative terms include scope of accreditation, scope of competency, and scope of calibrations.



Attachment A  
Work Completion Certification

SHIP'S NAME :	HULL NO.:			
WORK ITEM NO:	SSP NO.:			
<table style="width: 100%; border: none;"> <tr> <td style="width: 15%; vertical-align: top;">KEY EVENT:</td> <td style="width: 5%; text-align: center;"> <input type="checkbox"/>  <input type="checkbox"/>  <input type="checkbox"/>  <input type="checkbox"/>  <input type="checkbox"/>  <input type="checkbox"/>  <input type="checkbox"/>  <input type="checkbox"/>  <input type="checkbox"/>  <input type="checkbox"/> </td> <td style="padding-left: 10px;">           Undocking (UD)            Production Completion Date (PCD)            Dock Trials (DT)            Fast Cruise (FC)            Sea Trials (ST)            Availability Completion (AC)            Command, Control, Communications, Computer, Combat Systems,            and Intelligence Light-Off (C5ILO)            Work Complete (WC)            Other _____         </td> </tr> </table>		KEY EVENT:	<input type="checkbox"/> <input type="checkbox"/> <input type="checkbox"/> <input type="checkbox"/> <input type="checkbox"/> <input type="checkbox"/> <input type="checkbox"/> <input type="checkbox"/> <input type="checkbox"/> <input type="checkbox"/>	Undocking (UD) Production Completion Date (PCD) Dock Trials (DT) Fast Cruise (FC) Sea Trials (ST) Availability Completion (AC) Command, Control, Communications, Computer, Combat Systems, and Intelligence Light-Off (C5ILO) Work Complete (WC) Other _____
KEY EVENT:	<input type="checkbox"/> <input type="checkbox"/> <input type="checkbox"/> <input type="checkbox"/> <input type="checkbox"/> <input type="checkbox"/> <input type="checkbox"/> <input type="checkbox"/> <input type="checkbox"/> <input type="checkbox"/>	Undocking (UD) Production Completion Date (PCD) Dock Trials (DT) Fast Cruise (FC) Sea Trials (ST) Availability Completion (AC) Command, Control, Communications, Computer, Combat Systems, and Intelligence Light-Off (C5ILO) Work Complete (WC) Other _____		

1) All contracted production work (original, new and growth) has been satisfactorily reviewed, accurate and complete. All non-conformances have been corrected and corrective action request (CAR) are at an acceptable level of completion.

RESULTS/STATUS:

- Complete
- Complete w/ Discrepancies
- Incomplete

Note: If work is incomplete or complete with discrepancies, supporting rational and impact statement with recovery plan in the Comments block below.

Comments: \_\_\_\_\_

\_\_\_\_\_

\_\_\_\_\_

\_\_\_\_\_

Print and Sign Name: \_\_\_\_\_ Date: \_\_\_\_\_

Position and Responsibility: \_\_\_\_\_

\_\_\_\_\_

2) All Tests and Inspections have been completed satisfactorily reviewed, accurate, complete and properly documented in the T&I Plan.

RESULTS/STATUS:

- Complete
- Complete w/ Discrepancies
- Incomplete

Note: If work is incomplete or complete with discrepancies, supporting rational and impact statement with recovery plan in the Comments block below.

Comments: \_\_\_\_\_

\_\_\_\_\_  
\_\_\_\_\_  
\_\_\_\_\_

Print and Sign Name: \_\_\_\_\_ Date: \_\_\_\_\_

Position and Responsibility: \_\_\_\_\_

\_\_\_\_\_

3) All required reports and all accompanying required data have been submitted, reviewed, accurate, complete and satisfactory.

RESULTS/STATUS:

- Complete
- Complete w/ Discrepancies
- Incomplete

Note: If work is incomplete or complete with discrepancies, supporting rational and impact statement with recovery plan in the Comments block below.

Comments: \_\_\_\_\_

\_\_\_\_\_  
\_\_\_\_\_  
\_\_\_\_\_

Print and Sign Name: \_\_\_\_\_ Date: \_\_\_\_\_

Position and Responsibility: \_\_\_\_\_

\_\_\_\_\_

## Attachment B

CONTRACTOR QMS MANUAL REVIEW CHECKLIST				
Company's Name:		Document's Date of Submission:		
Reviewer's Name:		Checklist Completion Date:		
(1) Support				
Item	Reference Paragraph	Requirement/Audit Question	Compliant?	Noncompliant?
1.1	NSI 009-04 Para 3.2	Requirement: Does the organization's Quality Management System (QMS) Manual address all elements of ISO 9001:2015?		
		Comments:		
	NSI 009-04 Para 3.2.5	Requirement: Does the documented QMS include a matrix listing the correlation between 2.2 (ISO 9001:2015), 3.2 (A written QMS Manual), and other submitted documents?		
		Comments:		
Item	ISO 9001:2015 Para 7.1.5 NSI 009-04	Monitoring and Measuring Resources		
1.2	ISO 9001:2015 Para 7.1.5.1	Requirement: Does the organization have a documented procedure to determine and provide the resources needed to ensure valid and reliable results, when monitoring or measuring is used to verify the conformity of products and services to requirements?		
		Comments:		
		Requirement: Does the documented procedure ensure that the resources provided are suitable for the specific type of monitoring and measurement activities being undertaken?		
		Comments:		

Attachment B

(1) Support				
Item	Reference Paragraph	Requirement/Audit Question	Compliant?	Noncompliant?
1.2	ISO 9001:2015 Para 7.1.5.1	Requirement: Does the documented procedure ensure that the resources provided are maintained to ensure their continuing fitness for their purpose?		
		Comments:		
	ISO 9001:2015 Para 7.1.5.1	Requirement: Does the organization retain appropriate documented calibration information as evidence of fitness for purpose of the monitoring and measuring equipment?		
		Comments:		
1.3	ISO 9001:2015 Para 7.1.5.2  NSI 009-04 Para 3.2.1.1	Requirement: Does the documented procedure ensure monitoring and measuring equipment is calibrated against devices traceable to international or national measurement standards? (See NSI 009-04 Para 3.2.1.1 for accreditation requirements). When no such standards exist, the basis used for calibration or verification shall be retained as documented information.		
		Comments:		
	ISO 9001:2015 Para 7.1.5.2  NSI 009-04 Para 3.2.1.2	Requirement: Does the documented procedure ensure calibration intervals are assigned to Measuring and Test Equipment used for acceptance testing, meet the requirements of the NAVSEA Metrology Requirements List (METRL), unless alternate calibration intervals were established IAW ANSI/NCSL Z540-3, Requirements for the Calibration of Measuring and Test Equipment?		
		Comments:		
	ISO 9001:2015 Para 7.1.5.2.b	Requirement: Does the documented procedure ensure devices are identified (i.e. tagged with stickers showing calibration status and due date)?		
		Comments:		

Attachment B

(1) Support				
Item	Reference Paragraph	Requirement/Audit Question	Compliant?	Noncompliant?
1.3	ISO 9001:2015 Para 7.1.5.2.c	Requirement: Does the documented procedure ensure all devices are safeguarded from adjustments, damage, or deterioration that would invalidate the calibration status and subsequent measurement results?		
		Comments:		
	ISO 9001:2015 Para 7.1.5.2	Requirement: Does the documented procedure direct and describe how previous measurement results will be validated, if measuring equipment is found to be unfit for intended purposes, and direct appropriate necessary actions?		
		Comments:		
Item	ISO 9001:2015 Para 7.2	Competence		
1.4	ISO 9001:2015 Para 7.2.a	Requirement: Does the organization have a documented procedure to determine the necessary competence of person(s) doing work under its control that affects the performance and effectiveness of the QMS?		
		Comments:		
	ISO 9001:2015 Para 7.2.b	Requirement: Does the organization have a documented procedure in place to ensure that persons are competent on the basis of appropriate education, training, or experience?		
		Comments:		
	ISO 9001:2015 Para 7.2.c	Requirement: Does the organization have a documented procedure to take actions to acquire the necessary competence? If so, does the organization have a procedure to evaluate the effectiveness of those actions taken?		
		Comments:		

Attachment B

(1) Support				
Item	Reference Paragraph	Requirement/Audit Question	Compliant?	Noncompliant?
1.4	ISO 9001:2015 Para 7.2.d	Requirement: Does the organization have a documented procedure to retain appropriate personnel records (i.e. education, training, skills, and experience) as evidence of competence?		
		Comments:		
Item	ISO 9001:2015 Para 7.5 NSI 009-04	QMS Documented Information		
1.5	ISO 9001:2015 Para 7.5.2.a	Requirement: When creating and updating documented procedures, does the organization have a documented procedure to ensure appropriate: a) Identification and description?		
		Comments:		
1.5	ISO 9001:2015 Para 7.5.2.b	Requirement: b) format (e.g. language, software version, graphics) and media (e.g. paper, electronic)?		
		Comments:		
	ISO 9001:2015 Para 7.5.2.c	Requirement: c) review and approval for suitability and adequacy of documented information (i.e. procedures and records)?		
Comments:				
ISO 9001:2015 Para 7.5.3.1	Requirement: Does the organization have a documented procedure to control documented information to ensure its protection (e.g. from loss of confidentiality, improper use, or loss of integrity) and availability at locations essential to the effectiveness of the QMS?			
	Comments:			

Attachment B

(1) Support				
Item	Reference Paragraph	Requirement/Audit Question	Compliant?	Noncompliant?
1.6	ISO 9001:2015 Para 7.5.3.2.a	Requirement: Does the organization's document control procedure: a) address distribution, access, retrieval, and use of documented information?		
		Comments:		
	ISO 9001:2015 Para 7.5.3.2.b	Requirement: b) ensure adequate storage and preservation (including preservation of legibility) of documented information?		
		Comments:		
	ISO 9001:2015 Para 7.5.3.2.c	Requirement: c) control of changes (e.g. version control)?		
Comments:				
ISO 9001:2015 Para 7.5.3.2.d	Requirement: d) retention and disposition of documents? Are obsolete documents prevented from unintended use IAW the approved procedure?			
	Comments:			
ISO 9001:2015 Para 7.5.3.2	Requirement: Does the organization's document control procedure ensure that documents of external origin determined by the organization to be necessary for the planning and execution of the QMS, are identified and controlled?			
	Comments:			

## Attachment B

(1) Support				
Item	Reference Paragraph	Requirement/Audit Question	Compliant?	Noncompliant?
1.6	ISO 9001:2015 Para 7.5.3.2	Requirement: Does the organization's documented procedure ensure documented information is retained as evidence of conformity and the information is protected from unintended alteration?		
		Comments:		

Auditor: _____	Date: _____
Printed Name and Signature	



Attachment C

CONTRACTOR QMS MANUAL REVIEW CHECKLIST				
Company's Name:		Document's Date of Submission:		
Reviewer's Name:		Checklist Completion Date:		
(2) Operation				
Item	Reference Paragraph	Requirement/Audit Question	Compliant ?	Noncompliant?
Item	ISO 9001:2015 Para 8.2	Requirements for Products and Services		
2.1	ISO 9001:2015 Para 8.2.1	Requirement: Does the organization have a documented procedure for customer communication that: a) provides information related to products and services?		
		Comments:		
		Requirement: b) identifies and implements arrangements for inquiries, contracts, and orders, including changes?		
		Comments:		
		Requirement: c) provides for customer feedback relating to products and services, including complaints?		
		Comments:		
		Requirement: d) addresses handling or controlling customer property		
Comments:				

Attachment C

(2) Operation				
Item	Reference Paragraph	Requirement/Audit Question	Compliant ?	Noncompliant?
2.1	ISO 9001:2015 Para 8.2.1	Requirement: e) establishes specific requirements for contingency actions, when relevant?		
		Comments:		
2.2	ISO 9001:2015 Para 8.2.2	Requirement: When determining the requirements for the products and services to be offered to customers, does the organization's documented procedure ensure requirements for products and services offered are defined, including: a) applicable statutory and regulatory requirements and those considered necessary by the		
		Comments:		
	ISO 9001:2015 Para 8.2.3.1	Requirement: b) meeting claims for the products and services it offers?		
		Comments:		
		Requirement: Does the organization's documented procedure direct a review prior to the commitment of the services and products offered to ensure they meet the requirements of the customer, including: a) requirements specified by the customer, including the requirements for delivery and post-		
		Comments:		
ISO 9001:2015 Para 8.2.3.1	Requirement: b) requirements not stated by the customer, but necessary for the specified or intended use, when known?			
	Comments:			

Attachment C

(2) Operation					
Item	Reference Paragraph	Requirement/Audit Question	Compliant ?	Noncompliant?	
2.2	ISO 9001:2015 Para 8.2.3.1	Requirement: c) requirements specified by the organization?			
		Comments:			
		Requirement: d/e) statutory and regulatory requirements applicable to the products and services and contract or order requirements differing from those previously expressed?			
		Comments:			
		Requirement: f) confirmation that contract or order requirements differing from those previously defined are resolved?			
		Comments:			
	ISO 9001:2015 Para 8.2.3.1	Requirement: g) confirmation by the organization before acceptance, when the customer does not provide a documented statement of their requirements?			
		Comments:			
	ISO 9001:2015 Para 8.2.3.2	Requirement: Does the organization's documented procedure ensure the results of the review for products and services and any new requirements for products and services are documented?			
		Comments:			

Attachment C

(2) Operation				
Item	Reference Paragraph	Requirement/Audit Question	Compliant ?	Noncompliant?
2.2	ISO 9001:2015 Para 8.2.4	Requirement: Does the organization's documented procedure ensure that relevant documented information is amended and relevant persons are made aware of the changed requirements when customer requirements for products and services change?		
Comments:				
Item	ISO 9001:2015 Para 8.4, NSI 009-04	Control of Externally Provided Processes, Products, and Services		
2.3	ISO 9001:2015 Para 8.4.1	Requirement: Does the organization's documented procedure ensure that externally provided processes, products, and service conform to requirements and determine the controls to be applied to externally provided processes, products, and services when: a) products and services from external providers are intended for incorporation into the		
		Comments:		
		Requirement: b) products and services are provided directly to the customer(s) by external providers on behalf of the organization?		
		Comments:		
		Requirement: c) a process, or part of a process, is provided by an external provider as a result of a decision by the organization?		
		Comments:		
		Requirement: Does the organization's documented procedure determine and apply criteria for the evaluation, selection, monitoring of performance, and re-evaluation of external providers, based on their ability to provide processes or products and services in accordance with requirements? Does the organization retain documented information of external providers and		

Attachment C

(2) Operation				
Item	Reference Paragraph	Requirement/Audit Question	Compliant ?	Noncompliant?
		Comments:		

Attachment C

(2) Operation				
Item	Reference Paragraph	Requirement/Audit Question	Compliant ?	Noncompliant?
2.4	ISO 9001:2015 Para 8.4.2	Requirement: Does the organization's documented procedure ensure that externally provided processes, products, and services do not adversely affect the organization's ability to consistently deliver conforming products and services to its customers? The procedure shall: a) ensure that externally provided processes are controlled by their QMS?		
		Comments:		
		Requirement: b) define both the controls that it intends to apply to an external provider and those it intends to apply to the resulting output?		
		Comments:		
		Requirement: c.1) take into consideration potential impact of the externally provided processes, products, and services on the organization's ability to consistently meet customer and applicable statutory and regulatory requirements?		
		Comments:		
		Requirement: c.2) take into consideration the effectiveness of the controls applied by the external provider?		
		Comments:		
		Requirement: determine the verification, or other activities, necessary to ensure that the externally provided processes, products, and service meet requirements?		
Comments:				

Attachment C

(2) Operation				
Item	Reference Paragraph	Requirement/Audit Question	Compliant ?	Noncompliant?
2.4	NISI 009-04 Para 3.2.2.2	Requirement: Does the organization have a process for Receipt Inspection of CFM based on supplier performance history and one or more of the following: certificate of compliance, vendor material test certification data, manufacturer's MIL certificate, or testing using sampling techniques?		
		Comments:		
2.5	ISO 9001:2015 Para 8.4.3	Requirement: Does the organization's documented procedure ensure the adequacy of requirements prior to their communication to the external provider? The procedures shall communicate to external providers it's requirements for: a) the processes, products, and services to be provided		
		Comments:		
	ISO 9001:2015 Para 8.4.3	Requirement: b) the approval of: 1. products and services 2. methods, processes, and equipment 3. the release of products and services		
		Comments:		
	ISO 9001:2015 Para 8.4.3	Requirement: c) competence including any required qualification of persons		
		Comments:		
	ISO 9001:2015 Para 8.4.3	Requirement: d) the external provider's interactions with the organization		
		Comments:		

Attachment C

(2) Operation				
Item	Reference Paragraph	Requirement/Audit Question	Compliant ?	Noncompliant?
2.5	ISO 9001:2015 Para 8.4.3	Requirement: e) control and monitoring of the external provider's performance to be applied by the organization		
		Comments:		
	ISO 9001:2015 Para 8.4.3	Requirement: f) the verification or validation activities that the organization, or its customer, intends to perform at the external providers' premises.		
		Comments:		
	NSI 009-04 Para 3.2.2.1	Requirement: The organization's documented procedure identifies, in purchasing documents, verification arrangements at the SKTR/vendor location/premises IAW NSI 009-04 Para 3.2.2.1?		
		Comments:		
Item	ISO 9001:2015 Para 8.5	Production and Service Provision		
2.6	ISO 9001:2015 Para 8.5.1	Requirement: Does the organization's documented procedure implement production and service provision under controlled conditions? Controlled conditions include: a) the availability of documented information that defines: 1) the characteristics of the products to be produced, the services to be provided, or the activities to be performed;		
		Comments:		
		Requirement: b) the availability and use of suitable monitoring and measuring resources		



Attachment C

(2) Operation				
Item	Reference Paragraph	Requirement/Audit Question	Compliant ?	Noncompliant?
		Comments:		

Attachment C

(2) Operation					
Item	Reference Paragraph	Requirement/Audit Question	Compliant ?	Noncompliant?	
2.6	ISO 9001:2015 Para 8.5.1	Requirement: c) the implementation of monitoring and measurement activities at appropriate stages to verify that criteria for control of processes or outputs, and acceptance criteria for products and services, have been met			
		Comments:			
		Requirement: d) the use of suitable infrastructure and environment for the operation of processes			
		Comments:			
		Requirement: e) the appointment of competent persons, including any required qualification			
		Comments:			
		Requirement: f) the validation, and periodic revalidation, of the ability to achieve planned results of the processes for production and service provision, where the resulting output cannot be verified by subsequent monitoring or measurement			
		Comments:			
		Requirement: g) the implementation of actions to prevent human error			
		Comments:			

Attachment C

(2) Operation				
Item	Reference Paragraph	Requirement/Audit Question	Compliant ?	Noncompliant?
2.6	ISO 9001:2015 Para 8.5.1	Requirement: h) the implementation of release, delivery, and post-delivery activities		
		Comments:		
2.7	ISO 9001:2015 Para 8.5.2	Requirement: Does the organization's documented procedure specify suitable means to identify outputs, when necessary, to ensure the conformity of products and services?		
		Comments:		
		Requirement: Does the organization's documented procedure identify the status of outputs, with respect to monitoring and measurement requirements throughout production and service provision?		
		Comments:		
		Requirement: When traceability is a requirement, does the organization's documented procedure control and record the unique identification of the product?		
Comments:				
2.8	ISO 9001:2015 Para 8.5.3	Requirement: For property belonging to customers or external providers, does the organization's documented procedure ensure: a) the exercise of care with property belonging to customers or external providers while it is under the organization's control or being used by the organization?		
		Comments:		

Attachment C

(2) Operation				
Item	Reference Paragraph	Requirement/Audit Question	Compliant ?	Noncompliant?
2.8	ISO 9001:2015 Para 8.5.3	Requirement: b) the identification, verification, protection, and safeguarding of customers' or external providers' property provided for use or incorporation into the products and services?		
		Comments:		
		Requirement: c) that when the property of a customer or external provider is lost, damaged, or otherwise found to be unsuitable for use, the organization reports this to the customer or external provider and retain documented information on what has occurred?		
		Comments:		
	ISO 9001:2015 Para 8.5.4	Requirement: Does the organization's documented procedure preserve the outputs during production and service provision, to the extent necessary to ensure conformity of product with customer requirements?		
		Comments:		
	ISO 9001:2015 Para 8.5.5	Requirement: Does the organization's documented procedure have a process to meet post-delivery activities associated with the products and services? The organization shall consider: a) statutory and regulatory requirements		
		Comments:		
		Requirement: b) the potential undesired consequences associated with its products and services		
		Comments:		

Attachment C

(2) Operation					
Item	Reference Paragraph	Requirement/Audit Question	Compliant ?	Noncompliant?	
2.8	ISO 9001:2015 Para 8.5.5	Requirement: c) the nature, use, and intended lifetime of its products and services;			
		Comments:			
		Requirement: d) customer requirements			
		Comments:			
		Requirement: e) customer feedback.			
		Comments:			
	ISO 9001:2015 Para 8.5.6	Requirement: Does the organization's documented procedure require review and control of changes for production or service provision, to the extent necessary to ensure continuing conformity with requirements and retain documented information of the review of changes, the person(s) authorizing the change, and any necessary actions arising from the review?			
Comments:					
Item	ISO 9001:2015 Para 8.6	Release of Products and Services			
2.9	ISO 9001:2015 Para 8.6	Requirement: Does the organization's documented procedure implement planned arrangements at appropriate stages, to verify product and service requirements are met?			

Attachment C

(2) Operation				
Item	Reference Paragraph	Requirement/Audit Question	Compliant ?	Noncompliant?
		Comments:		

Attachment C

(2) Operation					
Item	Reference Paragraph	Requirement/Audit Question	Compliant ?	Noncompliant?	
2.9	ISO 9001:2015 Para 8.6	Requirement: Does the organization's documented procedure ensure the release of products and services to the customer proceed only after the planned arrangements have been satisfactorily completed, unless otherwise approved by a relevant authority and, as applicable, by the customer?			
		Comments:			
		Requirement: Does the organization's documented procedure require the retention of relevant documented information, including the evidence of conformity with the acceptance criteria, and traceability to the person(s) authorizing the release?			
		Comments:			
Item	ISO 9001:2015 Para 8.7	Control of Nonconforming Outputs			
2.10	ISO 9001:2015 Para 8.7.1	Requirement: Does the organization's documented procedure ensure that nonconforming outputs are identified and controlled to prevent their unintended use or delivery?			
		Comments:			
		Requirement: Does the organization's documented procedure deal with nonconforming outputs in one or more of the following ways, based on the nature of the nonconformity and its effect on the conformity of products and services (this shall also apply to nonconforming products and services detected after delivery of products, during or after the provision of services):			
		Comments:			
		Requirement: b) segregation, containment, return, or suspension of provision of products and services			

Attachment C

(2) Operation				
Item	Reference Paragraph	Requirement/Audit Question	Compliant ?	Noncompliant?
		Comments:		



Attachment C

(2) Operation						
Item	Reference Paragraph	Requirement/Audit Question	Compliant ?	Noncompliant?		
2.10	ISO 9001:2015 Para 8.7.1	Requirement: c) informing the customer				
		Comments:				
		Requirement: d) and/or obtaining authorization for acceptance under concession?				
		Comments:				
		Requirement: Does the organization's documented procedure ensure verification of conformity to the requirements, when nonconforming outputs have been corrected?				
		Comments:				
		Requirement: Does the organization's documented procedure require retention of documented information that: a) describes the nonconformance?				
		Comments:				
		Requirement: b) describes actions taken?				
		Comments:				

Attachment C

(2) Operation					
Item	Reference Paragraph	Requirement/Audit Question	Compliant ?	Noncompliant?	
2.10	ISO 9001:2015 Para 8.7.1	Requirement: c) describes concessions obtained?			
		Comments:			
		Requirement: d) identifies the authority deciding the action in respect to the nonconformity?			
		Comments:			
Auditor: _____		Date: _____			
Printed Name and Signature					

## Attachment D

CONTRACTOR QMS MANUAL REVIEW CHECKLIST				
Company's Name:		Document's Date of Submission:		
Reviewer's Name:		Checklist Completion Date:		
(3) Performance Evaluation & Improvement				
Item	Reference Paragraph	Requirement/Audit Question	Compliant?	Noncompliant?
Item	ISO 9001:2015 Para 9.2	Internal Audit		
3.1	ISO 9001:2015 Para 9.2.1	Requirement: Does the organization's documented procedure require internal quality audits be performed at planned intervals to ensure the QMS: a) conforms to: 1. the organization's own requirements for its QMS? 2. the requirements of ISO 9001:2015? 3. the requirements of NSI 009-04?		
		Comments:		
		Requirement: b) is effectively implemented and maintained?		
		Comments:		
	ISO 9001:2015 Para 9.2.2	Requirement: Does the organization's documented procedure: a) plan, establish, implement, and maintain an audit program(s) including the frequency, methods, responsibilities, planning requirements and reporting, which shall take into consideration the importance of the processes concerned, changes affecting the organization, and the results of previous audits?		
		Comments:		
		Requirement: b) define the audit criteria and scope for each audit?		
		Comments:		

Attachment D

(3) Performance Evaluation & Improvement				
Item	Reference Paragraph	Requirement/Audit Question	Compliant?	Noncompliant?
3.1	ISO 9001:2015 Para 9.2.2	Requirement: c) select auditors and conduct audits to ensure objectivity and the impartiality of the audit process?		
		Comments:		
		Requirement: d) ensure that the results of the audits are reported to relevant management?		
		Comments:		
		Requirement: e) take appropriate correction and corrective actions without undue delay?		
		Comments:		
		Requirement: f) retain documented information as evidence of the implementation of the audit program and the comments?		
		Comments:		
Item	ISO 9001:2015 Para 9.3	Management Review		
3.2	ISO 9901:2015 Para 9.3.1	Requirement: Does the organization's documented procedure require top management to review the organization's QMS at planned intervals, to ensure its continuing suitability, adequacy, effectiveness, and alignment with the strategic direction of the organization?		
		Comments:		

Attachment D

(3) Performance Evaluation & Improvement				
Item	Reference Paragraph	Requirement/Audit Question	Compliant?	Noncompliant?
3.2	ISO 9001:2015 Para 9.3.2	Requirement: Is the organization's management review documented procedure planned and carried out taking into consideration: a) the status of actions from previous management reviews		
		Comments:		
		Requirement: b) changes in external and internal issues that are relevant to the QMS;		
		Comments:		
		Requirement: c) information on the performance and effectiveness of the QMS, including trends in: 1) customer satisfaction and feedback from relevant interested parties 2) the extent to which quality objectives have been met 3) process performance and conformity of products and services 4) nonconformities and corrective actions 5) monitoring and measurement results 6) audit results 7) the performance of external providers		
		Comments:		
		Requirement: d) the adequacy of resources		
		Comments:		
		Requirement: e) the effectiveness of actions taken to address risks and opportunities (see 6.1 of ISO 9001:2015)		
		Comments:		

Attachment D

(3) Performance Evaluation & Improvement					
Item	Reference Paragraph	Requirement/Audit Question	Compliant?	Noncompliant?	
3.2	ISO 9001:2015 Para 9.3.2	Requirement: f) opportunities for improvement?			
		Comments:			
	ISO 9001:2015 Para 9.3.3	Requirement: Does the organization's management review documented procedure include decisions and actions related to: a) opportunities for improvement?			
		Comments:			
		Requirement: b) any need for changes to the QMS?			
		Comments:			
		Requirement: c) resource needs?			
		Comments:			
		Requirement: Does the organization's documented procedure require retention of the results of the management reviews?			
		Comments:			

Attachment D

(3) Performance Evaluation & Improvement				
Item	Reference Paragraph	Requirement/Audit Question	Compliant?	Noncompliant?
Item	ISO 9001:2015 Para 10.2	Nonconformance and Corrective Action		
3.3	ISO 9001:2015 Para 10.2.1	Requirement: Does the organization's documented procedure require, when a nonconformance occurs, including any arising from complaints, the organization to: a) react to the nonconformity and, as applicable: 1) take action to control and correct it 2) deal with the consequences?		
		Comments:		
		Requirement: b) evaluate the need for action to eliminate the cause(s) of the nonconformity, in order that it does not recur or occur elsewhere, by: 1) reviewing and analyzing the nonconformity; 2) determining the causes of the nonconformity; 3) determining if similar nonconformities exist or could potentially occur?		
		Comments:		
		Requirement: c) implement any action needed?		
		Comments:		
		Requirement: d) review the effectiveness of any corrective action taken?		
		Comments:		
		Requirement: e) update risks and opportunities determined during planning, if necessary?		
		Comments:		

Attachment D

(3) Performance Evaluation & Improvement					
Item	Reference Paragraph	Requirement/Audit Question	Compliant?	Noncompliant?	
3.3	ISO 9001:2015 Para 10.2.1	Requirement: f) make changes to the QMS, if necessary?			
		Comments:			
		Requirement: Does the documented procedure require that the Corrective Actions are appropriate to the effects of the nonconformities encountered?			
		Comments:			
	ISO 9001:2015 Para 10.2.2	Requirement: Does the organization's documented procedure require retention of documented information about: a) the nonconformance and corrective action taken?			
		Comments:			
		Requirement: b) results of the corrective actions?			
		Comments:			
Auditor: _____		Date: _____			
Printed Name and Signature					



Attachment E

Root Causes	Category Description
<ul style="list-style-type: none"> <li>• Personnel                             <ul style="list-style-type: none"> <li>○ Work Practices</li> <li>○ Training</li> <li>○ Supervision</li> </ul> </li> <li>• Procedures</li> <li>• Design                             <ul style="list-style-type: none"> <li>○ Technical Documentation</li> </ul> </li> <li>• Material</li> </ul>	<ul style="list-style-type: none"> <li>• Work Practices- Craftsman knows or understands the requirements, but fails to follow them</li> <li>• Training- Training of employees and subcontractors.</li> <li>• Supervision- Lack of preparation or follow through for the original planned event.</li> <li>• Procedures- Issues with procedures provided by outside agency or another activity utilized during the unplanned event.</li> <li>• Tech Documentation- Issues with DWGs, Specifications or Design aspect.</li> <li>• Material- Failure of material to perform under designed conditions and uses.</li> </ul>
Category	Attribute
Work Practices	<ul style="list-style-type: none"> <li>• Failure to follow Procedure</li> <li>• Use of incorrect or outdated Procedures</li> <li>• Inattention to detail</li> <li>• Improper tools/use of tools</li> </ul>
Training	<ul style="list-style-type: none"> <li>• Nonexistent training or qualification</li> <li>• Content is inadequate</li> <li>• Inadequate training or qualification frequency</li> </ul>
Supervision	<ul style="list-style-type: none"> <li>• Assignment of unqualified personnel</li> <li>• Inadequate direction provided</li> <li>• Inadequate review of worksite or Documents</li> </ul>
Procedures	<ul style="list-style-type: none"> <li>• Procedure contains inadequate or unclear direction</li> <li>• Procedure contains incorrect direction</li> </ul>
Technical Documentation	<ul style="list-style-type: none"> <li>• Error in Drawing or Technical Document</li> <li>• Design deficiency</li> </ul>
Material	<ul style="list-style-type: none"> <li>• Material Failure</li> </ul>

NAVSEA  
STANDARD ITEM

FY-24

ITEM NO: 009-05  
DATE: 25 OCT 2022  
CATEGORY: I

1. SCOPE:

1.1 Title: Temporary Access; accomplish

2. REFERENCES:

2.1 Standard Items

2.2 MIL-STD-1689, Fabrication, Welding, and Inspection of Ships Structure

2.3 29 CFR 1915, Occupational Safety and Health Standards for Shipyard Employment

2.4 S9086-DA-STM-010/CH-100, Hull Structures

3. REQUIREMENTS:

3.1 Submit one legible drawing or sketch of each proposed temporary access cut to the ship structure or engine enclosure and a list of each proposed bolted/riveted access removal to the SUPERVISOR 3 days prior to making the cuts or removing the bolted/riveted access. For a nuclear-powered vessel, submit drawing/sketch of each proposed temporary access cut to the SUPERVISOR 5 days prior to making cut or removing the bolted/riveted access. (See Note 4.2 and 4.3)

3.1.1 Submittal of drawing or sketch is not required for those access cuts authorized on a NAVSEA-approved drawing.

3.1.2 The drawing or sketch must include, as a minimum, the following information:

3.1.2.1 A plan and elevation view specifying the location of the access by deck, frame, and distance from the center line or deck edge and showing location of adjacent penetrations, bulkheads, framing, welds, and riveted joints within 12 inches of the proposed cut.

3.1.2.2 Location and number of previous cuts visible in each plate and the cutback of existing welds as required by 2.2.

3.1.2.3 Temporary structural reinforcement required to prevent distortion of ship structure.

3.1.2.4 Thickness and type of material of plating and structural members to be cut. Include source or document/drawing number which identifies material requirements.

3.1.2.5 A description of the temporary access closure or enclosure.

3.1.2.6 Include a copy of the weld procedure or approved weld procedure number with the proposed access sketch.

3.1.3 List of bolted/riveted access covers must include location, designation, and classification as identified on ship's damage control book.

3.1.4 Provide all drawing titles and numbers (including applicable sub-tier), and technical documentation used to accomplish the requirements of 3.1.

3.1.5 Temporary accesses include access plates, small access plates, and closure plates as defined in Paragraph 3.33 of 2.2.

3.2 Ensure that access cut boundaries conform to the requirements of 2.2, 2.4 and the following:

3.2.1 Boundaries may extend across one or more frames as required for size of opening.

3.2.2 Are sized and located to accomplish the requirements of the Job Order.

3.2.2.1 Verify access requirements on NAVSEA drawings conform to these same requirements.

3.2.3 Weld riveted plates using a single V-weld with glass cloth conforming to MIL-C-24576, Type One, Class One, to prevent fusion between backing member and plate.

3.2.3.1 Remove existing rivets within 6 inches of a cut and install new rivets in accordance with 2.2.

3.2.3.2 Round patches 2 feet in diameter or less must be dished 1/16-inch to 1/8-inch.

3.2.4 Minimum width of small access plates must be at least 4 times the material thickness of the plate being cut or 3 inches, whichever is greater.

3.2.5 Corners of small access plates between 3 inches minimum to 6 inches maximum in width must have a radius of one-half the width. Exception to this corner radius criterion is where a boundary terminates on an existing hull longitudinal seam or transverse butt joint.

3.2.6 Corners of small access plates greater than 6 inches in width must have a radius of 2 times the material thickness of the plate being cut or 3 inches, whichever is greater. Exception to this corner radius criterion is where a boundary terminates on an existing hull longitudinal seam or transverse butt joint.

3.2.7 Corners of access plates must have a minimum radius of 6 inches. Exception to this corner radius criterion is where a boundary terminates on an existing hull longitudinal seam or transverse butt joint.

3.2.8 Utilize the same boundaries as used for prior cuts unless the requirements of this Standard Item have been violated.

3.2.8.1 Annotate violations on the drawing or sketch required by 3.1.

3.2.9 Location restrictions and limitations on number of temporary accesses allowed per tank must conform to the requirements of 100-2.9.1 of 2.4.

(V)(G) "INSPECT LAY OUT"

3.3 Lay out access on both sides of the structure to be cut, in accordance with the approved drawing or sketch.

3.4 Prior to cutting access in the ship/vessel's structure and after layout checkpoint, accomplish positive verification by drilling a pilot hole in the path of the cut to be accomplished.

3.5 Center punch access layout upon completion of verification in 3.4.

3.6 Accomplish the requirements of 2.3 for guarding of access openings.

3.6.1 Remove temporary guarding after installation of access plates. Chip and grind surfaces flush in way of removals.

3.7 Install a temporary coaming with a minimum height of 4 inches around access cuts through decks. Tack-weld the coaming to the deck and seal the deck joint with caulking compound.

3.7.1 Remove the temporary coaming after installation of access plate. Chip and grind surfaces flush in way of removals.

3.8 Cut access in accordance with the approved drawing or sketch.

3.9 Remove bolted/riveted access.

3.9.1 Clean and preserve gasket faying surfaces.

3.9.2 Chase and tap exposed threaded areas.

3.10 Protect ship from weather and contamination.

3.10.1 Fabricate temporary closures using fire retardant material, prior to removing plates or cutting access openings.

3.10.1.1 Closures must be constructed to protect the access from inclement weather and entry of contaminants.

3.10.1.2 Horizontal deck closures must support a minimum of 150 pounds per square foot.

3.10.1.3 Closures must be fitted with fasteners that permit rapid installation and removal.

3.10.2 Install closures whenever access is not in use.

3.11 Maintain watertight integrity of waterborne ship.

3.11.1 Fabricate and install watertight enclosures prior to removing plates or cutting access openings that do not provide a minimum of 4 feet of freeboard.

3.11.1.1 Maintain watertight integrity to a level 4 feet above the maximum calculated draft.

3.12 Maintain watertight integrity of ship in dry dock.

3.12.1 Provide temporary access closure plates and fasteners prior to removing plates or cutting access openings below 4 feet of waterborne freeboard.

3.12.1.1 Closure plates must be available on short notice for emergency sealing of the temporary access openings.

3.12.2 Seal access openings with closure plates when conditions warrant.

3.12.3 Secure openings at the end of each shift not immediately followed by another shift engaged in dry dock work.

3.13 Remove the temporary closures when no longer required.

3.14 Install the temporary access removed in 3.8 and 3.9 in accordance with the approved drawing or sketch.

3.14.1 Accomplish the requirements of 009-12 of 2.1 for welding, fabrication, and inspection requirements to support installation of a temporary access.

3.14.2 Install the bolted/riveted access.

3.14.2.1 Use new gasket material in accordance with NAVSEA approved drawings.

3.14.2.2 Install new rivets for riveted access plates in accordance with 2.2.

3.15 Accomplish the requirements of 009-25 of 2.1 for chalk test on each structural closure in way of temporary access.

3.16 Accomplish the requirements of 009-25 of 2.1 for structural boundary testing of each watertight/airtight temporary access closure (e.g. cofferdam, vacuum box, air hose, and water hose).

4. NOTES:

4.1 Maximum Calculated Draft (MCD) – The maximum draft, calculated during the period in which ship’s draft is affected due to evolutions which add, remove, or change weight. It represents the “worst case” cumulative effect at any one time on trim, list, or draft for the proposed weight changes throughout the period that hull penetrations are in a non-standard configuration. MCD must be known and utilized by the SUPERVISOR and Ship’s Force in scheduling work and testing during waterborne maintenance periods.

4.2 Drawings provide detailed representations of the proposed area of the access cut rendered to scale. They include exact dimensional data and are normally produced using drawing instruments (i.e., from compasses to computers).

4.3 Sketches are simplified or basic drawings. They are normally locally produced but still fulfill all requirements from this NSI (3.1.2.1 through 3.1.2.6) for the proposed area of the access cut.

NAVSEA  
STANDARD ITEM

FY-24

ITEM NO: 009-06

DATE: 25 OCT 2022

CATEGORY: I

1. SCOPE:

1.1 Title: Maintaining Protection and Cleanliness from Non-Radioactive Operations;  
accomplish

2. REFERENCES:

2.1 MIL-STD-1623, Fire Performance Requirements and Approved Specifications for  
Interior Finish Materials and Furnishings (Naval Shipboard Use)

2.2 NFPA Standard 701, Standard Methods of Fire Tests for Flame Propagation of Textiles  
and Films

3. REQUIREMENTS:

3.1 Observe the following requirements, in addition to the specific requirements of  
the Job Order, for maintaining protection and cleanliness from non-radioactive operations on  
the ship, ship's equipment, components, and spaces for the duration of the availability.

3.1.1 Accomplish an inspection of the work area prior to installation of  
protective covering to identify the current condition of equipment, systems, and  
components, including any exposed cables, penetrations, stuffing tubes, bolted cover  
plates, and antennas.

3.1.1.1 Submit one legible copy, in hard copy or approved transferrable  
media, of a report listing results of the requirements of 3.1.1 to the SUPERVISOR.

3.2 Prevent contamination and damage of the ship's equipment,  
components, and spaces during contamination-producing operations.

3.2.1 Plug, blank, wrap, cover, seal, and mask equipment, components, cables,  
wireways, boots, and openings using fire retardant/water repellent material, and prevent entry  
of contaminants to components, systems and equipment.

3.2.1.1 Ensure plugging and blanking does not result in flooding or damage to ship's equipment.

3.2.1.2 Protect ship's equipment by installing Herculite or canvas covering conforming to A-A-55308, and/or fire retardant plywood conforming to Category 2, Type II, of MIL-L-19140, or other NAVSEA-approved fire retardant industrial protective material within the proximity to hot work and non-fabric material that conforms with 2.1 and is tested in accordance with and meets the requirements of 2.2 when used onboard for containment or as protective coverings not within the proximity of hot work.

3.2.2 Install fire retardant industrial filter material meeting the minimum requirements of UL 900 Class 1, non-fire contributing material, on the intake of supply and exhaust end of ventilation systems that will be in use.

3.2.2.1 Remove existing and install new filter or clean the filter material when air flow is restricted.

3.2.3 Ensure all protective measures are to be in place prior to start of any contamination-producing operations and must remain in place until the contamination-producing operations are complete.

3.2.4 Install double curtain baffles at the entrance of each access door where airborne contamination could occur during contamination-producing operations. Install a dirt collecting mat on the deck directly inside each door. The SUPERVISOR will select a maximum of 4 doors. Secure and mark doors not designated for access.

3.2.5 Ensure temporary coverings are not removed during contamination-producing operations without permission of the SUPERVISOR.

3.3 Maintain the integrity of the protective covering at the beginning of each shift in which contamination-producing operations will be accomplished. Ensure that equipment and machinery have not been infiltrated by contaminants. Notify the SUPERVISOR immediately by verbal means, followed on the next day in writing, if contamination or surface damage has occurred. Reseal to prevent further entry of contaminants or surface damage.

3.4 Maintain cleanliness of the work site, including bilges, free from accumulation of industrial debris caused by contractor and/or subcontractor employees on a continuous basis throughout the availability. Work spaces include those areas immediately under and adjacent, and those areas where service lines are run, and bilge areas in vicinity of the work site.

3.4.1 Cleaning must be accomplished no later than at the end of each shift at a minimum, on a daily basis.



3.4.2 Remove and dispose of industrial debris from the ship at the end of each shift at a minimum, on a daily basis.

3.5 Remove protective covering installed in 3.2 upon completion of contamination-producing operations. Identify any presence of contamination or damage created by contamination producing operations. Contamination/damage must be documented on the inspection record.

3.5.1 Presence of contamination and/or damage created by contamination-producing operations is unacceptable and must be corrected.

3.6 Remove from the ship and dispose of debris and foreign matter generated as a result of work being accomplished at the end of each shift at a minimum, on a daily basis. Comply with the requirements of federal, state, and local laws, codes, ordinances, and regulations or as specified elsewhere in the Job Order.

#### 4. NOTES:

##### 4.1 Definitions:

4.1.1 Cleanliness means the removal of all industrial debris (industrial trash, waste material, weld rods/tips, fasteners, rags, lagging waste, job scrap, wire, litter, rubbish, etc.) at the end of each shift, leaving the areas broom clean and electronic spaces vacuum clean. Adjacent/surrounding machinery, equipment, etc., must be cleaned free of all resulting debris.

4.1.2 Daily means at least once per every calendar day.

4.1.3 Non-radioactive operations include but are not limited to:

4.1.3.1 Operations liable to produce particulates to become airborne during accomplishment of the work scope, i.e., abrasive blasting, mechanical cleaning, spray painting, hot work operations, and air blowdowns.

4.1.3.2 Operations liable to produce fluid contamination of equipment as a result of external leakage of piping systems during testing.

4.1.3.3 Operations liable to produce fluid contamination of equipment as a result of external leakage of piping systems during waterjetting.

4.1.3.4 Operations liable to produce industrial debris such as, but not limited to, industrial trash, waste material, weld rods/tips, fasteners, rags, lagging waste, job scrap, wire, litter, rubbish, etc.

4.2 The SUPERVISOR will coordinate operation of ventilation systems, as requested by the contractor, to maintain a positive pressure within the vessel's envelope and to create an

outward flow of air through crevices or around penetrations.

4.3 The cleanliness goal is to turn over all areas of the ship in the same condition or better as at beginning of the availability.

4.4 Ship's Force responsibility:

4.4.1 Ship's Force is responsible for dust that collects as a matter of course throughout the availability and for any Ship's Force work site maintenance including monitoring work sites being worked by intermediate maintenance activities, Alteration Installation Teams (AIT), and any contractor services that the ship has arranged.

4.4.2 Ship's Force is responsible to maintain cleanliness of their areas of responsibility broom clean at the end of each shift, on a daily basis.

4.4.3 Ship's Force will report cleanliness concerns to the SUPERVISOR for contractor responsible areas.

4.4.4 Ship's Force will work continually throughout the availability to keep bilges and other general areas of the ship clean where the Contractor is not working.

4.5 Ship's Force and the Contractor will familiarize each other with their scope of work (any other work being performed on board the ship not pursuant to contractor authorized work under the Job Order is considered Ship's Force work). The affected locations and aspects of the work and/or ship conditions (i.e., blasting, grinding, preservation, hot work, insulation removals, decking replacement, hydroblasting, weight tests, electrical cable replacement, etc.) will be identified. Each responsible party will clean site in locations where both parties will be working, on a daily basis. Communications must be continuous and active 2 ways.

4.6 Diligence in inspection will ensure that action is taken by the responsible party prior to any area becoming unsatisfactory.

NAVSEA  
STANDARD ITEM

FY-24

ITEM NO: 009-07  
DATE: 25 OCT 2022  
CATEGORY: I

1. SCOPE:

1.1 Title: Confined Space Entry, and Certification; accomplish

2. REFERENCES:

2.1 Standard Items

2.2 29 CFR Part 1915, Occupational Safety and Health Standards for Shipyard Employment

2.3 29 CFR Part 1910.134, Occupational Safety and Health Standards, Respiratory Protection

2.4 NFPA Standard 312, Standard for Fire Protection of Vessels During Construction, Repair, and Lay-up

2.5 American Conference of Government Industrial Hygienists (ACGIH) Threshold Limit Values for Chemical Substances and Physical Agents

3. REQUIREMENTS:

3.1 Comply with the requirements of 2.2 through 2.4 and this item to determine whether or not an explosive or other dangerous atmosphere exists in tanks, spaces, and associated piping, including adjacent tanks, spaces, and piping aboard the ship and control hot work and entry to those spaces to preclude damage to the ship or injury to personnel during the accomplishment of this Job Order.

3.1.1 Submit one legible copy, in approved transferrable media, of a list of tanks or spaces to be opened or certified to the SUPERVISOR at least one day prior to opening the tank or void.

3.1.1.1 Comply with additional requirements of NAVSEA Standard Items when accomplishing work in Collection, Holding and Transfer (CHT) and Motor Gasoline (MOGAS) tanks, spaces, or associated piping.

3.1.1.2 For fuel tanks or spaces that contain or have contained fuel, including F-76 and JP-5, in addition to the atmospheric testing required by 2.2, test for diesel fuel (CAS No. 68334-30-5; 68476-30-2; 68476-31-3; 68476-34-6, 77650-28-3) as total hydrocarbons in accordance with 2.5, and record total hydrocarbon test results on the Marine Chemist Certificate or competent person's test/inspection record.

3.1.2 Provide initial and annual update training for Competent Persons by utilizing a National Fire Protection Association (NFPA) Certified Marine Chemist or NFPA Instructor. The length of the initial training class must be at least 24 hours. Annual update training must be at least 8 hours.

3.1.2.1 Maintain a current roster of designated Competent Person(s) and copies of certificates of completion for the training required in 3.1.2 for reference by the SUPERVISOR. Submit one legible copy, in approved transferrable media, of the specific documents when requested by the SUPERVISOR.

3.1.3 Post a copy of the Marine Chemist Certificate, Certified Industrial Hygienist's test/inspection record, or Competent Person's test/inspection record at each access to the affected space while work in the space is in progress. When requested, a copy of the MCC or test/inspection record must also be delivered to a location designated by the SUPERVISOR. In the event that the space is identified to be NOT SAFE FOR WORKERS or NOT SAFE FOR HOT WORK, the space must be posted accordingly and other affected contractors, the SUPERVISOR and Ship's Force must be notified immediately. The posted copy must be clearly visible and legible.

3.1.3.1 Initial certification of spaces that require a Certified MCC or Certified Industrial Hygienist's test/inspection record in support of work operations must be effective until conditions change which would void the certificate or test/inspection record. A Competent Person must conduct the same atmospheric testing as required on the MCC or Certified Industrial Hygienist's test/inspection record.

3.1.3.2 For those certified spaces which employees will enter, a Competent Person must visually inspect, test and record each space certified as ENTER WITH RESTRICTIONS or SAFE FOR WORKERS as often as necessary, and as a minimum, prior to entry by employees on a daily basis. If a space is not to be entered on any given day, it is not required to be inspected and tested by a Competent Person. The initial MCC remains valid if conditions have not changed, unless noted on the MCC.

3.1.3.3 For those certified spaces affected by hot work, a Competent Person must visually inspect, test, and record each space certified as SAFE FOR HOT WORK as often as necessary and, as a minimum, daily prior to commencement of hot work to ensure that conditions established by the certificate are maintained. When hot work is continuous, the affected spaces must be visually inspected, tested, and recorded on a daily basis to maintain the SAFE FOR HOT WORK certification.

3.1.3.4 If a Competent Person finds that the conditions within a certified space fail to meet the applicable requirements for which it was certified, work in the space must be stopped and may not be resumed until the space has been recertified by a Marine Chemist.

3.1.3.5 For those spaces where only Competent Person tests and inspections are required in accordance with 2.2, a Competent Person must visually inspect and test each space as often as necessary and, as a minimum, daily prior to entry or commencement of hot work to ensure that conditions are safe.

3.1.3.6 After the Competent Person has determined initially that a space is safe for entry and finds subsequently that the conditions within the tested space fail to meet the requirements of 2.2, work must be stopped until the conditions in the tested space are corrected, the space is retested, reinspected, and a new record of tests/inspections is recorded and posted.

3.1.3.7 Calibrate or bump test per manufacturer instructions, Competent Person test equipment before each shift's use. Retain records for a minimum of three months after the completion of the availability and provide copies to the SUPERVISOR upon request.

3.1.3.8 Allow Navy civilian and military personnel to enter under the certificate or test / inspection record for inspection purposes.

3.1.4 Tank cleaning personnel must be trained annually on safety practices to include a discussion of safety information identified in Subparts A, B, and Section 1915.152 of Subpart I of 2.2.

3.1.5 Maintain a current roster of the names of the Shipyard/Plant Rescue Team Members, along with contractor certification that training requirements of Subpart B of 2.2 have been accomplished and are current for each Rescue Team Member, or documentation of arrangements made for an outside rescue team to respond promptly to a request for rescue service in a contractor facility. Submit one legible copy, in approved transferrable media, of the specific documents when requested by the SUPERVISOR.

3.1.5.1 At a naval facility, the Navy will respond.

3.1.6 Spaces that are determined to contain Immediately Dangerous to Life or Health (IDLH) atmospheres must never be entered except for emergency rescue or for short duration for installation of ventilation equipment in accordance with 2.2 and 2.3. When entering IDLH spaces for the purpose of installing ventilation, notify the SUPERVISOR prior to entry. Notifications of rescue must be made as soon as management becomes aware of such an event.

3.1.7 Confirm that all personnel have exited the space prior to closure of tanks, voids, and cofferdams. Designate one person to account for all personnel who may have entered the space.

#### 4. NOTES:

4.1 In addition to CHT and MOGAS tanks, Hydrogen sulfide (H<sub>2</sub>S) may be found in AFFF, seawater, and firemain systems.

4.2 Booklet of General Plans and Tank Sounding Tables are available for review at the office of the SUPERVISOR.

4.3 A "quick disconnect" is a coupling or connecting device/system designed to permit easy and immediate separation of lines without the use of tools and to ensure the contents do not escape.

4.4 Paragraph 3.1.3.7 does not alter the respective responsibilities and liabilities of the government and contractor.

4.5 The Fire Safety Council (FSC) must concur on mitigation actions. FSC must ensure a means of access/egress is maintained via the other required brow(s)/gangway(s).

NAVSEA  
STANDARD ITEM

**FY-24 CH-1**

**ITEM NO: 009-08**  
**DATE: XX FEB 2023**  
**CATEGORY: I**

1. SCOPE:

1.1 Title: Shipboard Fire Protection and Fire Prevention; accomplish

2. REFERENCES:

2.1 Standard Items

2.2 NFPA Standard 312, Standard for Fire Protection of Vessels During Construction, Conversion, Repair, and Lay-up

2.3 NFPA Standard 1962, Standard for the Care, Use, and Service Testing of Fire Hose Including Couplings and Nozzles

2.4 29 CFR Part 1915, Occupational Safety and Health Standards for Shipyard Employment

2.5 NFPA Standard 14, Standard for Installation of Standpipe and Hose Systems

2.6 NFPA Standard 1961, Standard on Fire Hose

2.7 NFPA Standard 701, Standard Methods of Fire Tests for Flame Propagation of Textiles and Films

2.8 46 CFR 164.009, Noncombustible Materials for Merchant Vessels

2.9 NFPA Standard 10, Standard for Portable Fire Extinguishers

2.10 NAVSEA OP-4, Ammunition and Explosives Safety Afloat

2.11 Underwriter Laboratories (UL) Standard 199, Automatic Sprinklers for Fire-Protection Service

3. REQUIREMENTS:

3.1 Plan and execute all work to minimize the use of temporary firefighting systems. When the scope of work allows, the ship's firemain system must provide the ship's firefighting capability.

3.1.1 If the ship's fire main system is unable to meet the requirements listed below, a temporary firemain system must be provided or a shore firefighting supply must be connected to fulfill firemain system requirements.

3.1.1.1 Installed ship's fire main must maintain sufficient fire pumps to supply daily system cooling and flushing (i.e., auxiliary) loads plus the fire protection water supply requirements contained in Attachment A.

3.1.1.2 Installed available ship's fire pumps must be physically located in different spaces. For ships requiring more than four operational pumps, up to 25 percent may be collocated.

3.1.1.3 Fire pumps must be powered from different switchboards or have operable automatic or manual bus transfers.

3.1.2 Firemain system repairs or modifications that reduce the coverage or damage control capability of the ship's firemain must be coordinated through the use of jumpers and/or temporary fire hose manifold stations in affected areas to restore firefighting capabilities.

3.1.3 Use of temporary firefighting systems must be approved by the SUPERVISOR.

3.2 Provide fire protection in accordance with 2.2 through 2.6.

3.3 Establish, document, implement, and maintain a Shipboard Temporary Fire Protection Plan when temporary fire protection is needed. The plan must include, at a minimum, the following elements:

3.3.1 Temporary firefighting and dewatering equipment inventory

3.3.2 Identification of which hoses/pipes are charged/not charged

3.3.3 Diagram of temporary firemain system, to include the following elements:

3.3.3.1 Diameter, length, and connection path of each distribution hose/pipe (See Note 4.3)

3.3.3.2 Location of each temporary fire hose manifold station.

3.3.3.3 Connection locations to shore side water supply.

3.3.3.4 Coverage for all spaces where ship's firemain is inoperative.

3.4 Submit one legible copy, in hard copy or approved transferrable media, of the initial Shipboard Temporary Fire Protection Plan to the SUPERVISOR for approval and posting no later than 10 days prior to placing any section of the ship's firemain out of service.

3.4.1 Submit one legible copy, in hard copy or approved transferrable media, of an updated Shipboard Temporary Fire Protection Plan prior to any modification to the plan after initial approval.

3.5 Provide information on the operation and use of the Temporary Firemain and the Shipboard Temporary Fire Protection Plan at least one day prior to securing ship's firemain and no later than one day prior to entering dry dock, graving dock, or marine railway.

3.6 Provide temporary fire protection equipment as follows:

3.6.1 Each fire hose must be:

3.6.1.1 Manufactured with National Hose/National Pipe Straight Hose (NH/NPSH) fittings (NH for 2 and one-half inch and larger hoses, and NPSH for one and one-half inch couplings to ensure compatibility with shipboard equipment).

3.6.1.2 Inspected and service-tested in accordance with 2.3 within 90 days prior to being placed in service for the first time and annually thereafter.

3.6.1.3 Cotton or synthetic double jacketed manufactured to the requirements of 2.6 or in accordance with MIL-H-24606B.

3.6.1.4 Each Temporary and Permanent hose or hose reel subject to damage (i.e. painting, hydro/sand blasting, and hot work) must be protected by an enclosure or covering. The enclosure or covering must be fire retardant, red, and must not significantly restrict access to the hose or hose reel for firefighting. The use of hook and loop fasteners and doors are acceptable.

3.6.2 Each fire hose nozzle must be:

3.6.2.1 One and one half inch combination straight stream and spray pattern nozzles, conforming to MIL-N-24408, rated for 125 gallons per minute (GPM) at 100 pounds per square inch (PSI).

3.6.2.2 Pre-connected to the end of each handline hose and maintained operational. (See Note 4.4)

3.6.3 Each temporary fire hose manifold station must:

3.6.3.1 Be provided in sufficient numbers such that all parts of the ship, including the interior of temporary structures, can be reached from at least 2 each, 100 foot lengths of one and three-quarters inch hand line hoses, with no allowance for stream reach.



3.6.3.2 Have, at a minimum, three handline outlets, each individually valved from each temporary fire hose manifold station. Each handline outlet must be one and one half-inch NPSH thread.

3.6.3.3 Have distribution hoses of sufficient size to meet a minimum of 95 GPM and 60 PSI residual nozzle pressure at the end of each one and three-quarters inch handline hose.

3.6.3.4 Have 2 each, 100 foot lengths of one and three-quarters inch handline hose manufactured with one and one-half inch NPSH couplings pre-connected to temporary fire hose manifold station valve outlets and faked on racks nearby.

3.6.3.5 Have pressure gauges installed with a 0 – 250 (plus or minus 50) PSI range.

3.6.3.6 Have a 0 – 250 (plus or minus 50) PSI range calibrated gauge installed on the hydraulically most remote temporary fire hose manifold station.(See Note 4.2).

3.6.3.7 Have operating instructions posted on each temporary manifold station with sources of water identified. Instructions must endure the repair process, stay attached, and be legible the entire time the station is on board.

3.6.4 Primary fire pump(s) must:

3.6.4.1 Have functioning auto start capability.

3.6.4.2 Provide GPM flow specified in Attachment A uninterrupted at a minimum of 150 PSI measured at the most remote shore side outlet providing firemain water to the ship.

3.6.4.3 Maintain constant pressure automatically without manually manipulating valves.

3.6.5 Back-up fire pump(s) must:

3.6.5.1 Be equivalent to primary fire pump(s), powered from a source(s) different than that powering the primary fire pump(s), and be pre-installed in the temporary fire protection system.

3.6.5.2 Be physically separated from the primary fire pump(s) and other back-up fire pump(s) in such a way that damage to or loss of access to fire pump(s) will not result in loss of firefighting water pressure or damage to or loss of access to other fire pump(s).

3.6.5.3 Have an operating pressure staggered from the primary fire pump(s) to minimize pump cycling (i.e. if the primary fire pump station starts at 140 psi to restore the system to 150 psi then the back-up fire pump station should be set to start at 130 psi).

3.6.6 Ensure when ship's firemain system cannot be used, portable fire pump(s) capable of providing a total of 500 GPM at 100 PSI must be on board the ship during berth shifts, transits to and from Naval facilities, dockings, undocking's. The pump must be connected to the ship's firemain system or the temporary firemain system prior to ship movement.

3.6.7 Ensure all engine driven equipment providing emergency services (firefighting water, power, and lighting) are equipped with a functioning audible low fuel level alarm capable of producing a continuous 110dBA (plus 0 or minus 25 decibel) signal.

3.6.8 When connection of the shore supply to the ship's Firemain Shore Connection fitting is not possible, ensure a tri-gate hose connection compatible with the ship's portable fire pumps is used to connect to the ship's fire plugs, to permit ship's firemain to remain in service while also acting as shore firemain connection.

3.6.9 Provide and install distribution hoses connected to the ship's permanent firemain or temporary firemain in sufficient number to deliver the fire protection capacity specified in Attachment A. This must be determined by dividing the water supply capacity from Attachment A (plus cooling and flushing loads) by the hose line capacity for the chosen distribution hose/pipe diameter. (See Note 4.1 for example).

3.6.9.1 The number of hoses connected to the ship from the shore must not be reduced when the ship's firemain becomes operational unless the permanently installed pumping capacity of the ship can meet the entire fire protection water supply requirement of Attachment A plus cooling and flushing loads.

3.6.10 Unpressurized 2 and one-half inch drop lines, supplied from a temporary hose manifold station, with a 2 and one-half inch NH by one and one-half inch NPSH by one and one-half inch NPSH hose fittings may be utilized to provide coverage to the lowermost compartments (tanks and voids) that are inaccessible with a 100 feet of handline hose, approved by the SUPERVISOR.

3.6.11 Equip temporary firemain systems with a minimum of 2 isolation valves from shore side supply prior to entry to the temporary firemain system. Place additional isolation valves in the remainder of the temporary firemain system so that the maximum distance between any 2 adjoining valves does not exceed 200 feet.

3.6.12 Provide Fire Department Connections (FDC) at the temporary firemain manifold located on the pier.

3.6.12.1 Consult with local Fire and Emergency Services (F&ES) provider to determine the type of fitting and threads required for temporary pier connections. Each temporary pier fire connection must at a minimum, consist of two 2½ inch or one 4 inch or larger connection.

3.6.12.2 For each pier connection install a UL312 listed check valve in line with each pier connection.

3.6.12.3 Post a diagram at each temporary pier fire connection that indicates which portion of the temporary firemain are served.

3.6.13 Where drydocked ships or ships under construction are constructed of combustible hull materials such as composites and wood, materials subject to melting such as aluminum, or equipped with combustible external hull/structure treatments such as Special Hull Treatment (SHT), Radar Absorbent Material (RAM), or Passive Countermeasure System (PCMS), each fire hose station must be provided such that each area of the hull/structure are reachable by 2 separate fire hose stations rigged with 100 feet of hose.

3.6.14 The ship's permanently installed AFFF system must be maintained in an operational condition during the availability, impairment to the permanently installed AFFF system or where flammable or combustible materials are temporarily stored or maintained without permanent AFFF system installed must have a mitigation plan approved by the SUPERVISOR.

3.7 Provide emergency fire protection equipment as follows:

3.7.1 Install a temporary fire alarm system on the quarterdeck configured to send a signal directly to the cognizant fire department, shipyard/Naval facility fire department, or a continuously manned location within the shipyard/Naval facility where trained personnel can take immediate action to transmit an alarm.

3.7.1.1 Each temporary fire alarm device placed aboard ship must be a fire alarm pull box, non-dial telephone, and annunciator panel, or as approved by the SUPERVISOR.

3.7.1.2 Provide a telephone on the QD, to the extent practicable, any time contractor work or location of the vessel (shipyard, Naval or contractors facility) affects the ship's casualty reporting system (ship's telephone).

3.7.1.3 Conspicuously post the emergency reporting procedures at the quarterdeck.

3.7.1.4 Test the temporary fire alarm system daily. Repair or replace defective or inoperative equipment immediately. Submit one legible copy, in hard copy or approved transferrable media, of the test report for the temporary fire alarm system, when requested by the SUPERVISOR.

3.7.2 Provide dewatering equipment to include a sufficient number of pumps capable of providing 100 GPM minimum each and a total dewatering capability equal to at least one-half of the supply GPM specified in Attachment A.

3.8 Develop and implement a written Fire Safety and Emergency Fire Response Plan in accordance with 2.4. In addition to the requirements of 2.4, the plan must identify:

3.8.1 Each integrated fire protection system in effect during the performance of the maintenance availability.

3.8.2 Each fire prevention program used, along with the types and frequency of tests of equipment and devices.

3.8.3 Details of all communication links (telephones, drop boxes, alarms, horns) location, testing interval, and interface with shore side response systems.

3.8.4 Each normal and emergency source of electric power, firefighting water, lighting, testing interval, and interface with shore side response systems.

3.8.5 Each location of all normal and emergency backup support equipment to be used in support when combating a fire, and the equipment's testing cycle.

3.8.6 Each organization to be used, designation of responsibility for all shifts, training, anticipated response times, and interface with shore side response units.

3.8.7 Ensure general procedures for directing contractor employees on fire reporting, fire responses, firefighting actions, personnel accountability, and prolonged firefighting responsibilities.

3.8.8 Provision for portable communication devices for contractor use during firefighting operations between site, fire, and contractor's/shipyard's operations center.

3.8.9 Submit one legible copy, in hard copy or approved transferrable media of the Fire Safety and Emergency Fire Response Plan to the SUPERVISOR no later than 10 days prior to commencement of work.

3.8.9.1 Submit one legible copy, in hard copy or approved transferrable media, of an updated Fire Safety and Emergency Fire Response Plan prior to any modification to the plan after initial approval.

3.9 Review the Fire Safety and Emergency Fire Response plan in accordance with 2.4 with contractor employees and subcontractors.

3.10 Ensure access to temporary and Ship's Force firefighting equipment is not obstructed or restricted.

3.11 Provide fire reporting devices in Dry dock, graving dock, or marine railway as follows:

3.11.1 Fire reporting devices must be clearly identified and located at each manifold station and each exit serving the dry dock, graving dock, or marine railway.

3.11.2 Fire reporting device separation must not exceed 200 feet horizontally along the dry dock, graving dock wall, or marine railway or 100 feet from either end of the dry dock, graving dock, or marine railway.

3.11.3 Modifications to locations of fire reporting devices for ships docked side by side, must be approved by the SUPERVISOR.

3.12 Provide water for firefighting to the ship through sufficiently sized hoses or pipes to carry capacities specified by Attachment A. These requirements must be in addition to water required for flushing and cooling.

3.12.1 Maintain a minimum of 100 PSI residual and static pressure uninterrupted for the entire availability and during testing, measured at each temporary fire hose manifold station.

3.13 Locate each temporary fire distribution hose and each fire hose manifold station to minimize exposure to areas of the ship where flooding due to a ruptured hose would cause damage.

3.14 Conduct an orientation brief to Ship's Force no later than 5 days of the availability start to include the following:

3.14.1 Procedures to rapidly secure temporary systems (e.g., air, electrical power, and ventilation) under Ship's Force control.

3.14.1.1 Train Ship's Force personnel on the procedures to operate temporary firefighting systems, if installed. Provide written operating procedures/instructions to Ship's Force on each type of firefighting system. Provide information and physical training aids for all versions of quick disconnect fittings used in conjunction with temporary services.

3.14.2 Procedures to operate temporary firefighting equipment.

(I)(G) "TEMPORARY FIREMAIN OPERATIONAL TEST"

3.15 Conduct an operational test of both shore side supply and shipboard distribution of firefighting water through the temporary firemain system prior to taking down ships firemain. 3.15.1 and 3.15.2 must be tested concurrent with acceptance criteria met simultaneously.

3.15.1 Discharge firefighting water from 4 each one and three-quarters inch handline hoses from the two most hydraulically remote temporary fire hose manifold stations on the ship that share the same distribution hose (four nozzles total). Discharge firefighting water from each hose simultaneously for 60 seconds prior to measurement start in order to obtain steady state flow conditions. Once at steady state, test firefighting water flow for a minimum of 60 seconds. Measure and record flowrate and residual nozzle pressure at each nozzle by in-line flow meter and calibrated nozzle pressure gauge. The elevation of each nozzle tested must be equal to or greater than the elevation of the temporary fire hose manifold station providing water to that nozzle. Accept/Reject Criteria: Temporary pumps must automatically start. Maintain a

minimum of 95 GPM and a minimum of 60 PSI residual pressure while flowing simultaneously at each nozzle for a minimum of 60 seconds. Pressure and flowrate must be constant, maximum nozzle pressure variation allowed during 60 seconds is plus 25 or minus 0 PSI.

3.15.1.1 When nozzle(s) cannot be tested at the same or higher elevation as the temporary fire hose manifold station(s), add 4.5 PSI to residual nozzle pressure acceptance criteria per 10 foot drop in elevation from the station(s).

3.15.2 Measure and record residual pressure at the shore side supply outlet(s) providing water to those temporary fire hose manifold stations tested in 3.15.1 while simultaneously discharging the 4 nozzles tested in 3.15.1. Accept/Reject Criteria: Maintain a minimum of 150 PSI residual pressure at the shore side supply outlet(s).

3.15.3 Accomplish a retest of 3.15.1 and 3.15.2 if the system is modified after initial test and the criteria of either 3.15.3.1 or 3.15.3.2 are met.

3.15.3.1 After any temporary firemain system modification, where the previously tested hydraulically most remote stations are no longer the hydraulically most remote.

3.15.3.2 After any temporary firemain system modification, where the available residual pressure at the most hydraulically remote stations is reduced.

(V) "TEMPORARY FIREMAIN OPERATIONAL TEST"

3.16 Conduct an operational test of temporary firemain discharge water every 60 days from the most hydraulically remote temporary fire hose manifold station to verify valves are not secured and/or obstructions in the piping system are not present. Verify that all control valves in the temporary firemain system are in the intended open/closed position. Accept/Reject Criteria: Maintain a minimum of 95 GPM and a minimum of 60 PSI residual pressure while flowing one nozzle for a minimum of 30 seconds.

(I)(G) "PERIODIC SHORE SIDE WATER SUPPLY VALIDATION"

3.17 Conduct validation of shore side water supply flow and pressure prior to availability start date, each time the vessel shifts berths, and annually thereafter should the contract extend beyond one year. Measure and record flow and residual pressure using a calibrated in-line flow meter and calibrated pressure gauge. Accept/Reject Criteria: Minimum water supply specified in Attachment A plus flushing and cooling loads is available at the shore side firemain supply outlet(s) and with a minimum of 150 PSI residual pressure.

3.18 Provide a recirculation capability where weather and flow conditions are such that freezing may occur. Freeze protection equipment must be functional when temperatures drop below 40 degrees F.

3.19 Use of aluminum piping in a temporary saltwater firemain system is prohibited.

3.20 Provide a representative, whose purpose is to coordinate and be responsible for the management of all project temporary services, including services provided by other maintenance activities.

3.21 The following applies to routing of temporary services through installed ship hull openings, both exterior and interior, designed for personnel ingress and egress:

3.21.1 Doorways/Hatches: Temporary services must be routed within the topmost area of the opening, such that the unobstructed opening of any doorway/hatch with services run must be at least fifty (50) inches high and twenty-six (26) inches wide.

3.21.2 Vertical Ladders: Temporary services must be routed to allow safe access. Route services so that personnel may transit the hatch. Services must not be routed within four (4) inches on either side of the ladder. Services routed behind the ladder must not interfere with safe access to the ladders and rungs.

3.22 Submit one legible copy, in hard copy or approved transferrable media, of a consolidated drawing in the format of a damage control diagram, depicting all services entering the ship to the SUPERVISOR within two days of services being routed onboard the ship.

3.22.1 The drawings must be conspicuously posted at the quarterdeck and damage control central for use by emergency responders. The drawing must include the issue date clearly legible on each page. The drawing must be updated weekly, or immediately to reflect significant changes, and must be suitable for use by emergency responders for isolation of services during an emergency.

3.22.2 At a minimum, the drawing must include:

3.22.2.1 Type and description of service.

3.22.2.2 Shore side shut-off points.

3.22.2.3 Route of service through the ship.

3.22.2.4 Location of quick disconnect fittings.

3.22.2.5 Identification of critical temporary services and any cautions for critical services.

3.22.2.6 Status of hull openings and access cuts and identification and location of closure materials.

3.22.2.7 De-watering capabilities.

3.22.2.8 Designated fire zone boundaries.

3.22.2.9 Critical temporary services and their shore side shut-off points must be highlighted.

3.23 Install quick disconnect fittings (QDF) within 6 feet of hull penetrations used for personnel access to facilitate the deployment of smoke control curtains. Where it is necessary to support a service between a QDF and the designated boundary or hull penetration, the type of support must not prevent rapid clearing of services from the opening.

3.23.1 For hull openings used for services only, a QDF is not required, provided the opening is fitted with an air and smoke control curtain that remains in place around the services.

3.23.1.1 Curtains must be made of fire retardant fabric in accordance with 2.7.

3.24 Temporary enclosures erected around hull access openings must be constructed with openings and removable covers to accommodate standard smoke control ventilation fans (e.g., damage control box fans). If the enclosure is constructed with ventilation fans installed, the fans must be equipped with reverse air flow capability.

3.25 Ensure that adequate protection is provided during installation, operation, and removal of temporary services. For fluid systems, spray protection must be installed at each mechanical joint of a temporary system that is inside of the hull of the vessel, in the vicinity of shore power or electrical equipment, or in the vicinity of hull openings to prevent fluids other than air spray on ship's equipment. Spray protection must consist of adequate see through sheeting (minimum 5 mils thickness) around each joint secured by several wraps of tape allowing view of the component as much as possible. Anti-chafing protection must be installed around services in particular areas (i.e., hatches, high traffic areas, vicinity of sharp objects) where there is a high risk of damage.

3.26 Provide a plan for protecting permanently installed fire detection devices to the SUPERVISOR for approval prior to commencing work that has the potential to damage or render fire detection devices nonresponsive.

3.27 The ship's permanently-installed fire detection system must be maintained in an operational condition during the availability, impairment to the permanent-installed fire detection system must be approved by the SUPERVISOR.

3.28 Use metal canister vacuum cleaners aboard the ship, except those used for regulated and controlled radiological and hazardous waste or hazardous material.

3.28.1 Vacuum cleaners must be emptied of all debris at the end of each shift at a minimum, on a daily basis.

3.28.2 Permanently and legibly mark each vacuum cleaner with a company name or unique identifier.



3.29 Plastic trash cans are prohibited for trash collection onboard in spaces where industrial work is being performed. Plastic trash bags may be used onboard as a liner for metal trash cans.

3.30 Store each plastic bodied tool in metal tool boxes or remove from the ship at the end of each shift. Equipment that must remain in service after working hours (e.g., temporary lighting, monitoring devices, etc.) is exempt from this requirement.

3.30.1 Requirements of paragraph 3.31, do not apply to currently regulated and each controlled radiological containment, nor does it supersede any requirements of the Naval Nuclear Propulsion Program.

3.31 Temporary lights must have 3-conductor cable, guard or shield, hook, and lamp holder. Exposed non-current-carrying metal parts of the fixture must be grounded either through a third wire in the cable containing the current conductors, or through a separate wire that is grounded at the fixture's voltage source.

3.31.1 Temporary lighting fixtures must not be used to power portable electric tools.

3.31.2 Maintain temporary lights in a safe condition. Splices must not be permitted in magazine and ammunition handling spaces.

3.32 Temporary services must be suspended using non-combustible high temperature devices, brackets, or material that meets test requirements of 2.8. Plastic tie wraps, string, rope, or other combustible material must not be used.

3.33 Temporary services must be positively identified with durable unique markings that include maintenance activity name, service type, location, and shore side shut-off points. Tags must be located (at a minimum) at the source, point of entry aboard ship, at each connection point (including quick disconnects), and termination point. Vital services must be designated by the SUPERVISOR.

3.34 Rigging of temporary services, such as but not limited to hoses, electrical lines, welding leads, and temporary lights must be kept clear of the decks utilizing temporary support trees or ship's structural members, such as beams, braces, and welded brackets and be arranged to minimize tripping and other safety hazards and to allow free access through doors, hatches, and passageways.

3.34.1 Temporary service lines must be routed to allow emergency access and egress to all areas of the ship and must not impede damage control and watchstander performance of duties. Where appropriate, run temporary services outboard to keep passageways clear.

3.34.2 Remove temporary services from the ship when no longer in use.

3.34.3 Evaluate temporary services during the daily safety, fire prevention, and housekeeping inspection, made jointly with the SUPERVISOR and Ship's Force. Discrepancies must be promptly corrected.

3.35 Shipboard temporary ventilation systems used for exhausting toxic contaminants and/or flammable vapors must be constructed so that ducting within confined and enclosed spaces is under negative pressure.

3.35.1 Use fire retardant ventilation ducting. Proper documentation of fire retardancy must be available for review upon request of the SUPERVISOR.

3.36 Crimping or pinching of fuel gas/oxygen/compressed gas hoses, air hoses, or hoses carrying hazardous/toxic/flammable materials is prohibited. All hoses must be disconnected at the manufacturer's fittings. Prior to disconnecting hoses from equipment/tool, pressure must be released by disconnecting the hose from the source, e.g., manifold or gas cylinder.

3.37 "Screw type" hose clamps are prohibited on any pressurized hose (e.g., compressed gas and air hoses).

3.38 Each inert gas/oxygen depleting (OD), fuel gas and oxygen hose run must be positively identified with durable unique markings that include maintenance activity name, service type, location, and shore side shut-off points. Tags must be located (at a minimum) at the source, point of entry aboard ship, at each connection point (including quick disconnects), and termination point.

3.38.1 Unattended hose lines or torches are prohibited in confined spaces.

3.38.2 All hose lines must be disconnected at the supply manifold at the end of each shift.

3.38.3 All disconnected hose lines must be rolled back to the supply manifold or to open air to disconnect the torch; or extended fuel gas and oxygen hose lines must not be reconnected at the supply manifold unless the lines were given a positive means of identification when they were first connected and the lines are tested using a drop test to ensure the integrity of fuel gas and oxygen burning system. Alternate procedures must be approved by the SUPERVISOR.

3.38.4 Upon completion of system hook-up, accomplish a pressure drop test to include the torch, hoses, and gauges.

3.38.5 Apply pressure to the system. Back off pressure by turning off the valve supplying gases to the system. If the pressure on the gauge drops, a leak in the system exists. If the pressure on the gauge does not drop, the system is tight.

3.38.6 After applying pressure, wait 2 minutes to ensure pressure does not drop.

3.38.7 The use of gas hose splitters is prohibited.

3.39 Locate oxygen, acetylene, fuel gas, toxic, refrigerant, air conditioning gases, oxygen depleting (OD) gas supply systems off the ship. Manifolds connected to pierside supply systems may be placed on board ships as long as they are located on a weather deck and equipped with a shutoff valve located on the pier. The pierside shutoff valve must be in addition to the shutoff valve at the inlet to each portable outlet header required by 2.2.

3.39.1 Oxygen, acetylene, fuel gas, toxic, and OD gas supply systems must be stored to prevent collisions by trucks, forklifts, falling objects, etc.

3.39.2 Liquid oxygen (LOX) tanks must be staged in designated locations on the quay wall/pier to be determined by the Fire Safety Council (FSC) via the SUPERVISOR.

3.39.3 When gas cylinders are in use on board ship, they must be located on the weather decks or in a location determined by the Fire Safety Council (FSC) via the SUPERVISOR and must be secured in cylinder racks, and in an upright position. The number of in-use cylinders must be limited to those which are required for work in progress and which have pressure regulators connected to the cylinder valves. On-board reserve gas cylinders must not exceed one-half the number of in-use cylinders and must be located in a remote area of the weather decks or in a location determined by the FSC via the SUPERVISOR. Reserve acetylene cylinders must be secured in an upright position.

3.39.4 When not in use, gas cylinders and manifolds on board must have valves closed, lines disconnected, protective cover (cap) in place, and must be secured. Acetylene cylinders must be secured in cylinder racks and in an upright position.

3.40 The ship's permanently-installed general announcing system will be maintained in an operational condition during the availability. Any work that would impair the permanently-installed general announcing system must have a mitigation plan approved by the SUPERVISOR.

3.40.1 Install a temporary general announcing system which can be heard or seen in each space that is not normally manned and the ship's general announcing system cannot be heard, such as occupied tanks and voids, including tanks entered through hull cut access when in dry dock. The temporary general announcing system must be approved by the SUPERVISOR prior to the start of work.

3.40.2 Install an audible and visible system to warn personnel to evacuate the ship. The audible phase must consist of a klaxon horn, siren, or other device and must be clearly distinct from the fire and stop hot work alarms. Sounding of the evacuation alarm must be accompanied by the flashing of lights on all alarm box stations. Both the audible and visible signal must be actuated from the central CASCON Station and/or DCC/Quarterdeck. The evacuation alarm system must be approved by the SUPERVISOR. The ship's temporary or permanent announcing system may be used for

evacuation ship alarm and will announce the emergency. To achieve separate fire, stop hot work, and evacuate ship alarms, the ships announcing system must be used to announce the nature of the emergency in conjunction with the alarm actuation.

3.40.3 Install casualty reporting non-dial red telephones with an indicator light that report to the Ship's Quarter Deck or a system approved by the SUPERVISOR when the Shipboard Casualty Reporting System is nonoperational. Install telephones in each fire zone at least every 100 feet of ship's length on decks/platforms, placed on alternating sides of the deck/platform and located at a junction with athwartship passageways. Install a telephone on each level and each fire zone of the ship's superstructure, such that a telephone is within 100 feet of any part of the level. Install telephones in each space of decks/platforms below the Damage Control or Main Deck less than 100 feet of ship's length, within ten feet of all exit ladders. Install a telephone within ten feet of the exit to each tank open for maintenance. Label each phone with space location.

***3.41 Provide a representative whose function is to coordinate hot work notification and execution, known as the Hot Work Coordinator, for each Repair Activity (RA) work performed during the contract performance period.***

***3.41.1 Hot Work Coordinator must:***

***3.41.1.1 Receive, review, and coordinate each hot work authorization form submitted by each RA.***

***3.41.1.2 Complete Attachment C for each approved hot work authorization form and sign after verifying with Hot Work Supervisor that hot work is ready to commence and after hot work has ended. Each signature affirms requested hot work authorization form will be worked each shift and that the hot work has ended.***

***3.41.1.3 Meet daily, when hot work is scheduled with each designated representative from each RA, the Commanding Officer's designated representative, and the SUPERVISOR to eliminate each hot work conflict, and to advise the SUPERVISOR of each hot work problem that could impact the RA's or any ship's work operation.***

***3.41.1.4 Participate in each Fire Safety Council (FSC) meeting when needed to support adjudicating each request for deviation.***

***3.41.1.5 Ensure that each RA submits a properly filled out hot work authorization form.***

***3.41.1.6 Submit each hot work authorization form to the Commanding Officer's designated representative responsible for maintaining Attachment D at a location agreed upon by the FSC.***

**3.41.1.7** *Ensure each hot work authorization form revision submitted by the cognizant RA is processed prior to proceeding with the work necessitating the revision to the hot work authorization form.*

**3.41.1.8** *Prioritize allocation of hot work authorization forms each shift based on the integrated production schedule.*

**3.42** *Provide notice for each job or separate area of hot work aboard ship using a hot work authorization form.*

**3.42.1** *Submit one legible hard copy or approved transferrable media, to the Hot Work Coordinator for submission to ships force by 1400 the day prior for high confidence hot work.*

**3.42.2** *A smaller number of hot work authorization forms may be submitted after the arrival of the first shift on the day of execution. This number must not exceed 20 percent of the total hot work submitted for execution that day.*

**3.42.3** *Hot work authorization form provided to the Hot Work Coordinator must, at a minimum, include a serial number, a description of the work to be done, specific location compartment number, and each compartment adjacent to each deck, bulkhead, and similar structure upon which hot work is to be accomplished and the time hot work will commence.*

**3.42.4** *Notify Hot Work Coordinator if a condition changes and a hot work authorization form will not be performed, needs to be modified, or substituted with another hot work authorization form.*

**3.42.5** *The amount of hot work authorization forms submitted must not exceed each parameter identified in Attachment D.*

**3.42.6** *Submit one legible copy, in approved transferable media, of each request for deviation to the SUPERVISOR.*

**3.42.6.1** *Each request submitted must include rationale for the deviation, the quantity of hot work authorization forms exceeding the thresholds identified in Attachment D, and duration of deviation.*

**3.43** *Inspect and authorize each hot work area aboard ship.*

**3.43.1** *Post the submitted hot work authorization form conspicuously at the entrance to each compartment or area where hot work is being performed. Provide a copy of each hot work authorization form to the SUPERVISOR upon request.*

**3.43.2** *Hot work authorization form must include, in addition to each requirement listed in 3.42.3, current gas-free status of the area, any presence of combustible material within 35 feet in any direction of the operation, or further if affected by the operation, and if any combustible material is present, each action that must be*

*taken to protect the material from hot work, provision and assignment of each fire watch, and affirmation that the condition at the work site includes ventilation, temporary lighting, accesses, and permits each fire watch to have a clear view of and immediate access to each affected area.*

*3.43.3 Hot work authorization form must affirm each fully-charged fire extinguisher suitable to the type and location of hot work being performed in accordance with 2.9 is available at the work site. Inspect each area 30 minutes after completion of hot work unless the contractor's Hot Work Supervisor surveys each affected work area and determines that there is no further fire hazard.*

*3.43.4 Hot work authorization form must be signed by a Hot Work Supervisor specifically designated as responsible for the execution of hot work for each shift where hot work is being accomplished after the Hot Work Supervisor has physically verified the exact location and extent of hot work with each Hot Work Operator.*

*3.43.5 Hot work authorization form is effective for 24 hours unless a shorter period is specified in the contract or the gas-free status of the work area or system requires work stoppage.*

*3.43.6 A new hot work authorization form is required if work is interrupted due to loss of gas free status.*

**3.44** *Submit a weekly hot work report in approved transferable media that will be reviewed during the weekly production meeting. The report must include:*

*3.44.1 Daily recap of the number of hot work authorization forms submitted, number of hot work authorization forms executed, percent of hot work authorization forms executed compared to submitted, and reason (i.e. excess form submitted, lack of material/equipment or personnel, weather, reprioritization of personnel, change in gas-free status) for each hot work authorization form not executed.*

*3.44.2 Two-week forecast of planned hot work to include the date, shift, work item number, and location of hot work.*

**3.45** Provide trained fire watches, at all affected areas where hot work is being accomplished. Provide fire extinguishing equipment as described in 2.2 and 2.4.

3.45.1 The program utilized to train fire watches must be in accordance with the requirements of 2.2, and include steps to be taken by the fire watch and hot work operator prior to accomplishment of hot work, proper selection and use of fire extinguishing equipment and other safety equipment, relationship between the fire watch and hot work operator, proper fire reporting procedures and other sounding of fire alarms, and reporting of fires to the ship's Quarterdeck. A means of communicating between all fire

watches and their corresponding hot workers must be provided. This training must include theory and practical (hands-on) fire suppression techniques. This training must be provided to all newly assigned fire watches, with annual updates provided to personnel. Provide visible means of identifying trained fire watches, i.e., badge, sticker, vest, etc.

3.45.2 Submit one legible copy, in approved transferrable media, of the training program when requested by the SUPERVISOR.

3.45.3 Each fire watch attending worker(s) accomplishing hot work must be equipped with a fully-charged and operable fire extinguisher, have immediate access and an unobstructed view of the affected hot work area to which they are assigned and must remain at the job site for 30 minutes from the time the hot work is completed unless the contractor's Hot Work Supervisor surveys the affected work area and determines that there is no further fire hazard.

3.45.4 The fire watch must not accomplish other duties while hot work is in progress.

3.45.5 Where several workers are accomplishing hot work at one site, the fire watch must have a clear view of and immediate access to each worker accomplishing hot work.

3.45.6 No more than 4 workers must be attended by a single fire watch.

3.45.7 In cases in which hot material from hot work may involve more than one level, as in trunks, machinery spaces, and on scaffolding, a fire watch must be stationed at each level unless positive means are available to prevent the spread or fall of hot material.

3.45.8 In cases where hot work is to be accomplished on a bulkhead or deck, combustible material must be removed from the vicinity of the hot work on the opposite side of the bulkhead, overhead, or deck, and a fire watch must be posted at each location.

3.45.9 If multiple blind compartments are involved in any hot work job, fire watches must be posted simultaneously in each blind area.

3.45.10 Comply with the firefighting and fire prevention requirements of 2.X3 prior to hot work operations in or adjacent to areas containing ammunition or explosives.

3.45.11 Hot work must not be conducted during any logistics or maintenance movement of ammunition or explosives.

3.45.12 No hot work must be performed without an operational general announcing system, i.e., Ship's 1MC, or a documented communication strategy approved by the SUPERVISOR.

3.46 Use fireproof or fire-retardant covering in accordance with MIL-C-24576, such as fireproofed canvas, fire-resistant synthetic fabrics, non-combustible fabrics, metal covers in accordance with ASTM D6413, or other suitable materials, to protect ship's equipment from falling sparks or other potential sources of fire. Install coverings prior to commencing hot work and maintain throughout the hot work evolution. Fire Retardant Gel (FRG) products in accordance with CID A-A-60022 may be used in conjunction with approved fireproof or fire-retardant covering for additional fire and thermal protection. FRG products cannot be used as stand-alone fire protection. Remove FRG residue from ship's equipment in accordance with SSPC-SP 1 at the completion of hot work. Proper documentation of fire retardancy must be available for review upon request.

3.46.1 Non fire-retardant temporary wooden structures located on the pier, dry dock edge, or in the dry dock (not including dry dock blocks) must be a minimum of 35 feet from the ship to prevent spread of fire.

3.46.2 Lumber, plywood, and staging boards, except that used for pallets, must be fire retardant in accordance with Category Two, Type II, of MIL-L-19140.

3.46.3 Storage of material aboard ship must be limited to that which is required for work in progress. Materials, trailers, temporary lights, flammable liquids, fueling of vehicles, and the rigging of hoses/welding leads/temporary lights aboard the ship must comply with the following: Material, including that stowed in bins that are placed and held temporarily on hangar decks, well decks, or tank decks must not exceed 8 feet in height. A 20-foot-wide lane must be maintained the length of hangar decks to act as a fire break. Material must occupy a deck space not to exceed 25-feet by 25-feet with adjacent 6-foot-wide aisles on each side for ready hose line access.

3.46.4 Prior to bringing equipment or working material aboard ship, its crating and packing must be removed. If the equipment or material may be damaged during handling, the crating and packing must be removed immediately after the equipment or working material is brought aboard and taken ashore for disposal. A small quantity of pallets may be staged in a location determined by the Fire Safety Council (FSC) via the SUPERVISOR aboard ship for use in materials handling operations.

3.46.5 Install sprinkling systems (or other firefighting equipment approved by the supervisor) on temporary structures constructed or staged in an internal sprinklered area of the ship (e.g., hangar bay, helo hangar) onboard for the purpose of material stowage.

3.46.6 Identify sprinkler and open sprinkler pendent, upright or sidewall type. The type must be most suitable for the shape and configuration of the protected area. Pendent and upright sprinklers must have 180-degree full cone spray patterns. The sprinkling density must be 0.2 gpm/sqft and the sprinklers must be arranged to cover the entire level of the temporary structure and all contents. Follow the manufacturer's instructions for spacing of sprinklers, distance from the overhead of the protected area, and distance from



stowed material or obstructions. Place placards on the interior of the protected area and note the height that material cannot be stacked above.

3.46.7 The system must be a dry deluge type, manually operated by a quarter-turn sprinkler valve located outside and near the access to the structure. The system must be continuously charged up to the sprinkler valve, from the ship's permanent or temporary firemain, using temporary piping or a non-collapsible hose suitable for the pressure and flow. Piping downstream of the sprinkler valve must be metal. Aluminum must not be used for piping. Place a placard at the sprinkler valve identifying the protected area and providing instructions on operating the sprinkler valve. Provide freeze protection with the water supply.

3.46.8 Automatic sprinklers, with the heat responsive and activating elements removed, may be substituted for open (deluge) sprinklers.

3.46.9 CONEX boxes/MILVANS staged within the ship for material storage or other operational purposes must be of all steel exterior construction and be capable of being completely sealed closed. Each enclosure placed on board the ship must be supported at least 10 inches above the deck. Only Class A type combustibles and non-combustibles are permitted to be stored within such structures and they must remain completely sealed closed when not being physically manned. When such structures are used as manned office or operating spaces (including temporary Enclosed Operating Stations), they must be equipped with smoke detection in accordance with 2.11 and must have at a minimum, one fire extinguisher of appropriate size and class at each access. The use of kitchen appliances (microwaves, coffee makers, hot pots, etc.) and hot work within the unit is prohibited.

3.46.10 Smoke alarms, approved by Underwriter's Laboratory, must be installed in enclosures and must be audible outside the enclosures.

3.47 Install sprinkling system on each temporary structures constructed or staged onboard not for the purpose of material stowage. The sprinkling density must be 0.1 gpm/sqft and the sprinklers must be arranged to cover the entire level of the temporary structure and all contents. The system must be a wet automatic type. The system must be continuously charged up to the sprinkler, from the ship's permanent or temporary firemain. Place a placard at the sprinkler valve identifying the protected area and providing instructions on operating the sprinkler valve. Provide freeze protection with the water supply. Operation of the sprinkler system must sound an audible alarm outside the structure. Install smoke detection system inside the structure. Provide audible alarms both inside and outside the structure. Provide portable AFFF and CO2 extinguishers interior to the structure near the access.

3.47.1 The quantity of flammable and combustible liquids brought onboard must be kept to a minimum, must not exceed that necessary for one shift's use, and must not be left unattended.

3.48 Fueling of vehicles or transfer of fuel between containers must be accomplished at designated sites on weather decks or in a location determined jointly by the contractor, Ship's Force, and the SUPERVISOR. Notify ship's Officer of the Deck prior to the fueling or transfer operation. When fuel is transferred between containers, the containers must be bonded and grounded to prevent static discharge. Fueling operations must be conducted at designated sites on exposed weather decks. All fuel must be transferred aboard ship in approved safety containers. Direct fueling of vehicles aboard ship must be avoided but may be utilized during operations via an approved fuel storage tank on the weather deck (flight deck, Helo deck, or deck edge elevator) provided the following safety precautions are provided and maintained by the performing activity:

3.48.1 Fuel storage tanks must be either of double wall construction or have integral cofferdam sized to exceed tank capacity.

3.48.2 Locate fuel storage tanks in a location approved by the SUPERVISOR, open to atmosphere on an exposed weather deck and not in interior spaces where a build-up of fuel vapors would be of concern.

3.48.3 Fuel storage tanks must be inspected and verified by safety personnel to meet safety requirements.

3.48.4 Perform and document weekly inspections of the fuel storage tanks.

3.48.5 Provide 2 dry chemical fire extinguishers, each with an Underwriter's Laboratory rating of at least 60 B:C, within 20 feet of each fuel storage tank.

3.48.6 Post signs at each storage tank designating ownership and contact numbers in the event of an emergency.

3.48.7 Stage an Oil and Hazardous Substance Spill Response Kit at each fuel storage station.

3.48.8 Install metal coamings 4 inches high, tack welded and caulked to the deck, around all through-deck access openings to control flammable liquid spills. Modifications from this requirement based on location of the access openings may be approved by the FSC via the SUPERVISOR.

3.49 FRG products may be used on welding blankets, curtains or pads when performing hot work in areas with combustible materials that are not movable (such as cable ways) and to protect equipment. Remove all non-stationary combustible material within 35 feet where possible. FRG or coated blankets, curtains or pads must not be used in direct contact of the backside of welds or in close proximity to welds. FRG or coated blankets, curtains or pads must not be placed closer than the minimum required stripback distance for heat sensitive material (e.g. paint) or 6" whichever is greater. For applications where stripback is not required, FRG or coated blankets, curtains or pads must not be placed closer than 6" to a weld. FRG or coated blankets, curtains or pads must not be used in direct contact with materials to be welded that are

subject to Hydrogen Induced Cracking (HIC), are hardenable, have toughness testing requirements, are subject to elevated preheat temperatures (>60°F minimum) or interpass temperature controls, or require specific welding procedure qualification involving high and low cooling rate testing (e.g. high carbon or alloy steel, HY steel, HSLA steel, and duplex stainless steels).

3.50 Plan and execute work in such a manner that the ship's permanently installed lighting and power systems will be out of service for the minimum amount of time.

3.50.1 Install temporary lighting for ship's lighting systems that are non-operational or require additional illumination.

3.50.2 Provide 2 sources of lighting to all spaces that normally have 2 sources for ship's lighting systems that are non-operational. The lighting may be the ship's permanent and emergency lighting systems or a combination of temporary and ship's permanent lighting, provided that separate power sources are utilized for each system. The removal of lighting from spaces or compartments that could impede damage control efforts, personnel egress, and/or casualty responder access must require approval by the SUPERVISOR prior to removal.

3.50.3 Permanent or temporary lighting must meet the illumination requirements of 2.2.

3.51 Accomplish temporary access requirements as follows:

3.51.1 Temporary access cuts may be made in fire zone boundaries provided they are equipped with fume tight steel closures when installed. Boundary degradation by use of temporary access cuts or passage of service lines must be permitted only upon granting of a written waiver by the FSC via the SUPERVISOR, for a limited time.

3.51.2 Submit one legible copy, in approved transferrable media, of a record of boundary openings and their locations to the SUPERVISOR and one additional copy to the Commanding Officer's designated representative. Resubmit boundary opening data when any changes, additions, or deletions of boundary openings occur.

3.51.3 Stage fire retardant material adjacent to the ship to provide for temporary closure of access cuts, hatches, and other hull penetrations created by contractor work (e.g., access cuts and open hatches due to running of temporary services).

3.52 Ensure at least one **completely** unobstructed (*e.g. no temporary services*) access on ships designed with 3 or fewer accesses to each main and auxiliary machinery space and at least 2 **completely** unobstructed (*e.g. no temporary services*) accesses on ships designed with 4 or more accesses to each main and auxiliary machinery space.

3.52.1 Accomplish a safety, fire prevention, and housekeeping, inspection during each shift whenever work is in progress. Once each manned/regular workday, the inspection must be made jointly with the SUPERVISOR and the Commanding Officer's designated

representative. Deviation from this requirement for availabilities less than 30 days in duration must be adjudicated by the SUPERVISOR.

3.52.2 Submit one legible copy, in approved transferrable media, of request for deviation to the SUPERVISOR.

3.52.3 Submit one legible copy, in an approved transferrable media, of a written report of the discrepancies and corrective actions, using Attachment E, to the SUPERVISOR and the Commanding Officer's designated representative within 4 hours after completion of the inspection. All discrepancies, to include discrepancies corrected on the spot, must be documented and assigned responsibility for corrective action (e.g prime contractor, sub-contractor, AIT, and ship's force).

3.52.4 Provide a safety representative to accomplish the safety, fire prevention, and housekeeping, inspection who at a minimum has completed *competent person training in accordance with 009-07 of 2*. and the following OSHA Training Institute (OTI) courses or NAVSEA approved equivalents: 5410; Occupational Safety and Health Standards for Maritime Industry, 3095; Electrical Standards, 3115; Fall Protection, 521; OSHA Guide to Industrial Hygiene.

3.52.5 Submit one legible copy, in approved transferrable media, of the certificates of completion for the required courses upon request by the SUPERVISOR.

3.53 Determine fire zone boundaries as follows:

3.53.1 The FSC via SUPERVISOR must establish fire zone boundaries prior to start of production work.

3.52.2 For ships having fire zones by design, the designated bulkheads must be used as fire zones. Ships under 600 feet in length that do not have fire zones by design must have a minimum of 2 fire zone boundaries. Ships 600 feet and over in length that do not have fire zones by design must have a minimum of 3 fire zone boundaries.

3.53.3 Fire zone boundaries must be continuous through the vertical extent of the ship, from the keel up to the highest weather deck, excluding the superstructure.

3.53.4 For ships that have established fire zone boundaries that run from keel up through the superstructure, the fire zone boundaries as depicted on the ship's damage control diagrams must be observed.

3.53.5 On aircraft carriers, provide for closing of hangar division doors in case of fire in the event division doors being repaired by the contractor are mechanically inoperative. As a minimum, rig chain falls to manually close doors in the event of fire. Exceptions must be permitted only upon execution of a written waiver approved by the FSC via the SUPERVISOR.

3.53.6 Indicate each fire zone by installing a sign adjacent to each entrance. Mark each sign with international orange tape.

3.53.7 Maintain the ship's fire zone boundaries to the maximum extent practicable throughout the availability. This includes maintaining the capability of fire insulation where installed, fire-rated penetrations such as multi-cable transits (MCTs) and pipe penetrations, fume-tightness of the boundary, etc.

3.53.8 Degradation of a fire zone boundary must be approved by the SUPERVISOR. Install fire retardant material, such as fire resistant curtains/cloth, at each fire zone boundary degradation for immediate deployment by personnel when securing from work or evacuating the space.

3.53.9 Service line(s) must not be run through fire zone boundaries unless quick disconnects are installed in temporary service lines within 6 feet of the opening, door, or closure. The quick disconnects must be marked with international orange tape and be positively identified with durable unique markings that include the maintenance activity name, service type, location, and shore side shut-off points. All service line(s) must be able to be secured and pulled back within 3 minutes. Fuel gas/oxygen/compressed gas hoses, steam lines, hoses pressurized above 140 PSI, temporary general announcing/*alarm* system wiring, *temporary heat and smoke sensor system wiring*, and hoses carrying hazardous/flammable materials (as defined in Subpart P of 2.2) must not be run through fire zone boundaries. The number of temporary service lines or their size must not restrict free and easy access or closure of fire zone boundary doors.

3.53.10 Demonstrate that all service lines are able to be pulled back within 3 minutes in coordination with SUPERVISOR scheduled fire drills. The FSC via the SUPERVISOR will determine the fire zone boundary.

3.53.11 Request for deviation must be in writing to the FSC via the SUPERVISOR and must include the following; rationale for deviation, location(s) and duration of each deviation, description of services that will violate any fire zone boundary, hazards associated with services, and the hazard mitigation plan(s).

3.54 Shipboard Access (Surface Ships). On surface ships, one gangway must be located at the ship's quarterdeck. For Surface Ships less than 700 feet in length, one additional gangway must be provided. For Surface Ships 700 feet or over in length, two additional gangways must be provided. Each gangway must be located in a separate fire zone unless an alternate arrangement is approved by the FSC via the SUPERVISOR.

3.54.1 Each route of escape leading to each exit and gangway must be clearly marked and must endure an industrial work environment, stay attached, and remain legible.

3.54.2 When one of the brow/gangways designated for personnel access/egress must be secured, notify the SUPERVISOR for concurrence. (See 4.11)

3.55 Provide a clearly readable status board at the shore side access to each brow/gangway within two days of services being routed on the ship for availabilities 45 days and greater.

3.55.1 The status board(s) must have the following information:

3.55.1.1 The status of access/egress openings and must be updated as conditions change.

3.55.1.2 Space layouts and terminology in the format of a damage control diagram for the ship.

3.55.1.3 Areas where access may be limited due to routing of temporary services, work in progress and/or secured access and egress routes.

3.55.1.4 Ship plan of the day (SPOD).

3.55.1.5 Temporary service diagram (TSD).

3.56 Ensure access to temporary and Ship's Force firefighting equipment is not obstructed or restricted.

3.56.1 Ensure Ship's Force firefighting equipment is not relocated without written authorization from the SUPERVISOR. Provide a secure, Ship's Force accessible temporary storage facility for firefighting equipment that is moved from its original location.

3.57 Conduct a firefighting and fire prevention conference in conjunction with the arrival conference or no later than 5 days after start of the availability for availabilities in excess of 30 days. This conference must familiarize Ship's Force with the contractor's fire safety and fire response plan and with the procedures that will be in use by the contractor and the region/installation or municipal fire and emergency services, and familiarize all parties with the scope of work and aspects of the work or ship conditions that have significance in fire prevention and firefighting.

3.57.1 The conference must specifically address the following matters:

3.57.1.1 Fire alarm and response procedures.

3.57.1.2 Contractor firefighting capability and procedures.

3.57.1.3 Region/installation or municipal fire and emergency services firefighting capability and procedures.

3.57.1.4 Firefighting jurisdictional cognizance and incident command procedures.

3.57.1.5 Communication system for fire reporting and control or firefighting efforts.

3.57.1.6 Shipboard arrangement including access routes, availability or firefighting systems (installed and temporary), fire zone boundaries, and communication systems.

3.57.1.7 Each shipboard firefighting organization, system, drill, and equipment to include rehabilitation procedure.

3.57.1.8 Ship, space, and equipment security consideration.

3.57.1.9 Compatibility of ship, contractor, and region/installation or municipal fire and emergency services firefighting equipment.

3.57.1.10 Industrial work scope, including location of ship, and effect on firefighting systems, access, and communications.

3.57.1.11 The roles, responsibilities, and membership of the Fire Safety Council (FSC). Include the requirement to obtain permission from the FSC to perform work that affects the fire safety posture (e.g., securing the firemain, securing the 1MC, undocking, transferring fuel/lube oil) of the ship.

3.57.1.12 Hot work monitoring and confined space practices.

3.57.2 The firefighting and fire prevention conference must include a table top fire drill.

3.58 Conduct a tour of the ship with region/installation or municipal fire and emergency services personnel, the SUPERVISOR, Ship's Force, and contractor key personnel assigned specific responsibilities during fires to familiarize personnel with the ship's normal access, ship arrangement, shipboard fire prevention, and firefighting systems, equipment, and organization and anticipated condition while industrial work is in progress.

3.59 Provide a portable 300 KW diesel generator with associated cables, lugs/plugs to supply emergency power during transits to and from dry dock when ship's emergency power cannot be used.

3.60 For Navy boats and craft, all paragraphs of this standard item will apply except paragraph 3.59.

3.61 Stage dust collectors off the ship.

3.61.1 Submit each request for deviation to the FSC via the SUPERVISOR for adjudication. Deviation request must include a written risk mitigation plan.

3.62 Provide cognizant management representation to participate in reoccurring Fire Safety Council meetings.

3.62.1 Cognizant management representation must be prepared to address fire safety, work, and energy control problems, and offer a reasonable solution to each problem, which may have impact on fire safety posture during the availability.

3.62.2 The representative(s) must be authorized to make each management decision relative to each routine fire safety decision of the Fire Safety Council that, in good faith, commit the contractor.

3.63 Notify the vessels Quarterdeck and the Supervisor immediately by verbal means of each fire, which occurred, or is occurring on the vessel, dry dock where a naval vessel is docked or a pier/berth where the vessel is moored.

3.63.1 Secure and preserve the scene until released by the SUPERVISOR.

3.63.2 Submit one legible copy, in approved transferrable media, of a formal written report, Attachment F, of the incident to the SUPERVISOR within one day of each fire. Provide daily updates within one day upon request by the SUPERVISOR, until the final report is submitted.

#### 4. NOTES:

4.1 Example equation for DDG-51 Class with 200-foot hose:

Parameters for the example:

Attachment A = 1000 GPM for DDG

Sample Cooling and flushing load: 250 GPM

Attachment B = 200 GPM for 200-foot hose of 2 and one-half inch hose

$$\frac{(\text{Attachment A} + \text{Cooling and Flushing Load})}{\text{Attachment B}} = \# \text{ of hoses required}$$

$$\frac{(1000\text{gpm} + 250 \text{gpm})}{200\text{gpm}} = 6.25 \text{ hoses}$$

Requires 7 (rounded up to next whole number) 2 and one-half inch hoses to supply firefighting and cooling load.

4.2 “Hydraulically Remote” is defined as an area/location that will encounter the highest pressure loss, from both flow friction and elevation change, while encountering maximum possible flowrate.

4.3 Distribution Hose is defined any hose or pipe that transports water to the temporary hose manifold stations or ship’s firemain.

4.4 Handline Hose is defined as the hose(s) that transports water from the temporary hose manifold station to the hose fire nozzle.

4.5 Air and smoke control curtains are not intended to provide an air tight seal of the hull opening. The curtains are to ensure that emergency responders can control the flow of air and



smoke through the opening to allow for de-smoking of compartments, and minimize “chimney” effects.

4.6 A "quick disconnect" is a coupling or connecting device/system designed to permit easy and immediate separation of lines without the use of tools and to ensure the contents do not escape.

4.7 Shipboard fixed extinguishing systems such as Halon and CO2 are to be secured or isolated only at the discretion of the ship’s Commanding Officer or designated representative. Employees should be trained as required by 2.2 before entering/working in spaces with active shipboard fixed extinguishing systems.

4.8 The term “annual” means once a year, not-to-exceed 12 months.

4.9 FRG CID permanent identification number; A-A-60022. |

4.10 Fires are unintended states, processes, or instances of combustion in which fuel or other material is ignited and combined with oxygen, giving off smoke, sparks, or flame. Smoke or sparks may or may not be present. However, if unexpected smoke or sparks exist, a fire should be assumed to exist (this is especially relevant to Class 'C' fires when the smoke or sparks cease after power is secured).

4.11 The Fire Safety Council (FSC) must concur on mitigation actions. FSC must ensure a means of access/egress is maintained via the other required brow(s)/gangway(s).

ATTACHMENT A  
FIRE PROTECTION WATER SUPPLY REQUIREMENTS

<u>SHIP CLASS</u>	<u>SHIP TYPE</u>	<u>FLOW (GPM)*</u>
AD	Destroyer Tender	1,500
ADG	Degaussing Ship	500
AE	Ammunition Ship	1,500
AF	Store Ship	1,500
AFS	Combat Store Ship	1,500
AG	Miscellaneous Auxiliary Ship	1,500
AGEH	Hydrofoil Research Ship	500
AGF	Miscellaneous Flagship	2,000
AGFF	Frigate Research Ship	1,000
AGM	Missile Range Instrumentation Ship	1,500
AGMR	Major Communications Relay Ship	1,500
AGOR	Oceanographic Research Ship	500
AGP	Gunboat Support Ship	2,000
AGS	Surveying Ship	1,000
AH	Hospital Ship	1,000
AK	Cargo Ship	1,500
AKS	Store Issue Ship	1,500
AKR	Vehicle Cargo Ship	1,500
ANL	Net Laying Ship	500
AO	Oiler	1,500
AOE	Fast Combat Support Ship	1,500
AOG	Gasoline Tanker	1,000
AOR	Fleet Replenishment Oiler	1,500
AP	Transport Ship	1,000
APB	Self-propelled Barracks Ship	500
AR	Repair Ship	1,500
ARB	Battle Damage Repair Ship	500
ARC	Cable Repair and Laying Ship	1,000
ARG	Internal Combustion Engine Repair Ship	1,500
ARL	Landing Craft Repair Ship	1,000
ARS	Salvage Ship	500
ARST	Salvage Tender	1,000
ARSD	Salvage Lifting Ship	500
ARVA	Aircraft Repair Ship	1,000
ARVE	Aircraft Engine Ship	1,000
ARVH	Helicopter Tender	1,500
AS	Submarine Tender	1,500
ASR	Submarine Rescue Ship	600

ATTACHMENT A  
FIRE PROTECTION WATER SUPPLY REQUIREMENTS (Con't)

<u>SHIP CLASS</u>	<u>SHIP TYPE</u>	<u>FLOW (GPM) *</u>
ATA	Ocean Tug	500
ATF	Ocean Tug Fleet	500
ATS	Salvage and Rescue Tug	500
AVM	Guided Missile Ship	1,500
CV, CVN	Aircraft Carrier	3,000
CG	Guided Missile Cruiser	1,000
DDG	Guided Missile Destroyer	1,000
FFG	Guided Missile Frigate	1,000
IX	Unclassified Miscellaneous	1,500
LCC	Amphibious Command Ship	1,000
LCS	Littoral Combat Ship	1,000
LHA**	Amphibious Assault Ship	2,500
LHD**	Amphibious Assault Ship	2,500
LPD***	Amphibious Transport Dock	1,500
LSD***	Landing Ship Dock	2,000
YRB	Repair and Berthing Barge	500
YRBM	Repair, Berthing and Messing Barge	500
YRBL	Repair, Berthing and Messing Barge (large)	500
LST	Landing Ship Tank	1,500
MCM	Mine Counter Measures Ship	750
PC	Patrol Coastal	500
PCH	Hydrofoil Patrol Craft	500
PG	Patrol Combatants	500
PGH	Hydrofoil Gunboat	500

\* All flows are from the pier or dry dock outlet and are available at adequate residual pressures from those systems in compliance with present design criteria for dry docks and piers as reflected in NAVFAC design manuals (UFC 4-213-10, UFC 4-213-12, UFC 4-152-01, UFC 4-150-02, and UFC 4-150-06).

\*\* Includes supply to operate 2 hangar sprinkler groups and 2, 2 and one-half-inch hose lines.

\*\*\* Includes supply to operate one sprinkler group and 2, 2 and one-half-inch hoses.

Attachment B

Hose Capacity (GPM)\*

SIZE (in.)	LENGTH (100ft.)	LENGTH (150ft.)	LENGTH (200ft.)	LENGTH (250ft.)
2 ½	300 GPM	225 GPM	200 GPM	175 GPM
3 ½	750 GPM	600 GPM	500 GPM	450 GPM
4	1000 GPM	825 GPM	700 GPM	650 GPM
Notes: *Based on 20 PSI total friction loss				

**ATTACHMENT C**

<b>Hot Work Notification Log</b>	
Ship name/hull number:	Location:
Date:	Log sheet #

Company/Command	HW <i>Coordinator</i> (Print Name)	HW <i>Auth Form</i> Serial #	Start Time	HW <i>Coordinator</i> Signature	End Time	HW <i>Coordinator</i> Signature	<i>HW Location</i>

## ATTACHMENT C

### HOT WORK NOTIFICATION LOG INSTRUCTIONS

- 1- Ship Name/Hull Number: Indicate ship name and hull number of the location of the walk thru.
- 2- Location: Indicate location where ship is moored or docked, i.e. name of contractor facility or pier at Naval Base or Station.
- 3- Date: Indicate date of when the log was put into service. New log will be used each day.
- 4- Log Sheet #: Indicate the log number by keeping a running total throughout the availability.
- 5- Company/Command: Indicate Company/Command conducting the hot work (i.e. prime contractor, sub-contractor, AIT, RMC, ship's force).
- 6- HW Coordinator: *Indicate by printing legibly the name of the Hot Work Coordinator responsible for managing HW authorization forms.*
- 7- HW Authorization Form Serial Number: *Indicate the serial number of the hot work notice for the hot work commencing.*
- 8- Start Time: *Indicate the start time of the hot work to commence for each shift.*
- 9- HW Coordinator Signature: *Signature of the Hot Work Coordinator affirming requested hot work authorization forms will be worked each shift.*
- 10- End Time: *Indicate the end time of the hot work for each shift. End Time*: *Indicate the end time of the hot work for each shift.*
- 11- HW Coordinator Signature: Signature of the Hot Work *Coordinator* affirming hot work has ended *and space is in a safe condition.*
- 12- HW Location: *Compartment number and noun name of location where HW will be accomplished.*

**ATTACHMENT D**

**LIMIT OF SUBMITTED HOT WORK AUTHORIZATION FORMS PER DAY PER SHIP CLASS**

<i>Ship Class</i>	<i>Hot Work limit Per Day</i>
<i>Amphibious Assault Ship (LHD, LHA) waterborne</i>	<i>100</i>
<i>Amphibious Assault Ship (LHD, LHA) in dry-dock</i>	<i>150</i>
<i>Command Ship (LCC) waterborne</i>	<i>75</i>
<i>Command Ship (LCC) in dry-dock</i>	<i>125</i>
<i>Amphibious Transport Dock (LPD) waterborne</i>	<i>75</i>
<i>Amphibious Transport Dock (LPD) in dry-dock</i>	<i>125</i>
<i>Dock Landing Ships (LSD) waterborne</i>	<i>100</i>
<i>Dock Landing Ships (LSD) in dry-dock</i>	<i>150</i>
<i>Guided Missile Cruiser (CG) waterborne</i>	<i>75</i>
<i>Guided Missile Cruiser (CG) in dry-dock</i>	<i>125</i>
<i>Guided Missile Destroyer (DDG) waterborne</i>	<i>75</i>
<i>Guided Missile Destroyer (DDG) in dry-dock</i>	<i>125</i>
<i>Littoral Combat Ship (LCS) waterborne</i>	<i>50</i>
<i>Littoral Combat Ship (LCS) in dry-dock</i>	<i>75</i>
<i>Mine Countermeasures Ship (MCM) waterborne</i>	<i>50</i>
<i>Mine Countermeasures Ship (MCM) in dry-dock</i>	<i>75</i>
<i>Patrol Coastal Ship (PC) waterborne</i>	<i>50</i>
<i>Patrol Coastal Ship (PC) in dry-dock</i>	<i>75</i>

ATTACHMENT E

Safety, Fire Prevention, and Housekeeping  
Discrepancy and Corrective Action Log

Fire Zone Boundaries

Attendees

Ship name/hull number:  
Location:  
Prime Contractor:  
Time:

Date:

No.	Point of Contact	Date Identified	Date Corrected	Location	Discrepancy	Corrective Action	Code

Type Codes: 1-Housekeeping, 2-Fire Prevent./Fire Equipment, 3-Hot Work., 4-FZ Boundary, 5-Electrical, 6-Compress Gas/Hoses/Bottles/Manifolds, 7-Scaffolding, 8-Egress/Exit, 9- Walking/Working Surfaces, 10-PPE, 11- Containment, 12-Unguarded/Edges/Holes/Openings/Fall Protection, 13- Confined/Enclosed Spaces, 14-Lines & Leads Hazards, 15-Equip. Adrift & Rollback, 16-Ventilation, 17-Machine Guarding/Hand Tools, 18- Crane/Rigging, 19-Environmental & Hazardous Material/Communication, 20-Environmental Protection, 21-General Safety



ATTACHMENT E

ESH DISCREPANCY AND CORRECTIVE ACTION LOG INSTRUCTIONS

- 1- Fire Zone Boundaries: List the designated Fire Zone Boundaries.
- 2- Attendees: List Company and or Command and names of personnel present for walk thru.
- 3- Ship Name/Hull Number: Indicate ship name and hull number of the location of the walk thru.
- 4- Location: Indicate location where ship is moored or docked, i.e. name of contractor facility or pier at Naval Base or Station.
- 5- Prime Contractor: Indicate prime contractor who has the contract with the SUPERVISOR.
- 6- Date: Indicate date of walk thru being accomplished.
- 7- Time: Indicate start time (24 hour clock) of walk thru being accomplished.
- 8- No. (number): List sequentially, each discrepancy noted during the walk thru. Number will continue where the numbering left off the previous day, until the end of the availability.
- 9- Point of Contact: Indicate Company/Command identified with the discrepancy (i.e. prime contractor, sub-contractor, AIT, RMC, ship's force).
- 10- Date Corrected: Date condition was corrected. If condition is not corrected, condition will be carried over to the next walk thru until condition is corrected.
- 11- Location: Indicate location of the condition, i.e. space number or frame number.
- 12- Discrepancy: Indicate condition that needs corrective action, be specific as necessary.
- 13- Corrective Action: Indicate corrective action taken to correct the condition and who is responsible for the corrective action.
- 14- Code: Indicate code, located at the bottom of ATTACHMENT A that condition can be grouped with, i.e. lines on deck causing trip hazard would use code 14- Lines and Leads Hazards.

Type Codes: 1-Housekeeping, 2-Fire Prevent./Fire Equipment, 3-Hot Work., 4-FZ Boundary, 5-Electrical, 6-Compress Gas/Hoses/Bottles/Manifolds, 7-Scaffolding, 8-Egress/Exit, 9- Walking/Working Surfaces, 10-PPE, 11- Containment, 12-Unguarded/Edges/Holes/Openings/Fall Protection, 13- Confined/Enclosed Spaces, 14-Lines & Leads Hazards, 15-Equip. Adrift & Rollback, 16-Ventilation, 17-Machine Guarding/Hand Tools, 18- Crane/Rigging, 19-Environmental & Hazardous Material/Communication, 20-Environmental Protection, 21-General Safety

**ATTACHMENT F**  
**FOR OFFICIAL USE ONLY**

<b>FIRE INCIDENT REPORT</b>		
Report #		
INITIAL REPORT <input type="checkbox"/>	REQUESTED UPDATE <input type="checkbox"/>	FINAL REPORT <input type="checkbox"/>

<u>CLASS OF FIRE:</u>	
<u>NAME(S) OF INJURED (if applicable):</u>	
<u>FIRE INCIDENT DATE:</u>	<u>COMPANY:</u>
<u>TIME:</u>	<u>SUPERVISOR:</u>
<u>LOCATION(S) OF INCIDENT:</u>	<u>WAF NUMBER:</u>
<u>CAUSE OF FIRE INCIDENT:</u>	<u>EQUIPMENT INVOLVED:</u>
<u>WORK ITEM NUMBER:</u>	<u>CONTRACT NUMBER:</u>

**WITNESS AND/OR INDIVIDUALS INVOLVED**

NAME(S)	DEPT.	COMPANY

**DESCRIPTION OF FIRE INCIDENT**

--

**DISPOSITION OF INJURED (if applicable)**

--

**IMMEDIATE CORRECTIVE ACTION**

--

**ATTACHMENT F**  
**FOR OFFICIAL USE ONLY**

INVESTIGATED BY (NAME):	TITLE:
SIGNATURE OF INVESTIGATOR:	DATE:
<b>FIRE INCIDENT REPORT</b>	
Report #	

**LONG TERM CORRECTIVE ACTION**

**ATTACHMENT F**  
**FOR OFFICIAL USE ONLY**

INVESTIGATED BY (NAME):	TITLE:
SIGNATURE OF INVESTIGATOR:	DATE:

Incident Report Instructions

REPORT NUMBER- Unique tracking number created by contractor

CLASS OF INCIDENT- i.e. Alpha, Charlie, Delta, Echo

NAME(S) OF INJURED- Self Explanatory

FIRE INCIDENT DATE: - Self Explanatory

TIME: - Self Explanatory

COMPANY: - Prime and subcontractors involved

SUPERVISOR – Supervisor of employee(s) involved

LOCATION(S) OF FIRE INCIDENT: - Installation, private yard, Ship name and hull number, space number(S) and compartment name(S)

WAF NUMBER – WAF assigned to the hot work being conducted or equipment being worked

**ATTACHMENT F**  
**FOR OFFICIAL USE ONLY**

CAUSE OF FIRE – i.e. Hot Work, industrial process, temporary service damage, temporary service malfunction

EQUIPMENT INVOLVED – Equipment working on and equipment being used to cause fire incident

WORK ITEM NUMBER – Work Item being accomplished when fire incident occurred

CONTRACT NUMBER: - Contract Number assigned by government agency i.e. RMC, Alteration Installation Team (AIT) Sponsor.

WITNESS AND/OR INDIVIDUALS INVOLVED – Name, company of witnesses and or individuals involved with the fire incident.

DESCRIPTON OF FIRE INCIDENT OR NEAR MISS – Short description of events leading up to the fire incident and extent of injuries and or damage to equipment.

DISPOSITION OF INJURED – i.e. Transported to hospital via ambulance or POV, transported to clinic, released from hospital, name of hospital or clinic, limited duty or loss time (if known).

IMMEDIATE CORRECTIVE ACTION – i.e. Scene/space secured, ship notified (who and when), RMC notified (who and when) clean up of fire debris, equipment secured.

INVESTIGATED BY – Self Explanatory.

TITLE – Self Explanatory.

SIGNATURE OF INVESTIGATOR – Self Explanatory.

DATE – Self Explanatory.

LONG TERM CORRECTIVE ACTION – What action(s) were taken so that the fire incident does not reoccur, i.e. training, safety stand down or process/policy change.

ROOT CAUSE ANALYSIS – Process by which you will identify the cause or contributing factors of the fire incident.

Note: Attach additional information as necessary.

NAVSEA  
STANDARD ITEM

FY-24

ITEM NO: 009-09  
DATE: 25 OCT 2022  
CATEGORY: II

1. SCOPE:

1.1 Title: Process Control Procedure (PCP); provide and accomplish

2. REFERENCES:

2.1 Standard Items

3. REQUIREMENTS:

3.1 Submit one legible copy of each PCP, in approved transferrable media, to the SUPERVISOR for approval. For planned availabilities, submission must be no later than 14 days prior to start of the required process, or as otherwise approved by the SUPERVISOR. At a minimum, Attachment A must be used for PCP development; ensure each element is contained within its respective section. (See NOTE 4.2)

(V)(G) "START OF PROCEDURE"

3.2 Provide notification to the SUPERVISOR when ready to start the PCP.

3.2.1 Verify the PCP is approved.

3.2.2 Verify necessary parts and equipment are on hand to start work.

3.2.3 Attend job briefing conducted prior to start of work, to include personnel safety brief with ship's force. Specific to craft, ship's force attendance is not required.

3.2.3.1 The safety brief must include a hand-over-hand inspection and verification of the tagged-out piping/mechanical/ electrical system when accomplishing work in Collection, Holding, and Transfer (CHT) and Motor Gasoline (MOGAS) tanks, spaces, or associated piping, including Sewage or MOGAS contaminated tanks, spaces, and piping.

3.3 Accomplish the requirements of the approved PCP.

3.4 Make pen-and-ink editorial changes to the PCP when required after work commences. Editorial changes are limited to those correcting typographical errors and do not create a technical change as defined in 3.5.

3.5 Submit one legible copy, in approved transferrable media, of a report to the SUPERVISOR identifying any technical changes required after work has commenced and prior to proceeding with the affected procedural steps. Technical changes include any change to work

scope, work location, work sequence, testing, technical parameters (torque, test pressure, flow rate, etc.), material, inspections, repair processes, references, or change which otherwise alters any technical aspect of the work.

3.5.1 Make technical changes to the PCP and proceed when approved by the SUPERVISOR.

3.6 Unless otherwise approved by the SUPERVISOR, complete and submit one legible copy of Attachment B in hard copy or approved transferrable media within three days of completion of production work and prior to equipment operation or testing.

3.7 Submit one legible copy, in hard copy or approved transferrable media, of the completed process control documentation to the SUPERVISOR within 3 days of completion of the PCP or a minimum of 5 days prior the scheduled key event to which the PCP is tied. Documentation includes only completed OQE forms, signature records, or other recorded data obtained in the course of executing the PCP. Any previously submitted reports required by the body of the PCP or the associated Work Item do not require re-submission.

4. NOTES:

4.1 A PCP is considered a report if data is recorded.

4.2 For boats and craft 65 feet and less in length modify section 3.1 to “Submit one legible copy of each PCP, in approved transferrable media, to the SUPERVISOR once approved by contractor. For planned availabilities, submission must be no later than 24 hours prior to start of the required process, or as otherwise approved by the SUPERVISOR. Attachment A is provided as suggestion to be used for PCP development.”

ATTACHMENT A  
Process Control Procedure (PCP) Requirements

Section One - Identification

- Include the Process Title and Procedure Number with revision on each page.
- List the Ship's name, Work Item and paragraph that the PCP fulfills.
- Include contractor/subcontractor's name and address.
- Include space for the Approval Signature and title of the contractor's representative. Include spaces for the Date Developed, Date of Submission and scheduled start date.
- If submitting a previously approved PCP, include the previous Government approval letter (if appropriate) and attach a letter of intent to use the PCP with the updated information required by this section. A revision of Section 1 of the previously approved PCP is not required. A previously approved PCP is defined as one that has been approved by the SUPERVISOR for a like system or component.

Section 2 - Personnel Qualifications

- List the qualifications of the personnel performing the work.
- Include a statement that a briefing will be conducted prior to beginning work to ensure personnel have direct knowledge of the requirements of the procedure and the safety requirements of the job.

Section 3 - Process Description

- Method utilized to control the procedure.
- List any specialized or critical equipment needed to perform the work.
- List any specialized or critical personnel safety equipment.
- State that Government Notification (V)(G) will be made at the start of the process as applicable.
- Describe the process as related to the sequence of work, including each critical factor which has a direct bearing on the process quality and safety.
- Provide inspections required for the process, to include (V), (I), and (G) symbols invoked by the Work Item applicable to the process.
- Provide inspection and documentation forms applicable to the process.
- List the acceptance and rejection criteria used for determining satisfactory process completion.
- Include a statement that a copy of the PCP will be provided at the work site during the performance of the work.

Section 4 - Hazardous Material

- State if no hazardous material/waste will be used or generated.
- Identify any hazardous material/waste used or generated during the performance of work.
- Describe the methodology to limit the quantity that will require control.
- Describe the methods of the disposal of hazardous material or hazardous waste.



ATTACHMENT B

PCP Completion

SHIP'S NAME:	HULL #:
WORK ITEM #:	SSP #:
PCP # & TITLE:	

All production work required by the PCP (original, new and growth) has been satisfactorily reviewed, accurate and complete. All non-conformances have been corrected or properly adjudicated.

- 1) All Tests and Inspections up to and including step #\_\_\_\_\_ have been completed, satisfactorily reviewed, accurate and properly documented in the T&I Plan.
- 2) All required reports and all accompanying required data have been submitted, is accurate and satisfactorily reviewed.
- 3) Equipment is ready for operational testing.

RESULTS/STATUS:

- Complete
- Complete w/ Discrepancies
- Incomplete

Comments:

---

---

---

---

---

---

---

---

Print and Sign Name: \_\_\_\_\_ Date: \_\_\_\_\_

Position and Responsibility: \_\_\_\_\_

NAVSEA  
STANDARD ITEM

FY-24

ITEM NO: 009-10  
DATE: 25 OCT 2022  
CATEGORY: I

1. SCOPE:

1.1 Title: Asbestos-Containing Material (ACM); control

2. REFERENCES:

2.1 29 CFR 1915.1001, Occupational Safety and Health Standards for Shipyard Employment, Asbestos

2.2 MIL-STD-769, Insulation Requirements for U.S. Naval Vessels

2.3 40 CFR Part 61, National Emission Standards for Hazardous Air Pollutants

3. REQUIREMENTS:

3.1 Consider shipboard insulation, lagging, deck tile, underlayment, gasket, shipboard cabling (see 4.2), and mastic to be asbestos-containing material (ACM) until it can be established by laboratory analysis, or other reliable method(s), that the material does not contain asbestos, in accordance with 2.1. This includes reusable covers as defined in 2.2.

3.1.1 Material containing asbestos that requires removal for interference must be disposed of in accordance with 3.6.

3.1.2 Submit one legible copy, in approved transferrable media, of a report listing location and system identification of asbestos removed and non-asbestos installed which has not been identified elsewhere in the Job Order, to the SUPERVISOR.

3.2 Apply the following requirements for the removal, disturbance, or disposal of all asbestos containing materials during the initial monitoring, daily monitoring, and control of ACM throughout the work areas, and to Class I, II, III, or IV activities as defined in 2.1.

3.2.1 Ensure that responsibilities for personnel safety and environmental control of ACM existing or damaged during accomplishment of work are assigned and implemented.

3.2.1.1 Plan for the removal of ACM up to the specified amount provided in Attachment A.

3.2.1.2 If the total costs are less than the cost to remove the authorized square footage, remaining funds will be subject to recoupment. The contractor is not authorized to exceed these limits.

3.2.2 Maintain written substantiation of the credentials of the Qualified Person.

3.2.2.1 The Qualified Person must take airborne samples, monitor work practices, maintain daily logs, conduct on-site inspections, set up regulated areas, be capable of specifying the necessary protection and precautions to be taken during work with ACM, and accomplish the other requirements in accordance with Class I, II, III, and IV activities as defined in 2.1. The Qualified person must have successfully completed an initial EPA or state approved 40-hour Asbestos Supervisor's Course and annual refreshers.

3.2.2.2 Individuals performing airborne asbestos analysis must have successfully completed a NIOSH 582 course or equivalent and be rated proficient in either AIHA's PAT program or AAR program. Persons performing analysis of fiber type on bulk samples must have completed a McCrone Course in analysis of bulk asbestos samples and be rated proficient in either the NVLAP or AIHA's asbestos program.

3.2.2.3 Copies of certifications, licenses, notifications (such as advance notification to OSHA of new or modified control technology to be used to reduce exposure), and other documentation required by federal, state, and local regulatory authorities, must be maintained at the worksite.

3.2.3 Identify removal routes and steps to be taken to protect insulation, repair damaged insulation, and to avoid asbestos contamination along those routes and obtain SUPERVISOR approval prior to proceeding.

3.2.4 Submit one legible copy, in approved transferrable media, of notifications made to regulatory authority, regarding ACM removal, to the SUPERVISOR within 2 days of providing such notices to the regulatory authority.

3.2.5 Submit a written notice to the SUPERVISOR and to the Commanding Officer's designated representative, and post at the Ship's Quarterdeck or other designated location for each job or separate area of ACM removed or damaged aboard ship where there may be ACM at least 4 hours, but not more than 24 hours, prior to the start of work. The notice must contain the following information:

3.2.5.1 Ship's name and hull number

3.2.5.2 Work Item number

3.2.5.3 Compartment

3.2.5.4 Class of activity and type of insulation, lagging, deck tile, underlayment, and mastic, i.e., ACM or possible ACM (provide basis for determination)

3.2.5.5 Date and time to start to work

3.2.5.6 Deliver notification for work planned over a weekend or Monday following that weekend to the Commanding Officer's designated representative no later than 0900 on the Friday immediately preceding that weekend.

3.2.5.7 Deliver notification of work planned on a federal holiday and on the day following the federal holiday to the Commanding Officer's designated representative no later than 0900 of the last working day preceding the federal holiday.

3.2.6 Personnel accomplishing ACM work must have a direct knowledge of the requirements of this procedure prior to beginning work. All training must be under the direct supervision of a Qualified Person.

3.2.7 Monitor the affected areas daily to ensure compliance with 2.1. Monitoring must include adjacent spaces to ensure the work area containments and work practices are effective. Results of surveillance must be documented and the documentation must be provided to the SUPERVISOR.

3.2.8 Submit one legible copy, in approved transferrable media, of a list of regulated areas, decontamination areas, and engineering controls to be established in accordance with 2.1, to the SUPERVISOR.

3.2.8.1 Identify configuration of critical barriers or isolation methods.

3.2.8.2 Identify location/configuration of decontamination areas, including the equipment room, shower (if necessary), and clean change room.

3.2.8.3 Identify ventilation and filtration requirements, including the negative pressure enclosure(s) if necessary.

3.2.9 Isolate or blank the ship's ventilation systems in work areas to prevent asbestos contamination.

3.3 Post prominent warning signs as required by 2.1 outside of regulated areas.

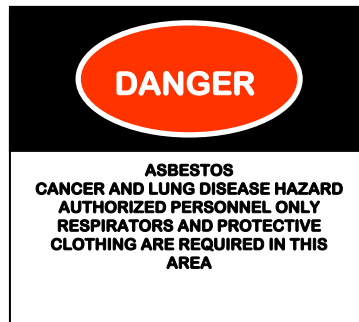

3.4 Monitor work areas.

3.4.1 Determine areas of airborne concentrations and potential personnel exposure to airborne asbestos fibers in accordance with the requirements of 2.1.

3.4.2 Take air samples and monitor regulated areas in the vicinity of access openings that are not tightly secured.

3.4.2.1 If the airborne concentration of asbestos fibers is at, or exceeds, 0.1 fiber, longer than 5 micrometers, per cubic centimeter of air, corrective action must be taken to reduce the concentration to less than 0.1 fiber, longer than 5 micrometers, per cubic centimeter of air.

3.5 Accomplish ACM removal as follows:

3.5.1 Secure and tag out ventilation systems securing the work area.

3.5.1.1 Blank ventilation systems to prevent contamination of the ventilation systems and other compartments.

3.5.2 Air discharged to the environment from any containment zone must have passed through a HEPA filter and otherwise conform to 2.3. A negative pressure will be maintained in the containment area where possible.

3.5.3 Remove materials which may contain ACM, using wet work practices and engineering controls that will minimize airborne contamination in and adjacent to the work area.

3.5.3.1 Removal tools and work practices must minimize the generation of airborne contamination and the deposit of ACM in the work area.

3.5.3.2 Equip vacuum cleaners used to help prevent the dispersion of asbestos fibers with HEPA filters.

3.5.3.3 Clear the work area of loose ACM, including ACM dust, prior to returning the area to normal status.

3.5.4 Contain edges of insulation exposed by removal operations by cutting the exposed surface true and square and sealing the surface. Encapsulate exposed ACM surfaces with insulating cement conforming to ASTM C 195.

3.6 Dispose of ACM by bag method described below:

3.6.1 Collect and dispose of ACM waste, scrap, debris, and special clothing consigned for disposal, which may produce airborne concentrations of asbestos fibers, in sealed, impermeable polyethylene bags (minimum thickness, 6 mils). Prior to placing in bags, asbestos waste must be wet down to reduce airborne concentrations of asbestos fibers.

3.6.2 Bag ACM scrap, debris, and waste at the worksite.

3.6.3 ACM must be placed in sealed, 6-mil or heavier, impermeable polyethylene bags before removal from the work area. Pieces of insulation too large to fit into bags must be encased in 6-mil, or heavier polyethylene film with edges sealed with tape conforming to MIL-C-20079.

3.6.4 Vacuum outer surfaces of bags containing ACM in affected areas immediately after removal from and adjacent to the worksite.

3.6.5 Place the ACM waste while wet in leak-tight double bags.

3.6.6 Label each bag, in accordance with 2.1 and 2.3, prior to removal from regulated areas.

3.6.7 Affix a legible label to each bag stating the contractor's name, the name of the ship the asbestos was removed from, the name of the facility where the work was performed and date of the removal. The label must be in permanent waterproof marking.

3.6.8 Dispose of bags containing ACM waste in accordance with applicable federal, state, and local regulations. Provide a copy of the completed Waste Shipment Record to the SUPERVISOR within 15 days after initial shipment.

3.7 Monitor the area for asbestos upon completion of work and after cleanup.

3.7.1 The airborne concentration of asbestos fibers after work and cleanup must be less than 0.1 fiber, longer than 5 micrometers, per cubic centimeter of air on an 8-hour, time-weighted average basis. The workspace must not be released for entry of unprotected personnel until verification has been provided to the SUPERVISOR that the airborne level of asbestos is less than the 0.1 fiber level.

3.7.1.1 Submit one legible copy, in approved transferrable media, of the lab analysis listing results of air monitoring certifying the area to be less than 0.1 asbestos fiber longer than 5 micrometers per cubic centimeter of air, to the SUPERVISOR.

3.8 Remove ACM from salvage or scrap equipment, piping, and structural components prior to delivery to the GOVERNMENT.

4. NOTES:

4.1 See additional notification requirements of NAVSEA Standard Item 009-01.

4.2 Shipboard cabling as used in 3.1 refers to all shipboard cabling, with the exception of low smoke, coaxial cables, and lamp cord cabling.

4.3 The following ACB circuit breakers listed by manufacturer contain non-friable asbestos arc chutes:

4.3.1 SPD, ITE, ITE/Gould: 640R, 900RC, 901R, 1600R, 1600HR, 1600HRC, 2000HR, 2000RC (450V), 2601R, 2801R, 3200HR, 4000HR.

4.3.2 General Electric: All types.

4.3.3 Westinghouse: All DBN types.

4.4 The term "asbestos fibers" is defined in 2.1.

4.5 Salvage - Property has some value in excess of its basic material content, but repair or rehabilitation to use for the originally intended purpose is clearly impractical. Repair for any use would exceed 65 percent of the original acquisition cost.

4.6 Scrap - Material that has no value except for its basic material content.

ATTACHMENT A  
AUTHORIZED ASBESTOS REMOVAL PER SHIP CLASS

<u>Ship Class</u>	<u>Square Foot of Removal</u>
Air Craft Carriers (CVN)	200
Amphibious Assault Ships (LHD, LHA)	150
Amphibious Command Ships (LCC)	150
Guided Missile Cruisers (CG)	150
Amphibious Transport Docks (LPD)	100
Amphibious Dock Landing Ships (LSD)	100
Guided Missile Destroyers (DDG)	100
Submarines (SSGN, SSBN, SSN)	50
Littoral Combat Ships (LCS)	50
Mine Counter Measures Ships (MCM)	50
Coastal Patrol Ships (PC)	50
Repair and Berthing Barge (YRB, YRBM)	50

NAVSEA  
STANDARD ITEM

FY-24

ITEM NO: 009-11  
DATE: 25 OCT 2022  
CATEGORY: II

1. SCOPE:

1.1 Title: Insulation and Lagging; accomplish

2. REFERENCES:

2.1 Standard Items

2.2 MIL-STD-769, Insulation Requirements for U.S. Naval Vessels

2.3 804-5959212, Surface Ship Machinery Insulation - Installation Details

2.4 804-5959214, Piping Insulation - Installation Details

2.5 804-5773931, Insulation for Compartments, Acoustic and Thermal Installation Details

2.6 804-5773932, Insulation for Ducts, Acoustic and Thermal, Installation Details

2.7 803-5184182, Insulation, Passive Fire Protection - Installation Details

2.8 46 CFR Part 164, Materials

2.9 S4823-C-3160935, Fasteners for Insulation & Lagging

3. REQUIREMENTS:

3.1 Install new insulation, lagging, and reusable covers in accordance with 2.2 through 2.7, and the following:

3.1.1 Use of elastomeric foam conforming to MIL-P-15280 is not permitted.

3.1.2 MIL-PRF-32585 insulation must not be installed on hot piping above one-inch Nominal Pipe Size (NPS) and must be installed only on piping with a vertical orientation or in low traffic areas.

3.1.3 Install insulation, anti-sweat and refrigerant, thermal foam conforming to MIL-PRF-32514 on anti-sweat and refrigeration piping systems that have an operating temperature of minus 20 degrees to 180 degrees Fahrenheit. (See Note 4.6)

3.1.3.1 Install with adhesive conforming to MIL-A-24179.



3.1.3.2 Install rewettable fibrous glass cloth lagging conforming to MIL-C-20079, Type I, Class 6 or 8, in high traffic areas. In addition to the requirements of MIL-C-20079, rewettable lagging must meet the requirements of Section 164.009-3 of 2.8, unless otherwise approved by NAVSEA.

3.1.4 Utilize Polyimide foam insulation conforming to MIL-DTL-24688, Type I, for piping and machinery systems other than systems listed in 3.1.3, and with a maximum operating temperature of 400 degrees Fahrenheit.

3.1.5 Accomplishment of welding, fabrication, and inspection requirements for new fasteners (studs) to support insulation and lagging must be in accordance with NAVSEA Standard Items (See Note 4.3).

3.1.6 Accomplishment of cleaning and painting requirements for surfaces to be insulated with the exception of non-ferrous and corrosion resistant steel (CRES) piping, plating, and vent ducting must be in accordance with NAVSEA Standard Items (See Note 4.4).

3.1.7 Secure reusable covers using snap fasteners or laced with copper, brass or soft steel galvanized wire through hooks or rings in accordance with 2.9.

3.1.7.1 Stamp the surface of the lacing washers, piece 200 of 2.8, on the reusable cover with one quarter inch high letters, NO AB, located close to the outer edge of the washer and visible when the reusable cover is installed.

3.2 Accomplishment of cleaning and painting requirements for new insulation, lagging, and reusable covers to match surrounding areas must be in accordance with NAVSEA Standard items (See Note 4.5).

#### 4. NOTES:

4.1 Known source for EB Spec. 4013:

General Dynamics Company  
Dept. 447 Material Services  
Attn: K. Hamler  
75 Eastern Point Road  
Groton, CT 06340-4899  
Tel: 860-433-2373

4.2 Known sources for rewettable fibrous glass cloth lagging:

BGF Industries, Inc. 3802 Robert Porcher Way Greensboro, NC 27410 Tel: 800-925-1961	Alpha Associates Two Amboy Avenue Woodbridge, NJ 07095 Tel: 732-634-5700
--	---

4.3 If welding of fasteners (studs) to support lagging and or insulation of 3.1.5 is required; the use of Category II Standard Item 009-12 "Welding, Fabrication, and Inspection Requirements; accomplish" of 2.1 will be specified in the Work Item.

4.4 If surfaces are to be insulated with the exception of non-ferrous and corrosion resistant steel (CRES) piping, plating and vent ducting of 3.1.6 is required; the use of Category II Standard Item 009-32 "Cleaning and Painting Requirements; accomplish" of 2.1 will be specified in the Work Item.

4.5 If cleaning and painting for the new insulation, lagging, and reusable covers to match surrounding areas of 3.2 is required; the use of Category II Standard Item 009-32 "Cleaning and Painting Requirements; accomplish" of 2.1 will be specified in the Work Item.

4.6 "Electric Boat Specification No. 4013 Anti-Sweat and Refrigerant Insulation Systems (EB Spec. 4013) and MIL-PRF-32514 are equivalent."

NAVSEA  
STANDARD ITEM

FY-24

ITEM NO: 009-12  
DATE: 25 OCT 2022  
CATEGORY: II

1. SCOPE:

1.1 Title: Weld, Fabricate, and Inspect; accomplish

2. REFERENCES:

2.1 Standard Items

2.2 MIL-STD-1689, Fabrication, Welding, and Inspection of Ships Structure

2.3 American Bureau of Shipping (ABS) Rules for Building and Classing Steel Vessels

2.4 0900-LP-060-4010, Fabrication, Welding, and Inspection of Metal Boat and Craft Hulls

2.5 S9074-AQ-GIB-010/248, Requirements for Welding and Brazing Procedure and Performance Qualification

2.6 0900-LP-001-7000, Fabrication and Inspection of Brazed Piping Systems

2.7 S9074-AR-GIB-010/278, Requirements for Fabrication Welding and Inspection, and Casting Inspection and Repair for Machinery, Piping, and Pressure Vessels

2.8 MIL-STD-22, Welded Joint Design

2.9 MIL-STD-2035, Nondestructive Testing Acceptance Criteria

2.10 T9074-AS-GIB-010/271, Requirements for Nondestructive Testing Methods

2.11 DOD-STD-2185, Requirements for Repair and Straightening of Bronze Naval Ship Propellers

2.12 S9221-C1-GTP-010/020, Main Propulsion Boilers; Repair and Overhaul

2.13 S9AA0-AB-GOS-010, General Specifications for Overhaul of Surface Ships (GSO)

2.14 MIL-STD-2191, Repair, Welding, Weld Cladding, Straightening, and Cold Rolling of Main Propulsion Shafting

2.15 S9CG0-BP-SRM-010/CG-47CL, Inspection, Testing, Fabrication, and Welding for Aluminum Superstructures During Repair, Alteration, and Modernization, for CG-47 Class Ships

- 2.16 TO300-AU-SPN-010, Fabrication, Welding and Inspection of Small Boats and Craft, Aluminum Hulls
- 2.17 S9086-RK-STM-010/CH-505, Piping Systems
- 2.18 S9LCS-BF-SRM-010/LCS-2, Inspection, Testing, Fabrication, and Welding for Structural Repair, Alteration, and Modernization, for LCS-2 Variant Ships
- 2.19 DM 18-829, Aluminum Welding Requirements for Littoral Combat Ship (LCS), Ships Applicable: LCS Class FREEDOM Variant (LCS-1V)

3. REQUIREMENTS:

3.1 Utilize specific requirements of 2.2 through 2.12 and 2.16 listed in Tables One, 2, 3, and 4 of this item for determining the welder and brazer qualifications, electrodes, weld design, welding requirements, brazing requirements, welding procedures, brazing procedures, welding parameters and controls, inspection standards, and acceptance criteria.

3.1.1 Maintain a Welding Workmanship Program and a Welding Surveillance Inspection Program if conducting structural and fabrication work in accordance with 2.2.

3.1.2 Maintain a Welding Training Program in accordance with 2.5.

3.1.3 Maintain a Brazing Process Inspection in accordance with 2.6.

3.2 Weld bell-end fittings in accordance with Section 505c8 of 2.13. Nondestructive testing inspection must comply with Class P-2 piping systems as defined by 2.7.

3.3 Ground welding machines, for purposes of providing a return path for welding current, using a grounding bar or lead which must be connected directly from the machine ground return connection to the ship's hull, sized on the basis of 1,000,000 Circular Mils per 1,000 amps per 100 feet, but in no event using less than a Number One cable (85,037 Circular Mils).

3.3.1 Welding machines used for welding on machinery, pressure vessels, or piping, rotating ordnance, electronic, or fire control equipment must have the ground return connection in the immediate vicinity of the work to ensure that current does not flow through bearings, pipe hangers, or other areas where arcing or high resistance paths exist. For ships constructed of non-magnetic materials, the ground return cables must be connected directly to the component being welded - as close to the weld zone as feasible.

3.3.2 Shipboard power distribution system must not be used as the power source for welding equipment unless approved by the SUPERVISOR. External power source must be used.

3.4 Accomplishment of a Process Control Procedure (PCP) for the specific welding, brazing, and inspection operations in 3.4.1 through 3.4.9 must be in accordance with NAVSEA Standard Items (See Note 4.1) and the following:

3.4.1 Class A-F, A-1, A-2, A-3, A-LT, P-1, P-LT, M-1, and T-1 welding, as defined by 2.7. These procedures must include, as a minimum, the information required by Paragraph 4.1.3 of 2.7 and supporting data such as a sketch of the weld repair areas and associated ship components. Joint numbers must not be duplicated on ship during the availability.

3.4.2 Class P-3a special category silver brazing, as defined by 2.6. The procedure must include, as a minimum, the information required by Sections 4 of 2.5.

3.4.2.1 All brazing of steam piping must conform to 2.6, Class P-3a special category, including ultrasonic inspection, for all pipe sizes .840 inch outer diameter or greater including any (existing) copper to (new) copper-nickel transition joints. Brazed joints must not be used in steam pipe sizes less than .840 inch outer diameter.

3.4.2.2 In steam systems, where brazed piping and fittings are to be reused, or piping has to be sized to achieve proper fit-up, the option for a 5X visual inspection for cracks listed in Sections 5.5.3, 5.10.1, and 5.10.2 of 2.6 must not be used; liquid penetrant inspection must be required.

3.4.3 For bronze propellers, using 2.11 for guidance.

3.4.4 For propellers other than bronze, using 2.7 for guidance.

3.4.5 For propulsion shafting and rudder stocks, using 2.14 for guidance.

3.4.6 For titanium-based materials, using 2.7 for guidance.

3.4.7 Accomplish aluminum welding and nondestructive testing for superstructure of CG-47 Class ships in accordance with 2.15 and 5XXX series aluminum structures for CG-47 class ships in accordance with 2.16.

3.4.8 Accomplish fabrication, aluminum welding and nondestructive testing of aluminum structures for LCS-2 variant ships in accordance with 2.18.

3.4.9 Accomplish fabrication, aluminum welding and nondestructive testing of aluminum structures for LCS-1 variant ships in accordance with 2.19.

3.5 The use of a permanent backing strap in accordance with Section 11, Paragraph 11.1 of 2.2 is specifically prohibited for ships unless detailed in the original weld joint design or when authorized by the SUPERVISOR. The use of a permanent backing strap is acceptable for small boats and crafts, in accordance with 2.4 and 2.16.

(I) or (I)(G) “NONDESTRUCTIVE TESTING”

3.6 Accomplish nondestructive testing in accordance with the following:

3.6.1 Manufacture, installation, and repair (welding, brazing, machining, or lapping) of Level I fittings or components:

3.6.1.1 Nondestructive Testing Visual Inspection - (I)

3.6.1.2 Nondestructive Testing Magnetic Particle, Liquid Penetrant and Ultrasonic Testing (Final Only) - (I)(G)

3.6.1.3 Nondestructive Testing Radiographic - (I)

3.6.2 Welding/brazing of Class P-1, P-LT, P-3a piping systems or Class A-F, A-1, A-2, A-3, A-LT, M-1, T-1 welding, and Class P-2.

3.6.2.1 Nondestructive Testing Visual Inspection - (I)

3.6.2.2 Nondestructive Testing Magnetic Particle, Liquid Penetrant and  
Ultrasonic Testing (Final Only) - (I)(G)

3.6.2.3 Nondestructive Testing Radiographic - (I)

3.6.2.4 Nondestructive Testing Visual Inspection (I)(G) materials S-51, S-52,  
S-53.

3.6.3 Welding on ship/craft listed in Attachment A hull or structure when required by  
the fabrication document:

3.6.3.1 Nondestructive Testing Visual Inspection - (I)

3.6.3.2 Nondestructive Testing Magnetic Particle, Liquid Penetrant and  
Ultrasonic Testing (Final Only) - (I)(G)

3.6.3.3 Nondestructive Testing Radiographic - (I)

3.6.4 Weight handling equipment manufacture and repair:

3.6.4.1 Nondestructive Testing Visual Inspection - (I)

3.6.4.2 Nondestructive Testing Magnetic Particle, Liquid Penetrant - (I)(G)

3.6.4.3 Ultrasonic Testing (Final Only) - (I)(G)

3.6.4.4 Nondestructive Testing Radiographic - (I)

3.6.5 Corrective maintenance within the certified boundaries of cranes (as defined in  
NSTM 589):

3.6.5.1 Nondestructive Testing Visual Inspection - (I)

3.6.5.2 Nondestructive Testing Magnetic Particle, Liquid Penetrant - (I)(G)

3.6.5.3 Ultrasonic Testing (Final Only) - (I)(G)

3.6.5.4 Nondestructive Testing Radiographic - (I)

3.6.6 Maintenance on aircraft launch and recovery equipment:

3.6.6.1 Nondestructive Testing Visual Inspection - (I)

3.6.6.2 Nondestructive Testing Magnetic Particle, Liquid Penetrant and  
Ultrasonic Testing (Final Only) - (I)(G)

3.6.6.3 Nondestructive Testing Radiographic - (I)

3.6.7 Invocation of Operational Pressure Test Option for Piping Systems in accordance  
with 2.17:

3.6.7.1 Nondestructive Magnetic Particle and Liquid Penetrant testing  
accomplished to satisfy Operational Pressure Test Option requirements in accordance with 11.1.2.6 of  
2.17 and not already required by 3.6.2.2. - (I)

(I)(G) "EVALUATION OF RT FILMS"

3.7 Accomplish RT film interpretation.

3.7.1 Provide the cognizant Government representative designated by the SUPERVISOR the evaluated radiographs and records within 2 days of the (G) point.

3.8 Provide and maintain a Welding Consumable Control System in accordance with 2.2, 2.3, 2.4, 2.6, 2.7, 2.11, 2.12, 2.14, 2.15, and 2.16, which covers the control and issuance of filler materials. The system must be described in a written procedure that must be submitted to the SUPERVISOR for review and approval prior to the initiation of production work. This procedure only requires a one-time submittal/approval unless the Standard Items change and/or references change or are updated. The Welding Consumable Control System must be subject to periodic conformity audits by the SUPERVISOR throughout the contract period.

3.9 Utilize Attachment A to define combatant and non-combatant vessels and applicable table.

3.10 Where requirements in the repair and testing instructions for propulsion boilers conflict, 2.12 must take precedence.

4. NOTES:

4.1 If a Process Control Procedure (PCP) for all specific welding, brazing, and inspection operations in 3.4.1 through 3.4.7 is required; the use of Category II Standard Item 009-09 "Process Control Procedure (PCP); provide and accomplish" of 2.1 will be specified in the Work Item.

4.2 For Navy boats and craft all paragraphs apply except the following: 3.4.2.1, 3.4.2.2, 3.4.3, 3.4.4, 3.4.5, 3.4.6, and 3.6.6.

4.3 For boats and craft 65 feet or less in length in lieu of welder and NDT inspector qualifications identified in Table 4 repair facilities may use commercial qualification/certification. Acceptable commercial standards are such as American Bureau of Shipping (ABS) American Welding Society (AWS) and American Society of Mechanical Engineers (ASME) as selected by the repair facility. The repair facility is responsible for maintaining appropriate procedures, materials and personnel qualifications and record keeping to show compliance, or if welding is subcontracted, for imposing the same requirements on the supplier.

TABLE 1  
WELDING, FABRICATION, AND INSPECTION OF PIPING, PRESSURE VESSELS, PROPELLERS, AND MACHINERY

L I N E	COLUMN	A	B	C	D		E
	SITUATION EVOLUTION	CLASS P-1, P-2 AND P-LT PIPING	CLASS P-3a SPECIAL CATEGORY, OTHER CLASS P-3a, AND P-3b PIPING	HARD FACING VALVE PARTS	CLASS A PRESSURE VESSEL	** PROPULSION BOILERS	*PROPELLERS (BRONZE)
1	WELDER AND BRAZER QUALIFICATION	S9074-AQ-GIB-010/248, PARAGRAPH 5	0900-LP-001-7000, SECTION 4	S9074-AQ-GIB-010/248, PARAGRAPH 5		S9221-C1-GTP-010/020	
2	WELDING PROCEDURE	S9074-AQ-GIB-010/248, PARAGRAPH 4	NOT APPLICABLE	S9074-AQ-GIB-010/248, PARAGRAPH 4	S9221-C1-GTP-010/020		DOD-STD-2185, PARAGRAPH 4
3	BRAZING PROCEDURE	NOT APPLICABLE	0900-LP-001-7000, SECTION 4	NOT APPLICABLE			
4	WELDING REQUIREMENTS	S9074-AR-GIB-010/278, PARAGRAPH 6	NOT APPLICABLE	S9074-AR-GIB-010/278, PARAGRAPH 6			MIL-STD-2185, PARAGRAPH 5

\* - PARAGRAPH 3.4.4 APPLIES  
\*\* - PARAGRAPH 3.10 APPLIES



TABLE 1  
WELDING, FABRICATION, AND INSPECTION OF PIPING, PRESSURE VESSELS, PROPELLERS, AND MACHINERY

L I N E	COLUMN	A	B	C	D		E
		SITUATION EVOLUTION	CLASS P-1, P-2 AND P-LT PIPING	CLASS P-3a SPECIAL CATEGORY, OTHER CLASS P-3a, AND P-3b PIPING	HARD FACING VALVE PARTS	CLASS A PRESSURE VESSEL	** PROPULSION BOILERS
5	FILLER MATERIAL	S9074-AR-GIB-010/278, PARAGRAPH 5	0900-LP-001-7000, SECTION 5	S9074-AR-GIB-010/278, PARAGRAPH 5		S9221-C1-GTP-010/020	DOD-STD-2185, PARAGRAPH 5
6	JOINT DESIGN	S9074-AR-GIB-010/278, PARAGRAPH 9 MIL-STD-22	0900-LP-001-7000, SECTION 5	NOT APPLICABLE	S9074-AR-GIB-010/278, PARAGRAPH 9 MIL-STD-22	S9221-C1-GTP-010/020	

\* - PARAGRAPH 3.4.4 APPLIES  
\*\* - PARAGRAPH 3.10 APPLIES

TABLE 1  
WELDING, FABRICATION, AND INSPECTION OF PIPING, PRESSURE VESSELS, PROPELLERS, AND MACHINERY

	COLUMN	A	B	C	D		E
L I N E	SITUATION EVOLUTION	CLASS P-1, P-2 AND P-LT PIPING	CLASS P-3a SPECIAL CATEGORY, OTHER CLASS P-3a, AND P-3b PIPING	HARD FACING VALVE PARTS	CLASS A PRESSURE VESSEL	** PROPULSION BOILERS	*PROPELLER S (BRONZE)
7	HEAT TREATMENT	S9074-AR-GIB- 010/278, PARAGRAPH 6	0900-LP-001- 7000, SECTION 5	S9074-AR- GIB-010/278, PARAGRAPH S 6 AND 11.6	S9074-AR- GIB-010/278, PARAGRAPH H 6	S9221-C1-GTP- 010/020	S9074-AR- GIB-010/278, PARAGRAPH 6  DOD-STD- 2185, PARAGRAPH 5
8	WORKMANS HIP REQUIREMEN TS	S9074-AR-GIB- 010/278, PARAGRAPH 7	0900-LP-001- 7000, SECTION 5	S9074-AR- GIB-010/278, PARAGRAPH S 7 AND 11.6	S9074-AR- GIB-010/278, PARAGRAPH H 7	S9221-C1-GTP- 010/020	S9074-AR- GIB-010/278, PARAGRAPH 7

\* - PARAGRAPH 3.4.4 APPLIES  
\*\* - PARAGRAPH 3.10 APPLIES

TABLE 1  
WELDING, FABRICATION, AND INSPECTION OF PIPING, PRESSURE VESSELS, PROPELLERS, AND MACHINERY

L I N E	COLUMN	A	B	C	D		E
		SITUATION EVOLUTION	CLASS P-1, P-2 AND P-LT PIPING	CLASS P-3a SPECIAL CATEGORY, OTHER CLASS P-3a, AND P-3b PIPING	HARD FACING VALVE PARTS	CLASS A PRESSURE VESSEL	** PROPULSION BOILERS
9	VISUAL INSPECT JOINT FIT-UP	S9074-AR-GIB-010/278, PARAGRAPH 9 MIL-STD-22	0900-LP-001-7000, SECTION 7	NOT APPLICABLE	S9074-AR-GIB-010/278, PARAGRAPH 9 MIL-STD-22	S9221-C1-GTP-010/020	DOD-STD-2185, PARAGRAPH 5
10	VISUAL INSPECTION	S9074-AR-GIB-010/278, PARAGRAPH 10  MIL-STD-2035, PARAGRAPH 4	0900-LP-001-7000, SECTION 7 AND 8	S9074-AR-GIB-010/278, PARAGRAPH 11.6.3  MIL-STD-2035, PARAGRAPH 4	S9074-AR-GIB-010/278, PARAGRAPH 10  MIL-STD-2035, PARAGRAPH 4		MIL-STD-2035, PARAGRAPH 4

\* - PARAGRAPH 3.4.4 APPLIES  
\*\* - PARAGRAPH 3.10 APPLIES

TABLE 1  
WELDING, FABRICATION, AND INSPECTION OF PIPING, PRESSURE VESSELS, PROPELLERS, AND MACHINERY

L I N E	COLUMN	A	B	C	D	E	
		SITUATION EVOLUTION	CLASS P-1, P-2 AND P-LT PIPING	CLASS P-3a SPECIAL CATEGORY, OTHER CLASS P-3a, AND P-3b PIPING	HARD FACING VALVE PARTS	CLASS A PRESSURE VESSEL	** PROPULSION BOILERS
11	RADIOGRAPH IC INSPECTION (RT)	S9074-AR-GIB- 010/278 PARAGRAPH 10 T9074-AS-GIB- 010/271, PARAGRAPH 3  MIL-STD-2035, PARAGRAPH 5 (NORMALLY ONLY P-1 AND P-LT)	NOT APPLICABLE		S9074-AR-GIB-010/278 PARAGRAPH 10 T9074-AS-GIB- 010/271,PARAGRAPH 3  MIL-STD-2035, PARAGRAPH 5		NOT APPLICABLE
12	ULTRASONIC INSPECTION (UT)	NOT APPLICABLE	0900-LP-001- 7000, SECTIONS 6,7,8 AND 9 FOR CLASS P-3a SPECIAL CATEGORY PIPING ONLY	NOT APPLICABLE			S9245-AR- TSM- 010/PROP, PARAGRAPH 5-7.5.2

\* - PARAGRAPH 3.4.4 APPLIES  
\*\* - PARAGRAPH 3.10 APPLIES

TABLE 1  
WELDING, FABRICATION, AND INSPECTION OF PIPING, PRESSURE VESSELS, PROPELLERS, AND MACHINERY

L I N E	COLUMN	A	B	C	D		E
		SITUATION EVOLUTION	CLASS P-1, P-2 AND P-LT PIPING	CLASS P-3a SPECIAL CATEGORY, OTHER CLASS P-3a, AND P-3b PIPING	HARD FACING VALVE PARTS	CLASS A PRESSURE VESSEL	** PROPULSION BOILERS
13	LIQUID PENETRANT INSPECTION (PT)	S9074-AR-GIB- 010/278, PARAGRAPH 10 T9074-AS-GIB- 010/271, PARAGRAPH 5  MIL-STD-2035, PARAGRAPH 7 (NORMALLY ONLY P-1 AND P-LT)	0900-LP-001- 7000, SECTION 7 AND 8  FOR CLASS P-3a SPECIAL CATEGORY  SEE 3.4.2.2	S9074-AR- GIB-010/278, PARAGRAPH 11.6.3  MIL-STD- 2035, PARAGRAPH 7	S9074-AR-GIB-010/278, PARAGRAPH 10 T9074-AS-GIB-010/271, PARAGRAPH 5  MIL-STD-2035, PARAGRAPH 7		MIL-STD- 2035, PARAGRAPH 7 T9074-AS- GIB-010/271, PARAGRAPH 5

\* - PARAGRAPH 3.4.4 APPLIES  
\*\* - PARAGRAPH 3.10 APPLIES

TABLE 1  
WELDING, FABRICATION, AND INSPECTION OF PIPING, PRESSURE VESSELS, PROPELLERS, AND MACHINERY

L I N E	COLUMN	A	B	C	D	E
		SITUATION EVOLUTION	CLASS P-1, P-2 AND P-LT PIPING	CLASS P-3a SPECIAL CATEGORY, OTHER CLASS P-3a, AND P-3b PIPING	HARD FACING VALVE PARTS	CLASS A PRESSURE VESSEL ** PROPULSION BOILERS
14	MAGNETIC PARTICLE INSPECTION (MT)	S9074-AR-GIB-010/278, PARAGRAPH 10 T9074-AS-GIB-010/271, PARAGRAPH 4  MIL-STD-2035, PARAGRAPH 6 (NORMALLY ONLY P-1 AND P-LT)	NOT APPLICABLE		S9074-AR-GIB-010/278, PARAGRAPH 10 T9074-AS-GIB-010/271, PARAGRAPH 4  MIL-STD-2035 PARAGRAPH 6	NOT APPLICABLE

\* - PARAGRAPH 3.4.4 APPLIES  
\*\* - PARAGRAPH 3.10 APPLIES

TABLE 1

WELDING, FABRICATION, AND INSPECTION OF PIPING, PRESSURE VESSELS, PROPELLERS, AND MACHINERY

L I N E	COLUMN	F	G	H	I	J
	SITUATION EVOLUTION	MACHINERY CLASS M	TURBINE PARTS	CASTINGS	FORCED DRAFT BLOWERS	REDUCTION AND STEAM TURBINE DRIVEN AUXILIARY GEARS
1	WELDER AND BRAZER QUALIFICATIONS	S9074-AQ-GIB-010/248, PARAGRAPH 5				
2	WELDING PROCEDURE	S9074-AQ-GIB-010/248, PARAGRAPH 4				
3	BRAZING PROCEDURE	NOT APPLICABLE				
4	WELDING REQUIREMENTS	S9074-AR-GIB-010/278, PARAGRAPH 6				
5	FILLER MATERIAL	S9074-AR-GIB-010/278, PARAGRAPH 5				
6	JOINT DESIGN	S9074-AR-GIB-010/278, PARAGRAPH 9, AND MIL-STD-22				
7	HEAT TREATMENT	S9074-AR-GIB-010/278, PARAGRAPHS 6 AND 8				
8	WORKMANSHIP REQUIREMENTS	S9074-AR-GIB-010/278, PARAGRAPH 7				
9	VISUAL INSPECT JOINT FIT-UP	S9074-AR-GIB-010/278, PARAGRAPH 10, AND MIL-STD-22				
10	VISUAL INSPECTION	S9074-AR-GIB-010/278, PARAGRAPH 10  MIL-STD-2035, PARAGRAPH 4	S9074-AR-GIB- 010/278, PARAGRAPH 14	S9074-AR-GIB- 010/278, PARAGRAPH 13  MIL-STD-2035, PARAGRAPH 4	S9074-AR-GIB- 010/278, PARAGRAPH 16	S9074-AR-GIB- 010/278, PARAGRAPH 15

\* - PARAGRAPH 3.4.4 APPLIES  
 \*\* - PARAGRAPH 3.10 APPLIES

TABLE 1  
WELDING, FABRICATION, AND INSPECTION OF PIPING, PRESSURE VESSELS, PROPELLERS, AND MACHINERY

L I N E	COLUMN	F	G	H	I	J
	SITUATION EVOLUTION	MACHINERY CLASS M	TURBINE PARTS	CASTINGS	FORCED DRAFT BLOWERS	REDUCTION AND STEAM TURBINE DRIVEN AUXILIARY GEARS
11	RADIOGRAPHIC INSPECTION (RT)	S9074-AR-GIB-010/278, PARAGRAPH 10 T9074-AS-GIB-010/271, PARAGRAPH 3  MIL-STD-2035, PARAGRAPH 5	S9074-AR-GIB- 010/278, PARAGRAPH 14 T9074-AS-GIB- 010/271, PARAGRAPH 3  MIL-STD-2035, PARAGRAPH 5	S9074-AR-GIB- 010/278, PARAGRAPH 13	S9074-AR-GIB- 010/278, PARAGRAPH 16 T9074-AS-GIB- 010/271, PARAGRAPH 3  MIL-STD-2035, PARAGRAPH 5	NOT APPLICABLE

\* - PARAGRAPH 3.4.4 APPLIES  
\*\* - PARAGRAPH 3.10 APPLIES



TABLE 1  
WELDING, FABRICATION, AND INSPECTION OF PIPING, PRESSURE VESSELS, PROPELLERS, AND MACHINERY

L I N E	COLUMN	F	G	H	I	J
	SITUATION EVOLUTION	MACHINERY CLASS M	TURBINE PARTS	CASTINGS	FORCED DRAFT BLOWERS	REDUCTION AND STEAM TURBINE DRIVEN AUXILIARY GEARS
12	ULTRASONIC INSPECTION (UT)	S9074-AR-GIB- 010/278, PARAGRAPH 10 T9074-AS-GIB- 010/271, PARAGRAPH 6  MIL-STD-2035, PARAGRAPH 8	S9074-AR-GIB- 010/278, PARAGRAPH 14	S9074-AR-GIB- 010/278, PARAGRAPH 13	S9074-AR-GIB- 010/278, PARAGRAPH 16	S9074-AR-GIB- 010/278, PARAGRAPH 15
13	LIQUID PENETRANT INSPECTION (PT)	S9074-AR-GIB- 010/278, PARAGRAPH 10 T9074-AS-GIB- 010/271, PARAGRAPH 5  MIL-STD-2035, PARAGRAPH 7	S9074-AR-GIB- 010/278, PARAGRAPH 14 T9074-AS-GIB- 010/271, PARAGRAPH 5  MIL-STD-2035, PARAGRAPH 7	S9074-AR-GIB- 010/278, PARAGRAPH 13 T9074-AS-GIB- 010/271, PARAGRAPH 5  MIL-STD-2035, PARAGRAPH 7	S9074-AR-GIB- 010/278, PARAGRAPH 16 T9074-AS-GIB- 010/271, PARAGRAPH 5  MIL-STD-2035, PARAGRAPH 7	S9074-AR-GIB- 010/278, PARAGRAPH 15 T9074-AS-GIB- 010/271, PARAGRAPH 5  MIL-STD-2035, PARAGRAPH 7

\* - PARAGRAPH 3.4.4 APPLIES  
\*\* - PARAGRAPH 3.10 APPLIES

TABLE 1  
WELDING, FABRICATION, AND INSPECTION OF PIPING, PRESSURE VESSELS, PROPELLERS, AND MACHINERY

L I N E	COLUMN	F	G	H	I	J
	SITUATION EVOLUTION	MACHINERY CLASS M	TURBINE PARTS	CASTINGS	FORCED DRAFT BLOWERS	REDUCTION AND STEAM TURBINE DRIVEN AUXILIARY GEARS
14	MAGNETIC PARTICLE INSPECTION (MT)	S9074-AR-GIB- 010/278, PARAGRAPH 10 T9074-AS-GIB- 010/271, PARAGRAPH 4  MIL-STD-2035, PARAGRAPH 6	S9074-AR-GIB- 010/278, PARAGRAPH 14 T9074-AS-GIB- 010/271, PARAGRAPH 4  MIL-STD-2035, PARAGRAPH 6	S9074-AR-GIB- 010/278, PARAGRAPH 13 T9074-AS-GIB- 010/271, PARAGRAPH 4  MIL-STD-2035, PARAGRAPH 6	S9074-AR-GIB- 010/278, PARAGRAPH 16 T9074-AS-GIB- 010/271, PARAGRAPH 4  MIL-STD-2035, PARAGRAPH 6	S9074-AR-GIB- 010/278, PARAGRAPH 15 T9074-AS-GIB- 010/271, PARAGRAPH 4  MIL-STD-2035, PARAGRAPH 6

\* - PARAGRAPH 3.4.4 APPLIES  
\*\* - PARAGRAPH 3.10 APPLIES

TABLE 2  
WELDING, FABRICATION, AND INSPECTION OF SURFACE SHIP HULLS (COMBATANT)

	COLUMN	A	B	C	D	E	F
L I N E	MATERIAL EVOLUTION	CARBON STEEL (MS), ORDINARY STRENGTH STEEL(OS), AND HIGHER STRENGTH STEEL (HSS)	* (HY-80/100, HSLA-80 AND STS)	ALUMINUM ALLOY	CHROMIUM NICKEL STEEL (STAINLESS)	COPPER AND/OR NICKEL BASE ALLOYS	SILICONE BRONZE ALUMINUM BRONZE
1	WELDER QUALIFICATION	S9074-AQ-GIB-010/248, PARAGRAPH 5					
2	WELDING PROCEDURE	S9074-AQ-GIB-010/248, PARAGRAPH 4					
3	ELECTRODE	MIL-STD-1689, PARAGRAPH 10 TABLE X	MIL-STD-1689, PARAGRAPH 10 TABLE XI	MIL-STD-1689, PARAGRAPH 10 TABLE XVI	MI-STD-1689, PARAGRAPH 10 TABLES XII AND XIII	MIL-STD-1689, PARAGRAPH 10 TABLES XIV AND XV	S9074-AR-GIB-010/278, TABLE II
4	JOINT DESIGN	MIL-STD-22 MIL-STD-1689, PARAGRAPH 11					
5	WELDING REQUIREMENTS	MIL-STD-1689, PARAGRAPH 13					
6	WORKMANSHIP REQUIREMENTS	MIL-STD-1689, PARAGRAPHS 12 AND 14					
7	VISUAL	MIL-STD-1689, PARAGRAPHS 6, 7, AND 8 MIL-STD-2035, PARAGRAPH 4 T9074-AS-GIB-010/271, PARAGRAPH 8					

TABLE 2  
WELDING, FABRICATION, AND INSPECTION OF SURFACE SHIP HULLS (COMBATANT)

	COLUMN	A	B	C	D	E	F
L I N E	MATERIAL EVOLUTION	CARBON STEEL (MS), ORDINARY STRENGTH STEEL(OS), AND HIGHER STRENGTH STEEL (HSS)	* (HY-80/100, HSLA-80 AND STS)	ALUMINUM ALLOY	CHROMIUM NICKEL STEEL (STAINLESS)	COPPER AND/OR NICKEL BASE ALLOYS	SILICONE BRONZE ALUMINUM BRONZE
8	RADIOGRAPHIC INSPECTION (RT)	MIL-STD-1689, PARAGRAPHS 6, 7, AND 8 MIL-STD-2035, PARAGRAPH 5 T9074-AS-GIB-010/271, PARAGRAPH 3					
9	ULTRASONIC INSPECTION (UT)	MIL-STD-1689, PARAGRAPHS 6, 7, AND 8 MIL-STD-2035, PARAGRAPH 8 T9074-AS-GIB-010/271, PARAGRAPH 6					
10	LIQUID PENETRANT INSPECTION (PT)	MIL-STD-1689, PARAGRAPHS 6, 7, AND 8 MIL-STD-2035, PARAGRAPH 7 T9074-AS-GIB-010/271, PARAGRAPH 5					
11	MAGNETIC PARTICLE INSPECTION (MT)	MIL-STD-1689, PARAGRAPH 6 MIL-STD-2035, PARAGRAPH 6 T9074-AS-GIB-010/271, PARAGRAPH 4	NOT APPLICABLE				

TABLE 3

WELDING, FABRICATION, AND INSPECTION OF SURFACE SHIP HULLS (NON-COMBATANT) \* \*\*

	COLUMN	A	B	C	D	E	F
LINE	MATERIAL EVOLUTION	CARBON STEEL (MS), ORDINARY STRENGTH STEEL(OS), AND HIGHER STRENGTH STEEL (HSS)	*** (HY-80/100)	ALUMINUM ALLOY	CHROMIUM NICKEL STEEL (STAINLESS)	COPPER AND/OR NICKEL BASE ALLOYS	SILICONE BRONZE ALUMINUM BRONZE
1	WELDER QUALIFICATION	ABS RULES, PART 2, CHAPTER 4, SECTION 1					
2	WELDING PROCEDURE	ABS RULES, PART 2, CHAPTER 4, SECTION 1					
3	ELECTRODE	ABS RULES, PART 2, CHAPTER 4, SECTION 1					
4	JOINT DESIGN	ABS RULES, PART 2, CHAPTER 4, SECTION 1					
5	WELDING REQUIREMENTS	ABS RULES, PART 2, CHAPTER 4, SECTION 1					
6	WORKMANSHIP REQUIREMENTS	ABS RULES, PART 2, CHAPTER 4, SECTION 1					
7	VISUAL	ABS RULES, PART 2, CHAPTER 4, SECTION 1					
8	RADIOGRAPHIC INSPECTION (RT)	ABS RULES, PART 2, CHAPTER 4, SECTION 1					

TABLE 3  
WELDING, FABRICATION, AND INSPECTION OF SURFACE SHIP HULLS (NON-COMBATANT) \* \*\*

COLUMN	A	B	C	D	E	F	
L I N E	MATERIAL EVOLUTION	CARBON STEEL (MS), ORDINARY STRENGTH STEEL(OS), AND HIGHER STRENGTH STEEL (HSS)	*** (HY-80/100)	ALUMINU M ALLOY	CHROMIUM NICKEL STEEL (STAINLESS)	COPPER AND/OR NICKEL BASE ALLOYS	SILICONE BRONZE ALUMINUM BRONZE
9	ULTRASONIC INSPECTION (UT)	ABS RULES, PART 2, CHAPTER 4, SECTION 1					
10	LIQUID PENETRANT INSPECTION (PT)	ABS RULES, PART 2, CHAPTER 4, SECTION 1					
11	MAGNETIC PARTICLE INSPECTION (MT)	ABS RULES, PART 2, CHAPTER 4, SECTION 1	NOT APPLICABLE				

\* - IDENTIFICATION OF "SURVEYOR" IN ABS RULES SIGNIFIES SUPERVISOR OF SHIPBUILDING (SUPERVISOR) ACTION. THE SUPERVISOR MAY USE MIL-STD-1689 FOR GUIDANCE WHERE ADDITIONAL DIRECTION IS NECESSARY. SUCH GUIDANCE MAY BE USED TO: ESTABLISH NDT REQUIREMENTS, ESTABLISH

WELDING/NDT PROCEDURE AND PERSONNEL QUALIFICATION REQUIREMENTS, OR TO DEFINE OTHER ATTRIBUTES LISTED IN THE "MATERIAL EVOLUTION" LINE OF TABLE 3.

\*\* - THE SUPERVISOR MAY ALSO ALLOW THE SHIPBUILDER TO CHOOSE FROM THE FOLLOWING OPTIONS, PROVIDING:

- THE SHIPBUILDER'S UTILIZATION OF THE FOLLOWING OPTIONS MUST RESULT IN NO ADDITIONAL COST TO THE GOVERNMENT.

- THE SHIPBUILDER MUST UTILIZE THE FABRICATION DOCUMENT SELECTED FOR THE ENTIRE AVAILABILITY AND MUST NOT SWITCH BACK AND FORTH BETWEEN DOCUMENTS.

- THE SHIPBUILDER MUST NOTIFY THE SUPERVISOR OF WHICH FABRICATION DOCUMENT HAS BEEN SELECTED.

OPTIONS:

A) MIL-STD-1689 MAY BE UTILIZED BY THE SHIPBUILDER AT THE SHIPBUILDER'S DISCRETION. THE REQUIREMENTS OF TABLE 2 ABOVE WOULD THEN APPLY.

B) FOR DETERMINATION OF NDT METHOD(S) AND EXTENT OF NDT INSPECTION WHEN REPAIRS ARE TO BE ACCOMPLISHED, THE SHIPBUILDER MAY REQUEST TO UTILIZE THE SAME NDT REQUIREMENTS THAT WERE INVOKED IN CONSTRUCTION OF THE VESSEL. IN SUCH CASES, THE SHIPBUILDER MUST BE RESPONSIBLE TO DETERMINE THE ORIGINAL NDT REQUIREMENTS AND SUBMIT EVIDENCE SUCH AS DRAWINGS OR SPECIFICATIONS WHICH DETAIL THE REQUIREMENTS TO THE SUPERVISOR ALONG WITH A REQUEST FOR APPROVAL.

C) THE SHIPBUILDER MAY REQUEST TO UTILIZE PRE-ESTABLISHED WELDING AND/OR NDT PROCEDURES AND PERSONNEL QUALIFICATION PROGRAM(S) WHICH HAVE BEEN PREVIOUSLY UTILIZED IN THE PERFORMANCE OF SIMILAR ABS-ACCEPTED WORK. IN SUCH CASES, THE SHIPBUILDER MUST SUBMIT EVIDENCE OF SUCH ABS ACCEPTABILITY TO THE SUPERVISOR ALONG WITH DESCRIPTIVE DETAILS AND SUPPORTING DOCUMENTATION FOR THE PROPOSED PROGRAM(S). SUCH DOCUMENTATION MUST INCLUDE THE WELDING/NDT PROCEDURES AND METHODS OF WELDING/NDT PERSONNEL QUALIFICATION THAT WERE UTILIZED IN FORMER ABS-ACCEPTED WORK. THE SHIPBUILDER MUST ALSO SUBMIT OTHER SUPPORTING EVIDENCE THAT MAY BE REQUESTED BY THE SUPERVISOR TO

ESTABLISH THAT THE PROPOSED PROGRAMS HAVE BEEN PREVIOUSLY UTILIZED FOR SIMILAR ABS-ACCEPTED WORK.

\*\*\* - PARAGRAPH 3.8 APPLIES.



TABLE 4  
WELDING, FABRICATION, AND INSPECTION OF  
METAL BOAT AND CRAFT HULLS\*

L I N E	COLUMN	A	B	C	D	E	F
		MATERIAL EVOLUTION	CARBON STEEL (MS)	** (HY-80/100)	ALUMINUM ALLOY	CHROMIUM NICKEL STEEL (STAINLESS)	COPPER AND/OR NICKEL BASE
1	WELDER QUALIFICATION	S9074-AQ-GIB-010/248, SECTION 5		TO300-AU-SPN-010, SECTION 3.3	S9074-AQ-GIB-010/248, SECTION 5		
2	WELDING PROCEDURE QUALIFICATION	S9074-AQ-GIB-010/248, SECTION 4		TO300-AU-SPN-010, SECTION 3.2	S9074-AQ-GIB-010/248, SECTION 4		
3	ELECTRODE/FILLER MATERIAL	0900-060-4010, SECTION 10, TABLE 10-1	0900-060-4010, SECTION 10, TABLES 10-2 AND 10-3	TO300-AU-SPN-010, TABLES I AND II***	0900-060-4010, SECTION 10, TABLE 10-4	0900-060-4010 SECTION 10, TABLES 10-5 AND 10-6	S9074-AR-GIB-010/278, TABLE II
4	JOINT DESIGN	MIL-STD-22 0900-060-4010, SECTION 11		TO300-AU-SPN-010, SECTION 8 AND APPENDIX A AND APPENDIX B	MIL-STD-22 0900-060-4010, SECTION 11		
5	WELDING REQUIREMENTS	0900-060-4010, SECTION 13		TO300-AU-SPN-010, SECTION 10	0900-060-4010, SECTION 13		
6	WORKMANSHIP REQUIREMENTS	0900-060-4010, SECTIONS 12 AND 14		TO300-AU-SPN-010, SECTION 11	0900-060-4010, SECTIONS 12 AND 14		
7	VISUAL	0900-060-4010, SECTIONS 6, 7, AND 8 T9074-AS-GIB-010/271, SECTION 8		TO300-AU-SPN-010, SECTIONS 3.5.2.1, 5.4.1, 6.2, AND 7.2	0900-060-4010, SECTIONS 6, 7, AND 8 T9074-AS-GIB-010/271, SECTION 8		
8	RADIOGRAPHIC INSPECTION (RT)	0900-060-4010, SECTION 6, TABLE 6-1 AND SECTIONS 7 AND 8 T9074-AS-GIB-010/271, SECTION 3		TO300-AU-SPN-010, SECTIONS 3.5.2.4, 5.4.3, 6.4, AND 7.4	0900-060-4010, SECTION 6, TABLE 6-1 AND SECTIONS 7 AND 8 T9074-AS-GIB-010/271, SECTION 3		

9	ULTRASONIC INSPECTION (UT)	T9074-AS-GIB-010/271, SECTION 6 T9074-AS-GIB-010/271, SECTION 6		
10	LIQUID PENETRANT INSPECTION (PT)	0900-060-4010, SECTIONS 6, 7, AND 8 T9074-AS-GIB-010/271, SECTION 5	TO300-AU-SPN-010 SECTIONS 3.5.2.2, 5.5.3.4, 6.3, AND 7.3	0900-060-4010, SECTIONS 6, 7, AND 8 T9074-AS-GIB-010/271, SECTION 5
11	MAGNETIC PARTICLE INSPECTION (MT)	0900-060-4010, SECTION 6 T9074-AS-GIB-010/271, SECTION 4	NOT APPLICABLE	

\*- STRUCTURAL FABRICATION AND NON DESTRUCTIVE TESTING REQUIREMENTS FOR PATROL COASTAL (PC) CRAFT (PC-2 THRU PC-14) ARE ADDRESSED IN A SEPARATE TECHNICAL REPAIR STANDARD INVOKED IN STATEMENTS OF WORK (SOW) FOR PC REPAIRS AND MODIFICATIONS.

\*\* PARAGRAPH 3.8 APPLIES.

\*\*\*- SOME CRAFT ARE ORIGINALLY PROCURED WITH 6061 PLATING AND STRUCTURAL MEMBERS IN THE WELDED CONDITION. MODIFICATIONS TO SUBJECT CRAFT INVOLVE WELDING 5000 SERIES TO 6000 SERIES ALUMINUM AND ARE NOT ADDRESSED IN THE REFERENCED DOCUMENTS IN THIS STANDARD ITEM.

ATTACHMENT A  
COMBATANT SURFACE SHIPS

WARSHIPS

TABLE

Aircraft Carriers:

Aircraft Carrier .....	CV .....	2
Aircraft Carrier (nuclear propulsion) .....	CVN .....	2
Surface Combatants:		
Guided Missile Cruiser .....	CG .....	2
Guided Missile Destroyer .....	DDG .....	2
Guided Missile Frigate .....	FFG .....	2
Littoral Combat Ship .....	LCS .....	2
Patrol Combatants:		
Patrol Coastal .....	PC .....	4

AMPHIBIOUS WARFARE SHIPS

Amphibious Command Ship .....	LCC .....	2
Amphibious Assault Ship (general purpose) .....	LHA .....	2
Amphibious Cargo Ship .....	LKA .....	2
Amphibious Transport Dock .....	LPD .....	2
Dock Landing Ship .....	LSD .....	2
Amphibious Assault Ship (general purpose) .....	LHD .....	2

AUXILIARY SHIPS

Oiler .....	AO .....	2
Fast Combat Support Ship .....	AOE .....	2

MINE WARFARE SHIPS

Mine Countermeasures Ship .....	MCM .....	2
---------------------------------	-----------	---

NON-COMBATANT SURFACE SHIPS

AUXILIARY SHIPS

Auxiliary Crane Ship .....	ACS .....	3
Missile Range Instrumentation Ship .....	AGM .....	3
Oceanographic Research Ship .....	AGOR .....	3
Ocean Surveillance Ship .....	AGOS .....	3
Surveying Ship .....	AGS .....	3
Hospital Ship .....	AH .....	3
Cargo Ship .....	AK .....	3
Auxiliary Cargo Barge/Lighter Ship .....	AKB .....	3

ATTACHMENT A  
(Con't)  
NON-COMBATANT SURFACE SHIPS

TABLE

Auxiliary Cargo Float-On/Float-Off Ship .....	AKF. ....	3
Transport Oiler .....	AOT. ....	3
Barracks Craft .....	APL. ....	3
Cable Repairing Ship .....	ARC. ....	3
Salvage Ship .....	ARS. ....	3
Submarine Tender .....	AS. ....	3
Fleet Ocean Tug .....	ATF. ....	3
Aviation Logistic Support Ship .....	AVB. ....	3

BOATS AND CRAFTS

TABLE

Improved Navy lighterage system .....	(INLS) .....	4
Landing Craft, Air Cushion .....	LCAC. ....	4
Landing Craft, Mechanized .....	LCM. ....	4
Landing Craft, Personnel, Large .....	LCPL. ....	4
Landing Craft, Utility .....	LCU. ....	2
Light Seal Support Craft .....	LSSC. ....	4
Amphibious Warping Tug .....	LWT. ....	4
Maritime Prepositioning Force Utility Boat ...	MPFUB. ....	4
Medium Seal Support Craft .....	MSSC. ....	4
Side Loading Warping Tug .....	SLWT. ....	4
Special Warfare Craft, Light .....	SWCL. ....	4
Special Warfare Craft, Medium .....	SWCM. ....	4
Mini-Armored Troop Carrier .....	ATC. ....	4
Multi-Use EOD Response Craft .....	MERC. ....	4
Patrol Boat .....	PB. ....	4
River Patrol Boat .....	PBR. ....	4
Riverine Assault Boat .....	RAB. ....	4
Riverine Command Boat .....	RCB. ....	4
Dive Support Boat .....	DSB. ....	4
Combatant Craft Assault .....	CCA. ....	4
Combatant Craft Medium .....	CCM. ....	4
Combatant Craft Heavy .....	CCH. ....	4
Seal Delivery Vehicle .....	SDV. ....	4
Special Operations Craft-Riverine .....	SOC-R. ....	4
Shallow Water Combat Submersible .....	SWCS. ....	4
Surface Support Craft .....	SSC. ....	4

ATTACHMENT A  
(Con't)  
BOATS AND CRAFTS

TABLE

Small Auxiliary Floating Dry Dock (non-self-propelled) .....	AFDL.....	3
Medium Auxiliary Floating Dry Dock (non-self-propelled) .....	AFDM.....	3
Medium Auxiliary Repair Dry Dock (non-self-propelled) .....	ARDM.....	3
Causeway Section, Powered .....	CSP.....	3
Causeway Section (non-self-propelled) .....	CSNP.....	3
Unclassified Miscellaneous .....	IX.....	3
Open Lighter (non-self-propelled) .....	YC.....	3
Aircraft Transportation Lighter (non-self-propelled) .....	YCV.....	3
Cargo Semi-Submersible Barge .....	YCSS.....	3
Floating Crane (non-self-propelled) .....	YD.....	3
Diving Tender (non-self-propelled) .....	YDT.....	3
Ferryboat or Launch (self-propelled) .....	YFB.....	3
Covered Lighter (non-self-propelled) .....	YFN.....	3
Large Covered Lighter (non-self-propelled) .....	YFNB.....	3
Dry Dock Companion Craft (non-self-propelled) .....	YFND.....	3
Lighter (special purpose) (non-self-propelled) .....	YFNX.....	3
Floating Power Barge (non-self-propelled) .....	YFP.....	3
Salvage Lift Craft, Light .....	YLC.....	3
Gasoline Barge (non-self-propelled) .....	YOGN.....	3
Fuel Oil Barge (non-self-propelled) .....	YON.....	3
Oil Storage Barge (non-self-propelled) .....	YOS.....	3
Patrol Craft (self-propelled) .....	YP.....	4
Floating Workshop (non-self-propelled) .....	YR.....	3
Repair and Berthing Barge (non-self-propelled) .....	YRB.....	3
Repair, Berthing and Messing Barge (non-self-propelled) .....	YRBM.....	3
Floating Dry Dock Workshop (hull) (non-self-propelled) .....	YRDH.....	3
Floating Dry Dock Workshop (machine) (non-self-propelled) .....	YRDM.....	3
Radiological Repair Barge (non-self-propelled) .....	YRR.....	3
Seaplane Wrecking Derrick (self-propelled) .....	YSD.....	3
Large Harbor Tug .....	YTB.....	4
Small Harbor Tug .....	YTL.....	4
Torpedo Trials Craft .....	YTT.....	4
Water Barge (non-self-propelled) .....	YWN.....	3
Aircraft Rescue Boat .....	AR.....	4
Area Search Boat .....	AS.....	3
Armored Troop Carrier.....	AT.....	3
Barrier Boat .....	BB.....	3
Boom Platform Boat .....	BP.....	3

ATTACHMENT A  
(Con't)  
BOATS AND CRAFTS

TABLE

Dynamic Inclined Plane Oil Skimmer Boat .....	DP.....	3
Dive Support .....	DS.....	3
Dive Workboat.....	DW.....	3
Harbor Security Boat.....	DW.....	3
Marine Mammal Boat.....	MM.....	3
Missile Retriever Boat .....	MR.....	3
Non-Standard Boat .....	NS .....	4
Oil Pollution Skimmer Boat .....	OP .....	4
Parasail Training Boat .....	PS .....	4
Riverine Assault Boat .....	RAB .....	4
Riverine Command Boat .....	RCB .....	4
Riverine Patrol Boat .....	RPB .....	4
Support Craft .....	SC .....	4
Ships Non-Standard Boat .....	SX.....	4
Torpedo Retriever Boat .....	TR.....	4
Utility Boat .....	UB .....	4
Unmanned Craft .....	UC .....	4
Work Boat .....	WB .....	4
Work Platform Boat .....	WP .....	4
Warping Tug .....	WT .....	4
PE HV Barge (Self-Propelled) .....	AC.....	3
PE HV Barge (Self-Propelled) ....	CC.....	3
Large Auxiliary Floating Dry Dock (Self-Propelled) .....	AFBD.....	3
UB Small Dive / EOD MERC SSUB (Self-Propelled) .....	AP .....	4
UB Small Dive (Self-Propelled) ...	MC .....	4
SC HV (Self-Propelled) .....	MC .....	4
Deep Submergence Rescue Vehicle (Self-Propelled) .....	DSRV.....	4
Deep Submergence Vehicle (Self-Propelled) .....	DSV.....	4
Fast Sea Frame (Self-Propelled) .....	FSF.....	4
SC Large (Self-Propelled) .....	HL .....	4
FP Non-Standard (Self-Propelled) .....	HS.....	4
Non-Standard (Self-Propelled) .....	ML.....	4
Submersible Research Vehicle (Self-Propelled) .....	NR.....	4
FP Medium (Self-Propelled) .....	HS.....	4
FP Small / FP Non-Standard (Self-Propelled) .....	HS.....	4
FP Large (Self-Propelled) .....	HS.....	4
Unclassified Miscellaneous Submarine(Self-Propelled) .....	SS.....	3
Life Boat (Self-Propelled) .....	LB.....	4
Auxiliary Repair Dry Dock (Non-Self-Propelled).....	ARD.....	3
Mobile Radar Platform (Self-Propelled) .....	SBX.....	3

ATTACHMENT A  
(Con't)  
BOATS AND CRAFTS

TABLE

Sail STC (Self-Propelled) .....	ST.....	4
TWR (Self-Propelled) .....	TWR.....	3
Submersible Craft (Self-Propelled) .....	X .....	3
Miscellaneous Auxiliary Service Craft (Self-Propelled) .....	YAG.....	3
Car Float (Self-Propelled) .....	YCF.....	3
Waste oil barge (Non-Self-Propelled) .....	YWO.....	3
Water Barge (Self-Propelled) .....	YW.....	3
Medium Harbor Tug (Self-Propelled) .....	YTM.....	4
Harbor Tug (Self-Propelled) .....	YT.....	4
Sludge Removal Barge (Non-Self-Propelled) .....	YSR .....	3
Salvage Craft Tender (Non-Self-Propelled) .....	YRST.....	3
Floating Pile Driver (Non-Self-Propelled) .....	YPD.....	3
Gasoline Barge (Non-Self-Propelled) .....	YOGN .....	3
Fuel Oil Barge (Self-propelled) .....	YON .....	3
Gate Craft (Non-Self-Propelled) .....	YNG .....	3
Dredge (Non-Self-Propelled) .....	YMN.....	3
Garbage Lighter (Self-Propelled) .....	YG .....	3
Harbor Utility Craft (Self-Propelled) .....	YFU.....	3
Range Tender (Self-Propelled) .....	YFRT.....	3
Covered Lighter (Self-Propelled) .....	YF .....	3
Refrigerated Covered Lighter (Self-Propelled) .....	YFR.....	3
Refrigerated Covered Lighter (Non-Self-Propelled) .....	YFRN.....	3
Yard Floating Dry Dock (Non-Self-Propelled) .....	YFD.....	3
Aircraft Transportation Lighter (Non-Self-Propelled) .....	YCV .....	3
Paint Float.....	YR.....	3
Barrier Boats (BBs) .....	YTL.....	4
CVN Camels and Breasting Camels.....	YFNX.....	3
Submarine Camels.....	IX.....	3
WB Small (Self-Propelled) .....	BH.....	4
UB Medium (Self-Propelled) .....	BH.....	4
UB V Small (Self-Propelled) .....	BW.....	4
Non-Standard (Self-Propelled) .....	CA.....	4
WB Medium (Self-Propelled) .....	CM.....	4
NSWCCD (Self-Propelled) .....	PE.....	4
10MPE (Self-Propelled) .....	PE.....	4
PE Boat Medium (Self-Propelled) .....	PE.....	4
RX Small (Self-Propelled) .....	PE.....	4
AZ Memorial Ferry (Self-Propelled) .....	PE.....	4
SC Large (Self-Propelled) .....	PE.....	4
RX Small (Self-Propelled) .....	RB .....	4
RX 7M / RIB STD 7M (Self-Propelled) .....	RB .....	4

ATTACHMENT A  
(Con't)  
BOATS AND CRAFTS

TABLE

RX Large (Self-Propelled) .....	RB.....	4
RX Large / EOD MERC (Self-Propelled) .....	RX.....	4
RX Small (Self-Propelled) .....	RX.....	4
RX Medium (Self-Propelled) .....	RX.....	4

NOTES:

Letter prefixes to classification symbols may add identification:

E-- Prototype ship or craft in an experimental or developmental status.

T-- Assigned to MSC (Military Sealift Command)

F-- Being Constructed for a foreign government.

X -- Often added to existing classifications to indicate a new class whose characteristics have not been defined.



NAVSEA  
STANDARD ITEM

FY-24

ITEM NO: 009-13  
DATE: 25 OCT 2022  
CATEGORY: II

1. SCOPE:

1.1 Title: Meter, Gauge, Switch, and Thermometer; repair

2. REFERENCES:

- 2.1 Calibration Requirements List (CRL) for Shipboard Installed Instrumentation
- 2.2 NAVSEA OD 45845, Metrology Requirements List
- 2.3 S9300-A6-GYD-010, Electrical Workmanship Inspection Guide for Surface Ships and Submarines
- 2.4 ISO 17025, General Requirements for the Competence of Testing and Calibration Laboratories, First Edition
- 2.5 ANSI/NCSL Z540-3, Requirements for the Calibration of Measuring and Test Equipment
- 2.6 NAVSEA 04-04734, Naval and Marine Corps Calibration Laboratory Audit/Certification Manual
- 2.7 NAVAIR 17-35TR-8, Technical Requirements for Calibration Labels and Tags

3. REQUIREMENTS:

3.1 Prior to the installation verify instrument calibration requirements in applicable NAVSEA documentation to determine if the instrument requires calibration. Permanently installed instruments, are addressed by 2.1; all other non-installed instruments are addressed by 2.2.

3.1.1 If installing a calibrated instrument, the instrument must have at least two-thirds of its calibration life remaining. If it does not, the instrument must be calibrated in accordance with 3.7.

3.1.2 If the instrument is designated as No Calibration Required (NCR), perform a functional check to ensure proper functioning of the instrument if it is not required for system acceptance testing. Instrument identified as requiring calibration for system/acceptance testing/trials but designated as NCR in the ship's CRL, must be calibrated in accordance with 3.7 and must be labeled with a special calibration label NAVSEA 4734/6, and an NCR label NAVSEA 4734/26. For meters the special calibration label must be annotated to read, "CALIBRATION PERFORMED TO SUPPORT TESTING"; for gauges, switches and thermometers the calibration label must be annotated to read, "CALIBRATION PERFORMED TO SUPPORT TESTING. THIS LABEL MUST BE REMOVED UPON COMPLETION OF TESTING/TRIALS TO REFLECT THE CRL CAL-N (NCR) DESIGNATION OF THE

INSTRUMENT". All such special calibration labels must be removed and the instrument must have NCR labels affixed upon completion of testing/trials.

3.1.3 System or chain calibrations (designated as Level 2 in the ship's CRL) are not to be performed by commercial activities. For system calibration, contact the SUPERVISOR. Level 2 calibrated meters installed in systems must be subject to system or chain calibrations at the next available period. (See 4.5)

3.2 Disconnect and remove each meter and associated impeters, reactors, resistor boxes, and shunts.

3.2.1 Record and retain hook-up data and mounting hardware.

(V) "CONDITION OF WIRE LEADS"

3.2.1.1 Inspect lead wires and insulation; broken or partially broken lead wires must be cut back to remove damaged/questionable portions of the wire and new terminal ends installed in accordance with 2.3.

3.2.2 Remove existing and install new conductor identification sleeving in place of conductor identification sleeving identified to be illegible. Install new sleeving where missing. New conductor identification sleeving must conform to SAE-AMS-DTL-23053, Class One, white, marked with indelible ink.

3.3 Disconnect and remove each gauge, switch, and thermometer.

3.3.1 Remove sealed gauges as a complete unit.

3.3.2 Clear gauge lines from instrument side of root connection of obstructions by blowing clean, dry air through the lines.

3.4 Disassemble and clean equipment to remove loose paint and foreign matter.

3.4.1 Do not disassemble sealed gauge unit.

3.5 Repair each instrument and associated equipment to manufacturer's specifications.

3.5.1 Remove existing and install new components in place of those identified to be defective. Install new components where missing.

3.5.2 Free-up and adjust moving parts.

3.5.3 Restore unit cases to original finish.

3.6 Assemble equipment. Install new seals and gaskets conforming to manufacturer's specifications.

3.7 Calibrate and adjust each instrument, including associated accessories, to manufacturer's specifications, using appropriate calibration procedures and test equipment in accordance with 2.1 for permanently installed-instruments, or 2.2 for other/non-installed instruments.

3.7.1 Calibration laboratories must be accredited to either 2.4 or 2.5 by a Commercial Accreditation Activity, or certified by a Navy Certification Activity to 2.6. The

calibration laboratory's scope must include the parameters required to execute the calibration at the appropriate ranges and tolerances. Calibration must meet a minimum Test Accuracy Ratio (TAR) of 4:1, or a Test Uncertainty Ratio (TUR) equal to or greater than 4:1, or a Probability of False Accept (PFA) not to exceed 2 percent.

3.7.2 In the absence of manufacturer's specifications, tolerances must be in accordance with Section 1 of 2.2.

3.7.3 Affix a calibration label to the face of each instrument, denoting the name and location of the calibration facility, the NAVSEA Lab Code if assigned, the date of calibration, and date of next calibration. Department of the Navy calibration activities and Test, Measurement, and Diagnostic Equipment (TMDE) custodians must use calibration labels and tags in accordance with 2.7.

3.7.4 The calibration interval assigned for shipboard installed instrumentation must be in accordance with 2.1. All other meters must have a calibration interval assigned in accordance with 2.2.

3.7.5 Submit one legible copy, in hard copy and approved transferrable media (in Excel format), of a calibration events data file in accordance with Attachment A for each contractor and subcontractor-performed calibration event to the ship's Field Calibration Activity (FCA), Engineering/Maintenance Officer and AIMD Officer (if assigned) via the SUPERVISOR on a bi-weekly basis.

3.8 Install and connect each meter, including associated accessories, using hook-up data and mounting hardware retained in 3.2.1.

3.9 Install and connect each gauge, switch or thermometer, installing new seals, gaskets and fasteners.

#### 4. NOTES:

4.1 The SUPERVISOR will supply the contractor with a copy of the CRL provided by the Ship's Chief Engineer.

4.2 The SUPERVISOR will provide a copy of the calibration data to the Ship's Force Calibration Coordinator for the purpose of updating the ship's RECALL list.

4.3 NAVSEA 04RM3 Approved list of Accrediting Bodies (AB).

- . ANSI-ASQ National Accreditation Board (ANAB), <http://anab.org/>
- . Laboratory Accreditation Bureau (L-A-B), <http://l-a-b.com/>
- . Perry Johnson Registrars (PJLA), <http://www.pjr.com/>
- . The American Association for Laboratory Accreditation (A2LA), <https://www.a2la.org/>
- . National Voluntary Laboratory Accreditation Program (NVLAP), <https://www.nist.gov/nvlap>
- . International Accreditation Service (IAS), <http://www.iasonline.org>

Contact NAVSEA 04RM3 for information on commercial accreditation in accordance with 2.4 and 2.5 by NAVSEA approved commercial Accrediting Bodies (AB).

4.4 This item does not apply to Oxygen gauges.

4.5 Point of contact for Level 2 system or chain calibrations is NAVSEA 04RM.

4.6 Contact one of the following Navy Certification Activities for certification requirements in accordance with 2.6:

Mid-Atlantic Regional Maintenance Center  
Laboratory Certification Branch  
(Code 212)  
Phone: (757)400-0735  
FAX: (757)400-3160

Southwest Regional Maintenance Center  
Laboratory Certification Branch  
(Code 240C)  
Phone: (619)556-6699/(619)556-1346  
FAX: (619)556-4877

4.7 Scope: The official and detailed statement of the calibration services for which the laboratory is accredited. Alternative terms include scope of accreditation, scope of competency, and scope of calibration.

4.8 For boats and craft 65 feet or less in length gages and meters do not require calibration unless boat or class of boats has been issued a Calibration Requirement List (CRL) or required by 3-M or 3-M like system used as the Preventative Maintenance System (PMS) for the boat.

## ATTACHMENT A

- Entries in the calibration events file shall not be abbreviated.
- The event data for NOFORN/Reactor/Steam plant instruments shall be handled in accordance with the applicable SEA 08 directives.
- For existing, permanently installed instruments, the calibration events file data set shall include the nomenclature, CRL reference number, condition received (i.e., In Tolerance (IT) or Out of Tolerance (OOT)), date calibrated, date due, procedure used, calibration standard used, servicing lab code and service label applied (i.e., calibrated, special calibration, rejected, etc.) in accordance with 2.7.
- For existing, non-installed instruments, the calibration events file data set shall include the nomenclature, National Stock Number, Sub-Category (SCAT) Code, instrument serial number, manufacturer's Commercial and government Entity (CAGE), procedure used, calibration standard used, sub-custodian, work center. Manufacture's model number, condition received, Metrology Requirements List (METRL) cycle, servicing laboratory code (if applicable), date serviced, due date, and servicing label attached.
- For newly added instruments, the minimum data set includes manufacturer, model, serial number, nomenclature, manufacturer's CAGE, range, procedure used, calibration standard used, date calibrated, date due, servicing lab code, service label attached, location, part-of (System), function within the system (if permanently installed), National Stock Number and SCAT Code.

NAVSEA  
STANDARD ITEM

FY-24

ITEM NO: 009-15  
DATE: 25 OCT 2022  
CATEGORY: II

1. SCOPE:

1.1 Title: Rotating Machinery; balance

2. REFERENCES:

2.1 Standard Items

2.2 S9086-G9-STM-010/CH-231, Propulsion and SSTG Steam Turbines

2.3 MIL-STD-167-1A, Mechanical Vibration of Shipboard Equipment (Type I-Environmental and Type II-Internally Excited)

2.4 S9245-AR-TSM-010/PROP, Marine Propeller Inspection, Repair and Certification

3. REQUIREMENTS:

3.1 Measure and record the maximum eccentricity of the rotor shaft and installed components relative to the points of support using dial indicators.

3.2 Balance rotating machinery assemblies or components in accordance with the following requirements and procedures:

3.2.1 Balance multistage steam turbine rotors in accordance with 2.2.

3.2.1.1 Contact the SUPERVISOR prior to directing balance work for multistage steam turbine rotors.

3.2.1.2 Multistage steam turbine rotors must only be balanced at high speed (operating speed), in accordance with Section 231-8.13 of 2.2. Balance work must be performed by the OEM, OEM certified equivalent, or NAVSEA approved contractor who has a proven capability to high speed balance rotors in accordance with 2.2, 2.3 and the OEM balance specification for the rotor.

3.2.1.3 No attempt must be made to straighten a turbine rotor assembly.

3.2.1.4 Steam turbine rotors must be balanced with the overspeed trip governor installed.

3.2.1.5 Post-repair testing (sea trials for propulsion units) for multistage steam turbines where turbine repairs have been accomplished, must include a bearing cap vibration survey.

3.2.1.6 Submit one legible copy, in hard copy or approved transferrable media, of an equipment overhaul report to the SUPERVISOR. Report must include a balance report in accordance with Section 231-8.13 of 2.2. Unsatisfactory vibration balance levels recorded in the post repair testing, as determined by the SUPERVISOR, will be corrected by in-place balancing in accordance with Section 231-8.13 of 2.2.

3.2.2 Except for propellers, if the design operating speed of the component to be balanced is less than 150 revolutions per minute (RPM), the rotor including shaft must be balanced by symmetrically supporting the rotor on 2 knife edges and applying a correction to attain a gravity balance.

3.2.3 Except for propellers, if the design operating speed of the component to be balanced is equal to or greater than 150 RPM, the rotor including shaft must be balanced with equipment which requires rotation of the work piece.

3.2.4 Propellers must be balanced in accordance with 2.4.

3.2.5 Types of correction:

TYPES OF CORRECTION	N 1/	ROTOR CHARACTERISTIC 1/
Single-plane	0 - 1,000	L/D Less than or Equal to 0.5
	0 - 150	L/D Greater than 0.5
2-plane	Greater than 1,000	L/D Less than or Equal to 0.5
	Greater than 150	L/D Greater than 0.5

TYPES OF CORRECTION	N 1/	ROTOR CHARACTERISTIC 1/
Multi-plane		Flexible: Unable to correct by 2-plane balancing

1/

- L = Length of rotor mass, exclusive of shaft
- D = Diameter of rotor mass, exclusive of shaft
- N = Maximum operating RPM

3.2.6 Allowable unbalance: The values determined by Paragraph 5.2.2.2 of 2.3 are permitted in each plane of correction, except for multistage steam turbine rotors which must be in accordance with Section 231-8.13 of 2.2.

3.2.7 When the computation for converting displacement measurements to ounce-inches of force unbalance is an approximation, verification must be made by adding a trial weight to the rotor, equal and opposite to the calculated ounce-inches of force. If putty is used as a trial weight, it must be removed, weighed and a permanent compensating weight must be installed in its place.

3.2.8 Accomplish vibration testing and analysis in accordance with NAVSEA Standard Items. (See 4.2)

3.3 Submit one legible copy, in approved transferrable media, of a report listing results of the requirements of 3.1 and 3.2 to the SUPERVISOR. The report must include the following information:

3.3.1 Ship's name and hull number

3.3.2 Contractor and subcontractor

3.3.3 Job Order and Work Item number

3.3.4 Unit and component identification

3.3.5 Manufacturer and model number of balance machine

3.3.6 Date of last calibration, by whom it was calibrated, and when the next calibration is due for the balancing machine

3.3.7 Maximum total indicated runout of rotor or balancing arbor

3.3.8 Weight of rotor assembly in pounds

3.3.9 Design operating RPM of rotor

3.3.10 Computation of allowable unbalance in ounce-inches

3.3.11 Measured unbalance, prior to and after balancing, in ounce-inches

3.3.12 Computations or procedures for converting displacement measurements to ounce-inches of unbalance force, when the machine used to balance components indicates displacement measurements in lieu of direct unbalance forces.

#### 4. NOTES:

4.1 For multistage steam turbine rotors only:

4.1.1 Prior to performing machine or in-place balance, SUPERVISOR must contact NAVSEA 05Z22.



4.1.2 SUPERVISOR must forward as-found/final balance result and shipboard vibration and analysis report to NAVSEA 05Z22 and NSWCPD Code 412.

4.2 If vibration testing and analysis is required, the use of Standard Item 009-104 “Machinery Vibration and Analysis; accomplish” of 2.1 will be specified in the Work Item.

NAVSEA  
STANDARD ITEM

FY-24

ITEM NO: 009-16  
DATE: 25 OCT 2022  
CATEGORY: II

1. SCOPE:

1.1 Title: Electronic Equipment; repair

2. REFERENCES:

2.1 Equipment Technical Manual

2.2 407-5291780, Standard Electromagnetic Interferences (EMI) Survey Procedures

2.3 SE000-01-IMB-010, Navy Installation and Maintenance Book (NIMB), Section VI, Electronics Installation and Maintenance Book - General Maintenance (Source CD: N0002400003)

2.4 SE000-01-IMB-010, Navy Installation and Maintenance Book (NIMB), Section IX, Installation Standards (Source CD: N0002400003)

2.5 S9300-A6-GYD-010, Electrical Workmanship Inspection Guide for Surface Ships and Submarines

2.6 IA PUB-5239-31, Information Assurance Shipboard Red/Black Installation Publication

2.7 CNSSAM TEMPEST/01-13, (U) RED/BLACK Installation Guidance

2.8 MIL-STD-1310, Shipboard Bonding, Grounding, and Other Techniques for Electromagnetic Compatibility, Electromagnetic Pulse (EMP) Mitigation, and Safety

3. REQUIREMENTS:

3.1 Disassemble equipment for cleaning, inspection, and repair, using 2.1 for guidance. Record and retain electrical hook-up data.

3.1.1 Accomplish visual inspection of components prior to cleaning to detect evidence of casualties and deteriorating conditions that may not be apparent after cleaning.

3.1.2 Clean equipment and remove foreign matter.

3.1.3 Dry equipment, removing moisture and cleaning solvents.

3.1.4 Inspect equipment for applicable electromagnetic interference (EMI) fixes using Shipboard Electromagnetic Compatibility Improvement Program (SEMCIP) Technical Assist Network (STAN) in accordance with 2.2. Record results.

3.2 Inspect and test electrical and mechanical components, assemblies, subassemblies, equipment enclosures, internal circuitry, and enclosure hardware to design characteristics and determine missing and defective components, circuitry, and enclosure hardware in accordance with 2.1. Record results.

3.2.1 Remove existing and install new electrical and mechanical components, assemblies, subassemblies, internal circuitry, and enclosure hardware in place of those identified to be defective; install new where missing. New material must conform to the requirements of 2.1.

3.2.1.1 Accomplish soldering, desoldering, and removal of components and circuitry in accordance with Section 4 of 2.3.

3.2.1.2 Accomplish miniature and microminiature repair of printed circuit boards in accordance with Sections 5 and 6 of 2.3.

3.2.1.3 Ensure new wiring conforms to MIL-DTL-16878. Wire size and color code must be in accordance with 2.1. Individual wires in harnesses and chassis wiring may be plain white conductors with conductor identification sleeving at each end, stenciled with indelible ink to indicate color coding.

3.3 Inspect braided wire shielding terminations for conformance to Paragraph 2-19.3 of 2.4.

3.3.1 Remove existing and install new grounding sheath connectors in place of those identified to be defective; install new where missing. Installation must be in accordance with Paragraph 2-14 of 2.4.

3.4 Inspect terminal board wire connections for termination with lugs conforming to SAE-AS7928 of each conductor at the terminal board connections.

3.4.1 Remove existing and install new lugs in place of those identified to be defective, using 2.5 for accept or reject criteria; install new where missing. New lugs must conform to SAE-AS7928.

3.5 Inspect for missing and defective conductor identification sleeving.

3.5.1 Remove existing and install new conductor identification sleeving in place of those identified to be defective, using 2.5 for accept or reject criteria; install new where missing.

New conductor identification sleeving must conform to SAE-AMS-DTL-23053, Class One, white, marked with indelible ink.

3.5.1.1 Mark conductor identification sleeving in accordance with 2.1.

3.6 Correct discrepancies identified in terminal board connections in accordance with 2.1 and as modified by applicable field changes identified on the field change accomplished plate.

3.7 Inspect existing cabling and cable harnesses between hinged parts and between chassis and parts which are subject to removal for slack to prevent breaking of individual wires by repeated flexing and for chafing protection.

3.7.1 Provide slack in accordance with Paragraph 2-15 of 2.4 to prevent breaking of individual wires.

3.7.2 Install new chafing protection in accordance with Paragraph 2-15 of 2.4.

3.8 Secure loose wiring harness clamps. Remove existing and install new plastic clamps where identified to be defective; install new where missing. Installation must be in accordance with Paragraph 2-15.3 of 2.4.

3.9 Submit one legible copy, in approved transferrable media, of a report listing inspection and test results of 3.1 and 3.2, to include the applicable EMI fixes not installed and EMI fixes that have been improperly installed, a list of discrepancies corrected, and a list of new components and wiring installed, to the SUPERVISOR.

3.10 Tie loose harness lacing in accordance with Paragraph 2-15.2 of 2.4.

3.11 Adjust relays and burnish contacts in exposed type relays and switches.

3.12 Remove high spots on pinion and gear teeth by stoning.

3.13 Adjust and align mechanical components in accordance with 2.1.

3.14 Assemble equipment, using 2.1 for guidance.

3.14.1 Tighten loose controls and hardware. Free-up binding in moving parts, controls, switches, chassis slides, and runners.

3.14.2 Lubricate equipment in accordance with 2.1.

3.14.3 Install heat-dissipating tube shields conforming to MIL-DTL-24251.

3.15 Bond and ground equipment in accordance with 2.6 through 2.8.

(V)(G) "OPERATIONAL TEST"

3.16 Energize the equipment; calibrate, adjust, and align to achieve optimum operational characteristics in accordance with 2.1.

3.17 Update field change accomplished plate to indicate completed field changes when the Work Item directs the installation of new field changes.

4. NOTES:

4.1 Equipment technical manual will be listed in the invoking Work Item.

4.2 Shipboard Electromagnetic Compatibility Improvement Program (SEMCIP) Technical Assist Network (STAN) referred to in 3.1.4 is available at <https://semcip.nswc.navy.mil/stan/modules/stan/default.asp> .

NAVSEA  
STANDARD ITEM

FY-24

ITEM NO: 009-17  
DATE: 25 OCT 2022  
CATEGORY: II

1. SCOPE:

1.1 Title: Rotating Electrical Equipment; repair

2. REFERENCES:

- 2.1 Standard Items
- 2.2 Equipment Technical Manual
- 2.3 S9086-DA-STM-010/CH-100, Hull Structures
- 2.4 S9086-KC-STM-010/CH-300, Electric Plant - General
- 2.5 S9086-KE-STM-010/CH-302, Electric Motors and Controllers
- 2.6 S9086-KN-STM-010/CH-310, Electric Power Generators and Conversion Equipment
- 2.7 S9086-HN-STM-010/CH-244, Propulsion Bearings and Seals
- 2.8 S6260-BJ-GTP-010, Electrical Machinery Repair, Electric Motor, Shop Procedures Manual
- 2.9 MIL-DTL-17060, Motors, Alternating Current, Integral-Horsepower, Shipboard Use
- 2.10 S9310-AC-HBK-010, Commutator/Slip Ring Maintenance Handbook
- 2.11 MIL-STD-1310, Shipboard Bonding, Grounding, and Other Techniques for Electromagnetic Compatibility, Electromagnetic Pulse (EMP) Mitigation, and Safety
- 2.12 407-5291780, Standard Electromagnetic Interference (EMI) Survey Procedures
- 2.13 T9070-A2-DPC-010/302-1, AC motor and controller application requirements

3. REQUIREMENTS:

3.1 Disconnect equipment mechanically and remove, including rotating components connected directly to the shaft, using 2.2 for guidance.

3.1.1 Accomplish the following prior to disconnecting: measure air gap readings; measure bearing clearances for sleeve bearing equipment only; measure alignment readings; inspect couplings for cracks, broken segments, wear, and misalignment in excess of tolerances specified in 2.2; measure shaft thrust and run out readings; identify associated cables/wiring and hook-up data. Record data in Attachment B-2 or equivalent form that contains the requirements of Attachment B-2.

3.1.2 Identify associated cables and wiring. Disconnect equipment mechanically, using 2.2 for guidance. Record list of accessories in Attachment B-2 or equivalent form that contains the requirements of Attachment B-2.

3.1.3 Remove entire vaneaxial and tubeaxial fan assemblies from the duct system and transport to the shop for repair.

3.2 Accomplish a structural inspection of each foundation in accordance with 2.3. Record data. Record data in Attachment B-2 or equivalent form that contains the requirements of Attachment B-2.

3.2.1 Accomplishment of cleaning and painting requirements for foundations of equipment must be in accordance with NAVSEA Standard Items (See 4.9).

3.3 Matchmark, disassemble, inspect, measure, and test the equipment removed in 3.1, using 2.2 and 2.4 through 2.8 for guidance.

3.3.1 Inspect and dimensionally measure end bells, frame, rabbet fits, shaft, sleeve and pedestal bearings, keyways, fan and running surfaces for wear, eccentricity, and other defects, using 2.2 for accept or reject criteria, and 2.7 for location and type of measurements to be taken. Record data in Attachment C or equivalent form that contains the requirements of Attachment C.

3.3.2 Accomplish a 500-volt megger insulation resistance test, using Paragraphs 300-3.2.2 through 300-3.2.3, 300-3.4.8, 300-3.4.11, and 300-5.3.7.1 of 2.4 for guidance. Record data in Attachment B-1 or equivalent form that contains the requirements of Attachment B-1.

3.3.2.1 Disconnect solid-state devices and ground temperature-sensing leads prior to measuring insulation resistance of windings.

3.3.3 Accomplish a phase resistance balance test of windings, using a Wheatstone or Kelvin bridge, or with an ohmmeter capable of resolving one milliohm (0.001 ohm). Record phase balance for multi-phase equipment, using Paragraph 5.21 of 2.8 and 3.6.1 of 2.9 for guidance. Record data.

3.3.4 Accomplish a voltage surge test in accordance with Paragraphs 300-3.5.4 through 300-3.5.5 of 2.4. Record data in Attachment B-1 or equivalent form that contains the requirements of Attachment B-1.

3.3.5 Accomplish a DC HI POT test in accordance with Paragraph 300-3.5.2 through 300-3.5.2.3.4 of 2.4. Added another sentence to paragraph.. Record data in Attachment B-1 or equivalent form that contains the requirements of Attachment B-1.

3.3.6 Accomplish a Polarization Index Test in accordance with Paragraph 300-3.4.12 of 2.4. Record data in Attachment B-1 or equivalent form that contains the requirements of Attachment B-1.

3.3.7 Measure resistance value of each winding temperature detector, heater, and heater strip using low voltage ohmmeter. Record data in Attachment B-1 or equivalent form that contains the requirements of Attachment B-1.

3.4 Clean, dry, and test the equipment and windings.

3.4.1 Clean in accordance with Paragraphs 300-4.5.1 through 300-4.5.5 of 2.4.

3.4.2 Dry by placing in an oven in accordance with Paragraph 300-5.3.2.3 of 2.4. Allow to cool to ambient temperature.

3.4.3 Repeat 3.3.2 and 3.3.5 tests. Record data in Attachment B-1 or equivalent form that contains the requirements of Attachment B-1.

3.4.4 Repeat cleaning, drying, and testing in 3.4.1 through 3.4.3 if DC HI POT test readings are questionable, or if insulation resistance readings (minimum of 500 Meg Ohms for motors with a VPI Sealed Insulation System) are not in accordance with the following: DC generators and motors (except propulsion and auxiliary generators for submarines) including exciters, Table 300-3-64 of 2.4; DC propulsion generators and motors and DC auxiliary generators for submarines, Table 300-3-7 of 2.4; AC generators and motors other than propulsion, Table 300-3-8 of 2.4; AC propulsion generators and motors, Table 300-3-9 of 2.4. Record data in Attachment B-1 or equivalent form that contains the requirements of Attachment B-1. (See 4.5)

3.4.5 Repeat 3.4.1 through 3.4.3 if satisfactory readings are not obtained after the second cleaning. Record data in Attachment B-1 or equivalent form that contains the requirements of Attachment B-1. (See 4.5)

3.4.6 Notify the SUPERVISOR if satisfactory readings are not obtained after a third cleaning.

3.4.7 Repeat 3.3.3 and 3.3.4 tests. Record data in Attachment B-1 or equivalent form that contains the requirements of Attachment B-1. (See 4.5)



3.5 Protect the windings and machined surfaces. Accomplishment of cleaning and painting requirements for equipment housing exterior, including fan(s) and interior and exterior of each end bell must be in accordance with NAVSEA Standard Items. (See 4.9)

3.6 Inspect and test non-wound rotors for loose or cracked bars, localized overheating, and rubbing in accordance with 2.8. Inspect wound rotors, slip ring leads, and armatures for insulation damage and burns/hot spots. Inspect for loose coils and slot wedges. Inspect slip rings and commutators for damage and for wear limits, using 2.2 for criteria. Inspect brush rigging for cracks, chips, worn areas, distortion, spring condition, and insulating material for cracks and arc paths. Inspect leads and terminal lugs for damage and defects. Identify and tag leads with aluminum wrap-around bands with metal stamped or embossed markings. Record data in Attachment B-1 or equivalent form that contains the requirements of Attachment B-1.

3.7 Select the proper insulating process based on winding insulation classifications and to meet state or local air pollution standards. Select varnish methods and material, using Paragraphs 300-4.5.8 through 300-4.5.8.2 of 2.4 for guidance. Maintain the varnish in accordance with Paragraphs 300-4.5.8.3 through 300-4.5.8.3.3 of 2.4 and the varnish manufacturer's instructions. Maintain a current revision of the varnish manufacturer's instructions on storage, maintenance, and use of the type of varnish to be applied. Maintain a record of varnish temperature, viscosity and, for solventless varnish, gel time tests. Tests must show varnish is within varnish manufacturer's recommendations and have been accomplished in the intervals specified by the varnish manufacturer. The record must also show that the varnish is being stored as recommended by the varnish manufacturer. (See 4.5)

3.8 Varnish and bake windings in accordance with Paragraphs 300-4.5.8.4 of 2.4 and the varnish manufacturer's instructions. Do not immerse the leads. Wipe surfaces that affect assembly, such as rabbit fits and mounting flanges, with a cloth moistened with a solvent after draining and before baking. Remove excess varnish run-off from surfaces that affect assembly after baking. Apply a thin coat of air-dry varnish to metal surfaces exposed by the removal process in accordance with Paragraph 300-4.5.8.5 and 300-4.5.8.6 of 2.4. (See 4.5)

3.9 Repeat tests described in 3.3.2 through 3.3.5. Record data in Attachment B-1 or equivalent form that contains the requirements of Attachment B-1. (See 4.5)

3.10 Accomplish an AC HI POT test in accordance with Paragraphs 300-3.5.3 through 300-3.5.3.2.9 of 2.4. Record data in Attachment B-1 or equivalent form that contains the requirements of Attachment B-1. (See 4.5)

3.11 Repeat measurements described in 3.3.7. Record data in Attachment B-1 or equivalent form that contains the requirements of Attachment B-1.

3.12 True the commutator or collector rings. Eccentricity must not exceed the requirements of 2.10. Resurface or machine each individual collector ring to the same exact diameter to allow symmetrical brush holder to ring clearance spacing. Ensure metal shavings are not permitted to contaminate the rotor or stator assembly. Each cut must not exceed 0.010 inch.

Finish thickness must not be less than design wear tolerance as shown in 2.2. Undercut the mica between the commutator bars with the edge of the mica not exceeding a depth of 5/64-inch below the bars. Chamfer the bar edges and remove rough surfaces in accordance with Paragraph 7-4.1.3 of 2.10. Burnish the commutator with a very fine commercial burnishing stone conforming to A-A-58052. Polish collector rings to a mirror finish.

3.13 Accomplishment of the balancing requirement for each rotating assembly must be in accordance with NAVSEA Standard Items. (See 4.8)

3.14 Disassemble the brush rigging. Remove foreign matter. Replace existing cadmium-plated parts with zinc in accordance with ASTM A 153. Recondition threads of plated parts. Assemble brush rigging.

3.15 Repair lightly scored areas of frame, end bells, and shaft by manual methods. Recondition threads and fit key to keyway. Visually inspect keyway for deformed, cracked or chipped edges or high spots. Verify that fit between key and key-seat sides has a minimum clearance of 0.002 inch or maximum interference of 0.0005 inch. High spots in keyway may be removed by machining or grinding. Do not unnecessarily repair any keyway; instead, use a step key up to a maximum of 0.010 inch oversize and, where possible, include a radius in step. If key tightness cannot be corrected with a step key, machine worn/damaged keyways to recommended over-sizes as follows: Maximum of 0.015 inch oversize for a 1/8-inch key and increasing oversize allowance of 0.010 inch for each 1/8-inch increase in key size up to a maximum of 0.075 inch. If key tightness cannot be corrected by keyway repair, replace part involved. Apply a thin coat of petrolatum to unpainted mating surfaces except for explosion-proof motors, which must have clean, dry mating surfaces.

3.16 Prepare and refinish equipment. Protect machine surfaces, windings, and nameplates from being painted or otherwise damaged.

3.16.1 Accomplishment of cleaning and painting requirements for housing, fan, and interior and exterior of each end bell must be in accordance with NAVSEA Standard Items (See 4.9).

3.17 Accomplish the following on equipment having other than sleeve-type bearings unless otherwise specified in the invoking Work Item, using 2.8 for guidance.

3.17.1 Install new bearings, seals, fittings, lock washers, and locknuts conforming to 2.2, using 2.7 and Chapter 6 of 2.8 for guidance, except as indicated in 3.17.1.1 (utilizing Attachment A for guidance).

3.17.1.1 Install Type 111, Class 8 (double seal), bearings in motors meeting the criteria identified in Chapter 6 of 2.8. Only double seal bearings identified in Chapter 6 of 2.8 are acceptable for use.

3.17.1.2 Install Type 111, Class 8 (double seal), bearings with a C3 (greater than normal) radial internal clearance, if not originally furnished or already

accomplished during previous repair, in place of the Type 111 bearing originally furnished, for vaneaxial and tubeaxial fan motors not meeting the criteria of Chapter 6 of 2.8. Install Type 120 bearings in vaneaxial and tubeaxial fan motors originally furnished with Type 120 bearings.

3.17.1.3 Install new label plates with the inscription "DO NOT LUBRICATE" on equipment using double seal bearings (Type 111, Class 8, or Type 120).

3.17.1.4 Install pipe plugs on all grease fills and drains, for equipment converted from re-lubricable bearings to double seal bearings.

3.17.1.5 Prepare a report that reflects the change in the maintenance requirements for the converted motor, for equipment converted from lubricated bearings to double seal bearings. Record data in Attachment B-1 or equivalent form that contains the requirements of Attachment B-1.

3.17.2 Lubricate bearings with grease conforming to MIL-PRF-24508 in accordance with Paragraphs 244-1.7.7.2 and 244-1.7.7.3 of 2.7, for equipment not using double seal bearings.

3.18 Assemble the equipment using 2.2 and 2.4 through 2.8 for guidance. Do not use materials containing silicone in the repair and assembly of equipment with commutator or collector rings. Install new gaskets on covers, inspection plates, and between the external connection box and the frame. Gaskets must conform to MIL-PRF-1149 unless otherwise specified in 2.2. Set brush holders not less than 1/16-inch or more than 1/8-inch from commutator or collector rings unless otherwise specified in 2.2; set in electrical neutral plane and stagger brushes for maximum coverage of the commutator, in accordance with Paragraph 300-4.7.7.1.10 of 2.4; center over the collector rings; ensure the brushes do not extend beyond the edge of the collector rings; install new brushes in accordance with 2.2; sand new brushes to fit curvature of the commutator or collector rings in accordance with Paragraph 6-3.5 through 6-3.5.4 of 2.10; ensure brushes have a surface contact of 100 percent and are not chipped, cracked, or broken; remove sand, carbon, and other foreign matter resulting from fitting new brushes; adjust spring tension of brushes in accordance with 2.2. Adjust air gap as specified in 2.2, plus or minus 10 percent. Rotate shaft by hand a minimum of 3 revolutions. Rubbing or binding of rotating assembly must not be allowed.

3.18.1 Install label plates conforming to MIL-DTL-15024 for those identified to be missing or damaged.

3.18.2 Install identification markers on wiring in the external connection box. Ensure markers must be aluminum wrap-around type with metal stamped or embossed markings.

3.18.3 Inspect equipment for applicable electromagnetic interference (EMI) fixes using Shipboard Electromagnetic Compatibility Improvement Program (SEMCIP) Technical Assistance Network (STAN) in accordance with 2.12. Record data in Attachment B-1 or equivalent form that contains the requirements of Attachment B-1.

3.19 Accomplish a no-load shop test of the motor for a minimum of one-half hour. Verify proper direction of rotation. After one-half hour, measure current and voltage in each phase, speed and bearing temperature rise measured on the equipment's exterior near each bearing. Record data in Attachment B-1 or equivalent form that contains the requirements of Attachment B-1.

3.20 Accomplish an operational test, of the assembled vaneaxial/tubeaxial fan for one hour after bearing and stator temperatures stabilize within one degree Celsius for 3 consecutive 15-minute intervals. Verify proper direction of rotation. Measure current, voltage, frame and bearing temperature rise and speed at 15-minute intervals. Bearing temperatures must not exceed 180 degrees Fahrenheit, unless otherwise specified in the invoking Work Item or equipment technical manual. Measure hot insulation resistances of winding to ground immediately upon completion of the operational shop test, using a 500-volt megger. Record data in Attachment B-1 or equivalent form that contains the requirements of Attachment B-1.

3.21 Submit one legible copy, in approved transferrable media, of a report listing results of the requirements of 3.3 through 3.3.7, 3.4.3, 3.4.4, 3.4.5, 3.4.7, 3.6, 3.9, through 3.11, 3.17.1.5, 3.18.3, 3.19 and 3.20 to the SUPERVISOR.

3.22 Install equipment. Install new gaskets conforming to MIL-PRF-900 on disturbed ventilation. Align in accordance with 2.2. Measure and record facial and peripheral coupling data. Install chocks, shims, shock mounts, sound damping pads, and other accessories. Connect electrical cables/wiring. Bond and ground equipment in accordance with 2.11, using new ground straps. Rotate shaft by hand a minimum of 3 revolutions. Rubbing or binding of rotating assembly must not be allowed. Measure the air gap and bearing clearance (sleeve bearing equipment only), insulation resistance (at 500 volts DC), and thrust. Record data in Attachment B-2 and C or equivalent form that contains the requirements of Attachment B-2 and C.

3.22.1 Accomplishment of pump and driver shaft alignment must be in accordance with NAVSEA Standard Items. (See 4.10)

(V)(G) "OPERATIONAL TEST"

3.23 Accomplish an operational test of the assembled equipment at full system capacity for one hour after bearing and stator temperatures stabilize within one degree Celsius for 3 consecutive 15-minute intervals, unless otherwise specified in the invoking Work Item. When temperatures do not stabilize in four hours, stop test and contact the SUPERVISOR. Verify proper direction of rotation. Verify/establish oxide film coating of the commutator/collector rings, using 2.10 for guidance. Measure current, voltage, frame and bearing temperature rise, and speed at 15-minute intervals. Frame and bearing temperature rise and speed is not required for vaneaxial and tubeaxial fan assemblies. Bearing temperatures must not exceed 180 degrees Fahrenheit, unless otherwise specified in the invoking Work Item or equipment technical Record data in Attachment B-2 or equivalent form that contains the requirements of Attachment B-2. (See NOTE 4.12)

3.23.1 Accomplish the requirements of 3.23 twice for 2 speed motors, once while operating at low speed, and once while operating at high speed. Record data in Attachment B-2 or equivalent form that contains the requirements of Attachment B-2.

3.23.2 Accomplish the requirements of 3.23 for limited duty motors, for a period of time equal to the duty cycle of the motor. For motors with a duty cycle equal to or less than 30 minutes, measure data every 10 minutes. Record data in Attachment B-2 or equivalent form that contains the requirements of Attachment B-2.

3.23.3 Measure hot insulation resistances of windings to ground immediately upon completion of test, using a 500-volt megger. Record data in Attachment B-2 or equivalent form that contains the requirements of Attachment B-2.

3.24 Submit one legible copy, in hard copy or approved transferrable media, of a report listing results of requirements and data recorded in 3.1.1, 3.1.2, 3.2, 3.22, and 3.23 through 3.23.3 to the SUPERVISOR.

#### 4. NOTES:

4.1 Equipment technical manual, Allowance Parts List (APL) (if applicable) and drawings will be listed in the invoking Work Item.

4.2 Shop test of generator will be addressed in the invoking Work Item.

4.3 The purpose of 3.4.4, 3.4.5, 3.4.7, 3.7, 3.8, 3.9, and 3.10 is to ensure the integrity of motors with a VPI Sealed Insulation System.

4.4 Utilize Attachment A for determination if the Navy's motor bearing conversion program for Extended-Life Double Seal (ELDS) ball bearings is permissible).

4.5 Not required for motors with a VPI Sealed Insulation System.

4.6 MIL-B-17931 (Bearings, Ball, Annular, for Quiet Operation) bearings are considered to be Long Lead Time (LLT) material. It is recommended these bearings be provided as Government Furnished Material (GFM).

4.7 Data received in 3.17.1.5 must be used by the SUPERVISOR for the purpose of initiating action ensuring shipboard databases such as the Equipment Guidance List (EGL) are updated to reflect the change in maintenance requirements for converted motors. Additionally, where APL changes are initiated to convert to ELDS bearings, a COSAL feedback report must be submitted, providing the NSN and part number for the ELDS bearing by the SUPERVISOR. Utilize the following website to initiate changes to Technical Manuals, APLs, etc.:  
<http://www.navy311.navy.mil>.

4.8 If balancing of rotating equipment of 3.13 is required; the use of Category II Standard Item 009-15 “Rotating Machinery; balance” of 2.1 will be specified in the Work Item.

4.9 If cleaning and painting of 3.2.1, 3.5, or 3.16.1 is required, the use of Category II Standard Item 009-32 “Cleaning and Painting Requirements; accomplish” of 2.1 will be specified in the Work Item.

4.10 If pump and driver shaft alignment of 3.22.1 is required, the use of Category II Standard Item 009-58 “Pump and Driver Shaft Alignment; accomplish” of 2.1 will be specified in the Work Item.

4.11 Shipboard Electromagnetic Compatibility Improvement Program (SEMCIP) Technical Assistance Network (STAN) referred to in 3.18.3 is available at <https://semcip.nswc.navy.mil/stan/modules/stan/default.asp> .

4.12 Checkpoints (V) (G) are required for only generators, motor-generator sets, and Service A motors identified in references 2.9 and 2.13.

## ATTACHMENT A

1. To reduce motor maintenance and repair costs, the NAVY has implemented a program that allows for the use of Extended Life Double Seal (ELDS) bearings.
2. LIMITATIONS: The ELDS program does NOT apply to motors that are under the cognizance of NAVSEA 08.
3. APLs for motors meeting the conversion criteria requirements have been modified to identify ELDS bearings. In these cases, the APL bearing criteria will override any specifications delineated in the equipment technical manual or the motor "Original Equipment Manufacturer (OEM)" drawings. If ELDS bearings are not indicated in an APL, the following motor criteria must meet the applicability specifications for motors to undergo conversion to ELDS bearings:
  - 3.a Motor must be installed on a surface ship and must NOT be under the cognizance of NAVSEA 08.
  - 3.b Commercial motors are not eligible. Motors must have been furnished to the NAVY in accordance with MIL-DTL-17060 (Motors, Alternating Current, Integral Horsepower, Shipboard use), MIL-M-17413 (Motors, Direct Current, Integral H.P., Naval Shipboard [NAVY]) or MIL-M-17059 (Motors, 60 Cycle, Alternating Current Fractional H.P. [Shipboard Use]).
  - 3.c Motors using one or more noise-quiet bearings per MIL-B-17931 (Bearings, Ball, Annular, For Quiet Operation) are NOT eligible for ELDS conversion.
  - 3.d Bearings originally furnished with the motor must be Type 111 bearings per FF-B-171. Motors are NOT to be considered as candidates for ELDS conversion in situations where the equipment technical manual and/or the OEM motor drawings originally specified FF-B-171 bearings but have notes indicating that replacement bearings are to be in accordance with MIL-B-17931 (Bearings, Ball, Annular, For Quiet Operation).
  - 3.e The use of ELDS bearings is limited to motors where the full load speed and the size of both bearings are as follows:
    1. Maximum bearing size 306 or 206 and full load rpm between 1,801 and 3,600 rpm.
    2. Maximum bearing size 313 or 213 and full load rpm between 1,201 and 1,800 rpm.
    3. Maximum bearing size 318 or 218 and full load rpm less than 1200 rpm.
4. The repair process using ELDS bearings includes the following requirements:
  - 4.a Only ELDS bearings, in accordance with the following table (Attachment A / Table 1), can be used. Other double seal bearings will not provide an acceptable bearing life.

Attachment A / Table 1

ELDS Bearings NSNs and Part Numbers

SIZE	P/N	NSN
201	6201-2RS1C3/GHY	3110-01-492-0221
202	6202-2RS1C3/GHY	3110-01-491-0233
203	6203-2RS1C3/GHY	3110-01-491-0234
204	6204-2RS1C3/GHY	3110-01-491-6636
205	6205-2RS1C3/GHY	3110-01-451-9166
206	6206-2RS1C3/GHY	3110-01-451-9165
207	6207-2RS1C3/GHY	3110-01-451-9164
208	6208-2RS1C3/GHY	3110-01-451-9170
209	6209-2RS1C3/GHY	3110-01-451-9252
210	6210-2RS1C3/GHY	3110-01-492-1831
211	6211-2RS1C3/GHY	3110-01-518-0937
303	6303-2RS1C3/GHY	3110-01-493-3750
304	6304-2RS1C3/GHY	3110-01-451-9153
305	6305-2RS1C3/GHY	3110-01-451-9158
306	6306-2RS1C3/GHY	3110-01-451-9159
607	6307-2RS1C3/GHY	3110-01-451-9161
308	6308-2RS1C3/GHY	3110-01-451-9167
309	6309-2RS1C3/GHY	3110-01-451-9168
310	6310-2RS1C3/GHY	3110-01-490-6683
311	6311-2RS1C3/GHY	3110-01-492-0223
312	6312-2RS1C3/GHY	3110-01-490-6848
313	6313-2RS1C3/GHY	3110-01-492-0191
314	6314-2RS1C3GHY	3110-01-492-0226
315	6315-2RS1C3/GHY	3110-01-494-0993
316	6316-2RS1C3/GHY	3110-01-492-0188
317	6317-2RS1C3/GHY	3110-01-492-0219
318	6318-2RS1C3/GHY	3110-01-493-3749

4.b Both bearings of each converted motor must be ELDS bearings.

4.c A label plate must be permanently attached to the motor indicating "Do Not Lubricate".

4.d Grease fills and drains, if present, must be fitted with a pipe plug, securely fastened. Fittings to accommodate grease guns must be replaced with pipe plugs."



ATTACHMENT B-1

Ship name:

Hull number:

Work item number:

Date:

Motor nameplate data.

Manufacture:

Amperage (AMP):

Model number:

Horsepower (HP):

NSN:

Revolutions per minute (RPM):

S/N:

Winding (WDG):

Frame:

Maximum ambient temperature (AMB):

Volt:

Insulation class:

Phase:

Duty:

Hertz (HZ):

Drawing number (DWG):

Field changes:

Additional nameplate data:

ATTACHMENT B-1

3.3.2 500-volt megger insulation resistance test.

Lead	Acceptance Criteria	Measured	SAT	UNSAT
	MΩ	MΩ		
	MΩ	MΩ		
	MΩ	MΩ		
Findings:				

3.3.3 Phase resistance balance test.

Phase	Acceptance Criteria	Measured	SAT	UNSAT
	Ω	Ω		
	Ω	Ω		
	Ω	Ω		
Findings:				

3.3.4 Voltage surge test.

Circuit Tested	Test Voltage	Error Ratio	SAT	UNSAT
	V	%		
	V	%		
	V	%		
Findings:				

3.3.5 DC HI POT test.

Circuit Tested	Test Voltage	Leakage Current	SAT	UNSAT
	V	uA		
	V	uA		
	V	uA		
Findings:				

3.3.6 Polarization Index Test.

Circuit Tested	One Minute	10 Minute	PI Ratio	SAT	UNSAT
	MΩ	MΩ			
	MΩ	MΩ			
	MΩ	MΩ			
Findings:					

ATTACHMENT B-1

3.3.7 Resistance value of each winding temperature detector, heater, and heater strip.

Circuit Tested	Acceptance Criteria	Measured	SAT	UNSAT
	$\Omega$	$\Omega$		
	$\Omega$	$\Omega$		
	$\Omega$	$\Omega$		
Findings:				

3.4.3 Post cleaning test.

- 500-volt megger insulation resistance test.

Lead	Acceptance Criteria	Measured	SAT	UNSAT
	$M\Omega$	$M\Omega$		
	$M\Omega$	$M\Omega$		
	$M\Omega$	$M\Omega$		
Findings:				

- Phase resistance balance test.

Phase	Acceptance Criteria	Measured	SAT	UNSAT
	$\Omega$	$\Omega$		
	$\Omega$	$\Omega$		
	$\Omega$	$\Omega$		
Findings:				

- Voltage surge test.

Circuit Tested	Test Voltage	Error Ratio	SAT	UNSAT
	V	%		
	V	%		
	V	%		
Findings:				

- DC HI POT test.

Circuit Tested	Test Voltage	Leakage Current	SAT	UNSAT
	V	uA		
	V	uA		
	V	uA		
Findings:				

ATTACHMENT B-1

3.4.4 Post second cleaning test.

- 500-volt megger insulation resistance test.

Lead	Acceptance Criteria	Measured	SAT	UNSAT
	MΩ	MΩ		
	MΩ	MΩ		
	MΩ	MΩ		
Findings:				

- Phase resistance balance test.

Phase	Acceptance Criteria	Measured	SAT	UNSAT
	Ω	Ω		
	Ω	Ω		
	Ω	Ω		
Findings:				

- Voltage surge test.

Circuit Tested	Test Voltage	Error Ratio	SAT	UNSAT
	V	%		
	V	%		
	V	%		
Findings:				

- DC HI POT test.

Circuit Tested	Test Voltage	Leakage Current	SAT	UNSAT
	V	uA		
	V	uA		
	V	uA		
Findings:				

ATTACHMENT B-1

3.4.5 Post third cleaning test.

- 500-volt megger insulation resistance test.

Lead	Acceptance Criteria	Measured	SAT	UNSAT
	MΩ	MΩ		
	MΩ	MΩ		
	MΩ	MΩ		
Findings:				

- Phase resistance balance test.

Phase	Acceptance Criteria	Measured	SAT	UNSAT
	Ω	Ω		
	Ω	Ω		
	Ω	Ω		
Findings:				

- Voltage surge test.

Circuit Tested	Test Voltage	Error Ratio	SAT	UNSAT
	V	%		
	V	%		
	V	%		
Findings:				

- DC HI POT test.

Circuit Tested	Test Voltage	Leakage Current	SAT	UNSAT
	V	uA		
	V	uA		
	V	uA		
Findings:				

ATTACHMENT B-1

3.4.7 Phase resistance balance and voltage surge test.

- Phase resistance balance test.

Phase	Acceptance Criteria	Measured	SAT	UNSAT
	$\Omega$	$\Omega$		
	$\Omega$	$\Omega$		
	$\Omega$	$\Omega$		
Findings:				

- Voltage surge test.

Circuit Tested	Test Voltage	Error Ratio	SAT	UNSAT
	V	%		
	V	%		
	V	%		
Findings:				

3.6 Inspection of motor internal components.

SAT	UNSAT
Findings:	

3.9 Post varnish and bake test.

- 500-volt megger insulation resistance test.

Lead	Acceptance Criteria	Measured	SAT	UNSAT
	$M\Omega$	$M\Omega$		
	$M\Omega$	$M\Omega$		
	$M\Omega$	$M\Omega$		
Findings:				

- Phase resistance balance test.

Phase	Acceptance Criteria	Measured	SAT	UNSAT
	$\Omega$	$\Omega$		
	$\Omega$	$\Omega$		
	$\Omega$	$\Omega$		
Findings:				

ATTACHMENT B-1

- Voltage surge test.

Circuit Tested	Test Voltage	Error Ratio	SAT	UNSAT
	V	%		
	V	%		
	V	%		
Findings:				

- DC HI POT test.

Circuit Tested	Test Voltage	Leakage Current	SAT	UNSAT
	V	uA		
	V	uA		
	V	uA		
Findings:				

3.10 AC HI POT test.

Circuit Tested	Test Voltage	Leakage Current	SAT	UNSAT
	V	mA		
	V	mA		
	V	mA		
Findings:				

3.11 Post varnish and bake resistance value of each winding temperature detector, heater, and heater strip.

Circuit Tested	Acceptance Criteria	Measured	SAT	UNSAT
	$\Omega$	$\Omega$		
	$\Omega$	$\Omega$		
	$\Omega$	$\Omega$		
Findings:				

3.17.1.5 Maintenance requirement change for double seal bearing conversion.

Findings:				

ATTACHMENT B-1

3.18.3 Inspection for EMI fixes.

Findings:	

3.19 No-load shop test.

Direction of Rotation	CW		CCW	
Speed				RPM
Current			Volts	
T1	A	T1	V	
T2	A	T2	V	
T3	A	T3	V	
Bearing Temperature				
Coupled End				°F
Free End				°F

3.20 Operational shop test of assembled vaneaxial/tubeaxial fan.

Direction of Rotation	CW		CCW	
Speed				RPM
Current			Volts	
T1	A	T1	V	
T2	A	T2	V	
T3	A	T3	V	
Bearing Temperature				
Coupled End				°F
Free End				°F
500-volt megger insulation resistance test				
Lead	Acceptance Criteria	Measured	SAT	UNSAT
	MΩ	MΩ		
	MΩ	MΩ		
	MΩ	MΩ		



ATTACHMENT B-2

Ship name:

Hull number:

Work item number:

Date:

Motor nameplate data.

Manufacture:

Amperage (AMP):

Model number:

Horsepower (HP):

NSN:

Revolutions per minute (RPM):

S/N:

Winding (WDG):

Frame:

Maximum ambient temperature (AMB):

Volt:

Insulation class:

Phase:

Duty:

Hertz (HZ):

Drawing number (DWG):

Field changes:

Additional nameplate data:

ATTACHMENT B-2

3.1.1 Preliminary inspection.

SAT		UNSAT	
Findings:			

3.1.2 List of accessories.

Findings:	

3.2 Foundation structural inspection.

SAT		UNSAT	
Findings:			

3.22 Post installation 500-volt megger insulation resistance test.

Lead	Acceptance Criteria	Measured	SAT	UNSAT
	MΩ	MΩ		
	MΩ	MΩ		
	MΩ	MΩ		
Findings:				

ATTACHMENT B-2

3.23 Operational test of the assembled equipment at full system capacity.

Direction of Rotation	CW		CCW	
Speed				RPM
15 Minutes				
Current			Volts	
T1	A	T1		V
T2	A	T2		V
T3	A	T3		V
Bearing Temperature				
Coupled End				°F
Free End				°F
30 Minutes				
Current			Volts	
T1	A	T1		V
T2	A	T2		V
T3	A	T3		V
Bearing Temperature				
Coupled End				°F
Free End				°F
45 Minutes				
Current			Volts	
T1	A	T1		V
T2	A	T2		V
T3	A	T3		V
Bearing Temperature				
Coupled End				°F
Free End				°F
One Hour				
Current			Volts	
T1	A	T1		V
T2	A	T2		V
T3	A	T3		V
Bearing Temperature				
Coupled End				°F
Free End				°F

ATTACHMENT B-2

3.23.1 Operational test of the assembled equipment at full system capacity, two speed motor.

Direction of Rotation	CW		CCW	
Speed	RPM			
15 Minutes				
Current		Volts		
T4	A	T4		V
T5	A	T5		V
T6	A	T6		V
Bearing Temperature				
Coupled End				°F
Free End				°F
30 Minutes				
Current		Volts		
T4	A	T4		V
T5	A	T5		V
T9	A	T6		V
Bearing Temperature				
Coupled End				°F
Free End				°F
45 Minutes				
Current		Volts		
T4	A	T4		V
T5	A	T5		V
T6	A	T6		V
Bearing Temperature				
Coupled End				°F
Free End				°F
One Hour				
Current		Volts		
T4	A	T4		V
T5	A	T5		V
T6	A	T6		V
Bearing Temperature				
Coupled End				°F
Free End				°F

ATTACHMENT B-2

3.23.2 Operational test of the assembled equipment at full system capacity, limited duty motor.

Direction of Rotation	CW		CCW	
Speed	RPM			
Duty Cycle or 10 Minutes as applicable.				
Current		Volts		
T1	A	T1	V	
T2	A	T2	V	
T3	A	T3	V	
Bearing Temperature				
Coupled End	°F			
Free End	°F			
20 Minutes as applicable.				
Current		Volts		
T1	A	T1	V	
T2	A	T2	V	
T3	A	T3	V	
Bearing Temperature				
Coupled End	°F			
Free End	°F			
30 Minutes as applicable.				
Current		Volts		
T1	A	T1	V	
T2	A	T2	V	
T3	A	T3	V	
Bearing Temperature				
Coupled End	°F			
Free End	°F			

3.23.3 Post installation 500-volt megger hot insulation resistance test.

Lead	Acceptance Criteria	Measured	SAT	UNSAT
	MΩ	MΩ		
	MΩ	MΩ		
	MΩ	MΩ		
Findings:				

ATTACHMENT C

SHIP NAME & HULL NUMBER

/ /  
MONTH/DAY/YEAR

MOTOR LOCATION (i.e., NO.2 MAIN FEED PUMP, etc.)

HOUSING DIAMETERS

<u>DRIVE END</u>			
	<u>A</u>	<u>B</u>	<u>C</u>
<u>1</u>			
<u>2</u>			
<u>3</u>			

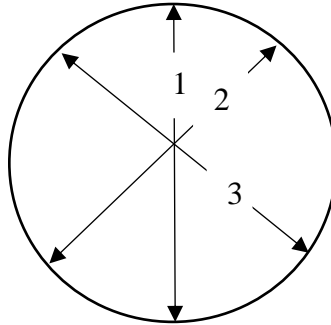

OUTER INNER

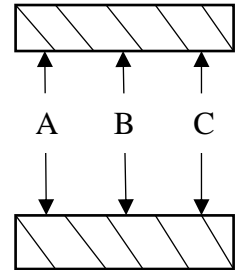

<u>OUTER END</u>			
	<u>A</u>	<u>B</u>	<u>C</u>
<u>1</u>			
<u>2</u>			
<u>3</u>			

SHAFT DIAMETERS

	<u>DRIVE END</u>			<u>OUTER END</u>		
	<u>A</u>	<u>B</u>	<u>C</u>	<u>A</u>	<u>B</u>	<u>C</u>
1						
2						
3						

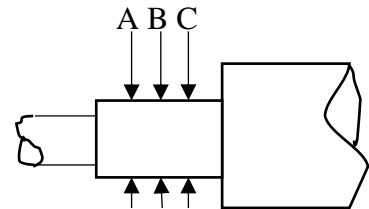
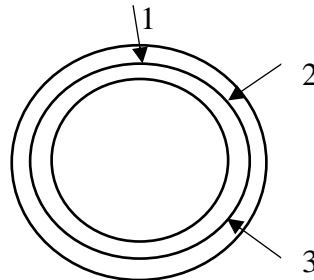

A. SHAFT RADIAL RUNOUT \_\_\_\_\_

B. FACE RUNOUT, BEARING INNER RING

DRIVE END \_\_\_\_\_

OUTER END \_\_\_\_\_

C. FACE RUNOUT, BEARING OUTER RING \_\_\_\_\_

DRIVE END \_\_\_\_\_

OUTER END \_\_\_\_\_

MECHANICAL CONDITION  
(LOSS OF LUBE, BURNED ETC.)

\_\_\_\_\_  
\_\_\_\_\_

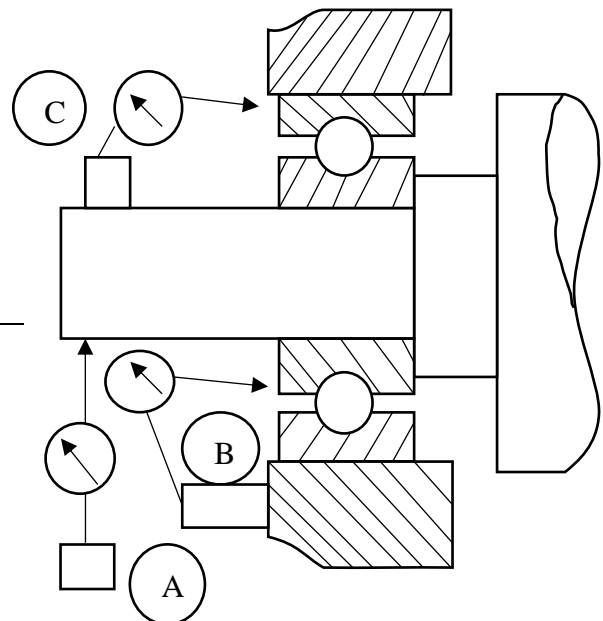

NAVSEA  
STANDARD ITEM

FY-24

ITEM NO: 009-18  
DATE: 25 OCT 2022  
CATEGORY: I

1. SCOPE:

1.1 Title: Mine Warfare Ships Magnetic Material; control

2. REFERENCES:

2.1 801-6134737, Location of Magnetic Material MCM-3

2.2 800-6135526, Location of Magnetic Material MCM-4

2.3 801-6356761, Location of Magnetic Material MCM-6

2.4 800-6787960, Location of Magnetic Material MCM-7

2.5 801-6356761, Location of Magnetic Material MCM-8

2.6 801-6645302, Location of Magnetic Material MCM-9 thru 14

2.7 524-7048237, IF Engine Emergency Cutout Valve

2.8 S9086-CJ-STM-010/CH-075, Fasteners

2.9 508-6644926, Insulation and Lagging Schedule, Pipe and Machinery

3. REQUIREMENTS:

3.1 Provide and implement a procedure for maintaining a maximum permeability factor of 2.0 on board mine warfare ships and craft for material and equipment installed, repaired, or relocated during the accomplishment of work required by the Job Order. The procedure must have been reviewed and accepted by the SUPERVISOR prior to the implementation.

3.1.1 The procedure requires a one-time submittal/acceptance unless Standard Items and/or references change or are updated.

3.1.2 Describe a receipt inspection system to verify Government, contractor, and subcontractor furnished material is in compliance with the permeability limits.

3.1.3 Describe controls used in fabrication work to ensure compliance with the permeability limits after fabrication.

3.1.4 Describe the method used to determine magnetic content of materials removed from or brought on board the ship or craft including monitoring station locations.

3.1.5 Identify type of instrumentation, conforming to Method 3 of ASTM A 342, used to measure the magnetic permeability of material.

3.1.6 Describe the record and reporting system utilized to list material required, but determined to have exceeded the permeability factor 2.0 after fabrication and the maximum dimension of the part exceeds 2 inches or the maximum dimension of all parts having a similar function in a 30 foot section of the ship exceeds 60 inches. This list must include material and equipment removed, repaired, installed, or relocated. The record and reporting system must contain description, magnetic dimensions, approximate weight, location installed on board ship or craft, and a record verifying that the item is contained in the current Location of Magnetic Material electronic database, a new database entry made for previously NAVSEA-approved items missing an entry or both a new entry made and waiver granted for new items or substitutions. Use 2.1 thru 2.6 as applicable, and the electronic database to determine if the 60 inches in 30 foot rule above is met.

3.2 Maintain or reduce permeability of items at or below 2.0, including proposing alternative materials for existing designs to the SUPERVISOR. Where alternatives are not possible or practical, submit one legible copy, in approved transferrable media, of a report in the format of Attachment A, to document repaired or replaced items in excess of the magnetic material control limit of 3.1.6. Ensure the part number, permeability range, and magnitude and location match component material and design. Equipment which is magnetic and not currently authorized by applicable NAVSEA drawing or technical manual (i.e., substitution or new item) additionally requires evaluation and acceptance by the SUPERVISOR prior to installation.

3.3 Verify the following attributes on all installed magnetic material, whether in accordance with current design or not, to minimize magnetic signature.

3.3.1 Vendor or stock number matches or crosses to NAVSEA document, if per current design.

3.3.2 Magnetic field location is limited to areas appropriate to the component (e.g., solenoids).

3.3.3 Magnetic permeability is appropriate for the specified material. Measured permeability will be affected by material, geometry, location temperature and degree of magnetization.

3.3.4 400 Series Monel and 304 CRES can be weakly magnetized by machining or welding; permeability must be less than 5 in accordance with Note 3.07 of 2.7.

3.3.5 Material Upgrades: Technical documentation may be used in lieu of surveys for identification for items that could become magnetic even if not when installed.

3.3.5.1 Upgrade low energy, non-safety critical system fasteners which are magnetic or potentially so, such as carbon steel, 304 CRES and 400 Series Monel to 500 Series Monel or 316L CRES as appropriate for the working environment. Replacement fasteners must be of identical thread size, type, shape and fit.

3.3.5.2 Submit one legible copy, in approved transferrable media, of a list of all proposed replacement fasteners with costs and sizes to the SUPERVISOR for approval prior to procurement.

3.3.5.3 Upgrade mechanical wire which is magnetic or potentially so, such as carbon steel wire used for lagging pad installation in accordance with 2.8, to 500 Series



Monel or 316L CRES lockwire in accordance with Paragraph 5.5.1 of 2.9. Replacement wire must be of equivalent size.

3.3.5.4 Select 500 Series Monel or 316L CRES as appropriate for the working environment for items with material not specified in NAVSEA documentation, such as the lagging pad hooks and washers of 2.9.

3.3.5.5 Upgrade non-critical load bearing hardware which is magnetic or potentially magnetic, such as carbon steel, 304 CRES and 400 Series Monel hinges, hasps, latches, chair swivels, corner reinforcements, etc., to 500 Series Monel or 316L CRES as appropriate for the working environment.

3.3.5.6 Upgrade electrical fittings which are magnetic or potentially magnetic, such as carbon steel, 304 CRES and 400 Series Monel stuffing tube packing nuts, cover plates, knockout plugs, etc., to 500 Series Monel, 316L CRES or Underwriter's Laboratory fire rated nylon or plastic as appropriate for the working environment.

3.3.6 Submit one legible copy, in approved transferrable media, of a report furnishing documentation provided by supplier, as required by 3.1.6.

#### 4. NOTES:

4.1 The magnetic field of mine warfare ships and craft consists of the superposition of the magnetic field from 4 basic sources: ferrous field, eddy current field, ship service stray field, and minesweep generator stray field. The stray field sources are the electric currents in cables and wiring associated with the operation of the equipment of the ship or craft. The ferrous field and eddy current field sources are as follows:

4.1.1 Ferrous Field Source: The ferrous field sources are the items on or part of the ship or craft which use a material in their construction that exhibits a relative magnetic permeability different than 1.0, the relative magnetic permeability of air. Each ferrous field source acts like a bar magnet whose magnetic field depends upon the material's relative magnetic permeability, volume (not mass), and shape of the earth's magnetic field. At a point or location external to a ferrous field source, the magnetic field of this source is essentially the same whether the source is hollow (such as a block or pedestal). A material whose relative magnetic permeability is 2.0 or less is arbitrarily defined to be nonmagnetic when used in conjunction with mine warfare ships and craft; otherwise, the material is said to be magnetic. Whether the material of an item is classified magnetic or nonmagnetic, according to the above arbitrary definition, a change in relative magnetic permeability of the material will, in general, result in a change in the magnetic field associated with this item.

4.1.2 Eddy Current Field Source: The eddy current field sources are the items on or part of the ship or craft which use a material in their construction that exhibits an electrical conductivity. A material whose electrical conductivity is less than 10.0 percent of the electrical conductivity of copper ( $5.8 \times 10^5$ /cm at 20 degrees Centigrade) is arbitrarily defined to be nonconductive when used in conjunction with mine warfare ships and craft; otherwise, the material is said to be electrically conductive. Each eddy current field source acts like a generator when it oscillates in the earth's magnetic field due to the rolling and pitching of the ship or craft. The current in this source, resulting from the generator action, has associated with it a magnetic field - an eddy current field. The magnitude of this field is dependent upon the conductivity of the material, the size of the electrical path in the material, the cross-sectional area of the electrical path, and the orientation of the source with respect to the earth's magnetic field due to the rolling and pitching of the ship or craft.

4.1.3 If an item is both highly magnetic and electrically conductive, such as mild steel or steel, the ferrous field will mask out the eddy current field. If an electrically conductive item is located inside a highly magnetic enclosure, such as mild steel or steel, the enclosure will mask the magnetic effects of its contents and will appear as if it were a solid magnetic block.

4.2 The SUPERVISOR will provide written direction for accomplishment of one of the following prior to installation of temporarily removed existing or new material/equipment as a result of the deviation request.

4.2.1 Authorization for deviation request.

4.2.2 Identification and authorization of an acceptable Contractor Furnished Material (CFM) substitute material or equipment.

4.2.3 Receipt of an acceptable Government Furnished Material (GFM) substitute material or equipment.

4.2.4 Technical direction and information for manufacturing of acceptable material or equipment.

4.2.5 Other direction as determined acceptable by the ship class planning yard or higher authority.

ATTACHMENT A

MCM-xx					
Date Installed/Noted					
Magnetic Component					
Permeability Range					
System/ESWBS					
Compartment #					
Frame #					
Port or Starboard					
Location Description(distance from reference point)					
Material					
Size of Magnetic Portion					
Authorizing Document(s)(tech manual, DWG)					
Per plan (YES/NO)					
Data Recorder Name:					
Data Recorder Company					
Shipbuilding Specialist					
Work Item #					
IDR #					
PN					
NSN					
Comments					

NAVSEA  
STANDARD ITEM

FY-24

ITEM NO: 009-19  
DATE: 25 OCT 2022  
CATEGORY: I

1. SCOPE:

1.1 Title: Provisioning Technical Documentation (PTD); provide

2. REFERENCES:

2.1 9090-1500, Policies and Procedures Manual, Provisioning, Allowance, and Fitting Out Support (PAFOS), Chapter 4, Provisioning

2.2 Interactive Computer Aided Provisioning System (ICAPS)

3. REQUIREMENTS:

3.1 Provide Provisioning Technical Documentation (PTD) in accordance with 2.1, for all new and/or modified Contractor Furnished (CF), Allowance Parts List (APL) worthy, Hull, Mechanical, and Electrical (HM&E) and/or Electronics components. PTD must include a Provisioning Parts List (PPL) and Engineering Data for Provisioning (EDFP).

3.1.1 PPL must identify each part subject to failure/replacement, or required for maintenance of the component, and must include the following SAE GEIA-STD-0007 Data Product Deliverables (DPDs):

- 3.1.1.1 Provisioning Contract Control Number (PCCN)
- 3.1.1.2 Provisioning List Item Sequence Number (PLISN)
- 3.1.1.3 Indenture Code for non-electronic components
- 3.1.1.4 Reference Designation for electronic components
- 3.1.1.5 Commercial and Government Entity (CAGE) Code
- 3.1.1.6 Reference Number
- 3.1.1.7 Item Name
- 3.1.1.8 Quantity Per Assembly (QPA)
- 3.1.1.9 Quantity Per End Item (QPEI)
- 3.1.1.10 Unit of Issue (UI)
- 3.1.1.11 Unit of Issue Price (UI Price)

3.1.1.12 Component Identification Data (CID): Enter all available data

3.1.2 Ship Level Provisioning Parts List (SLPPL) must include items determined not to be APL worthy in accordance with Appendix G of 2.1, and must include the SAE GEIA-STD-0007 DPDs identified in 3.1.1.

3.1.3 Statements of Prior Submission (SPS) must be submitted in lieu of PTD, whenever PTD that meets the requirements of the contract has previously been furnished to the Government. An SPS certifies that all replacement parts are identical to those provided by the previously furnished PTD. The SPS must apply to the end item or to any component thereof and must include:

3.1.3.1 End item part number

3.1.3.2 Manufacturer's CAGE

3.1.3.3 Manufacturer's drawing number and revision

3.1.3.4 RIC (APL number)

3.1.3.5 Certification statement certifying that all replacement parts are identical to those identified by the APL or previously furnished PTD

3.1.4 If there are any changes to replacement parts, a PTD package (PPL and EDFP) that identifies the changes must be submitted in lieu of an SPS.

3.2 An EDFP must be provided with each PPL and SLPPL submittal. EDFP must be marked with Distribution Statements in accordance with DoD Directive 5230.24.

3.3 Provide a Contractor Furnished Material (CFM) report and a copy of the Purchase Order and receipt document for each procurement of equipment or components for which PTD or SPS is required. The report must include:

3.3.1 Contract number

3.3.2 Contractor's purchase order number

3.3.3 Description of material

3.3.4 Quantity ordered

3.3.5 Date scheduled to be ordered

3.3.6 Date ordered

3.3.7 Date required to meet production schedule

3.3.8 Proposed receipt date

3.3.9 A summary listing any problem areas

3.3.10 Date submitted to SUPERVISOR

- 3.3.11 Alteration number
- 3.3.12 Drawing and piece number
- 3.3.13 Manufacturer
- 3.3.14 Manufacturer's part number
- 3.3.15 Date received
- 3.3.16 Work Item number

3.3.17 Submit one legible copy, in approved transferrable media, of the CFM report to the SUPERVISOR no later than 30 days after the Job Order award, every 14 days up to availability start date, within 10 days after availability start date, then monthly thereafter to End of Availability (EOA).

3.4 Submit data for PPLs and SLPPLs via 2.2, or in accordance with the ICAPS compatible format identified in Appendix K of 2.1 to the SUPERVISOR. Submit SPSs in approved transferrable media (spreadsheet or document) to the SUPERVISOR within 20 days after the installation of the contractor's component or equipment.

#### 4. NOTES:

4.1 EDFP is required for all systems or equipment that are acquired for Navy use and for which PTD is being acquired. EDFP is the data acquired to support Line Material Item supportability analysis. It is the technical data that provides definitive identification of dimensional, material, mechanical, electrical, or other characteristics adequate for provisioning of the support items of the end article(s) on contract. EDFP consists of but is not limited to data such as specifications, standards, drawings, photographs, sketches and descriptions, and the necessary assembly and general arrangement drawings, schematics, drawings, schematic diagrams, wiring and cable diagrams, etc. This data is necessary for the assignment of Source, Maintenance, and Recoverability (SMR) codes to assignment of Item Management Codes, prevention of proliferation of identical items in the Government inventory, maintenance decisions, and item identification necessary in the assignment of a National Stock Number (NSN).

4.2 2.1 is available at:

<http://www.nslc.navy.mil/nslcprod/pafos.nsf>

4.3 2.2 is available for download from:

<https://nedcchrgw.dc3n.navy.mil>

4.4 PTD data submitted to the SUPERVISOR is forwarded to:

NSWCCD-SSES  
Attn: Code 9451  
5001 S. Broad St.  
Philadelphia, PA 19112-5083

4.5 PTD data for all Navy boats and craft submitted to the SUPERVISOR is forwarded to:

NSWCCD-Detachment Norfolk  
Attn: Code 836  
2600 Tarawa Ct. Suite 303  
Virginia Beach, VA 23459-3239

NAVSEA  
STANDARD ITEM

FY-24

ITEM NO: 009-20  
DATE: 25 OCT 2022  
CATEGORY: I

1. SCOPE:

1.1 Title: Government Property; control

2. REFERENCES:

2.1 Federal Acquisition Regulation (FAR) Part 45, Government Property

2.2 Defense FAR Supplement (DFARS) Part 245, Government Property

2.3 Federal Acquisition Regulation (FAR) 52.245-1, Government Property

3. REQUIREMENTS:

3.1 Provide and maintain a property control system for government property in accordance with 2.1 and 2.2. The property control system must include the following functional elements, modified by the additional requirements in the following paragraphs:

3.1.1 Property Management

3.1.2 Acquisition

3.1.3 Receiving

3.1.4 Identification

3.1.5 Records

3.1.6 Movement

3.1.7 Storage

3.1.8 Physical Inventories

3.1.9 Reports

3.1.10 Consumption

3.1.11 Utilization

3.1.12 Maintenance

3.1.13 Subcontractor Control



3.1.14 Disposition

3.1.15 Contract Property Close-out

3.2 Provide for receipt of Government Furnished Property (GFP) as follows:

3.2.1 Submit the names and signatures of persons authorized to receive and account for GFP to the SUPERVISOR.

3.2.2 Inspect GFP immediately upon receipt for possible shipping damage.

3.2.2.1 Note any damage on carrier's copy of the Government Bill of Lading and notify the SUPERVISOR.

3.2.2.2 Forward one signed copy of the Shipping Document (DD Form 1348-1 or DD Form 1149) and one copy of the Bill of Lading to the SUPERVISOR.

3.2.3 Inspect GFP within 30 days of receipt or no later than 5 days of required use, whichever comes first, performing an inspection of the contents of the items shipped to verify:

3.2.3.1 Identity/kind of the material: Verify the material within container, as well as P/N and/or NSN, meets the description provided on the shipping documentation and associated Work Item.

3.2.3.2 Count of material: Visually count all items and ensure it meets the quantity indicated on shipping documentation and associated Work Item.

3.2.3.3 Condition of the material: Perform visual verification of the physical appearance of material, ensuring the packaging and/or material is not damaged, which may result in a questionable or failed visual inspection.

3.2.4 Submit one legible copy, in approved transferrable media, of a report within 2 days after inspection to the SUPERVISOR listing product quality deficiencies, including the following:

3.2.4.1 Date discovered

3.2.4.2 National Stock Number (if applicable)

3.2.4.3 Nomenclature

3.2.4.4 Manufacturer

3.2.4.5 Manufacturer's Part Number/Identification Number

3.2.4.6 Contract Number

3.2.4.7 Item condition (new or overhauled/repaired)

3.2.4.8 A specific description of the defect(s), listing drawing or technical manual dimensions, required and actual

3.2.4.9 If material is defective due to mishandling, rust, or moisture

3.2.5 Notify the SUPERVISOR immediately upon discovery of loss, damage, destruction, or theft of Government property.

3.2.5.1 Submit one legible copy, in hard copy or approved transferrable media, of a report in accordance with 2.3 to the SUPERVISOR within 5 days of the discovery.

3.3 Maintain records for GFP, containing the following information:

3.3.1 Ship's name and hull number

3.3.2 Job Order and Work Item numbers

3.3.3 Date received

3.3.4 Shipping document or Bill of Lading number

3.3.5 Date issued

3.3.6 Unit price and quantity

3.4 Dispose of government property as follows:

3.4.1 Return material purchased from the Government under the Cash Sale (Bailment) procedure and not incorporated into the end product being procured under the contract, or consumed directly in the performance of such contract, to the Government at the contractor's expense in the same condition as received. Submit one legible copy, in approved transferrable media, of turn-in document (DD 1348-1) showing material returned for credit, to the SUPERVISOR.

3.4.2 Process material permanently removed from the ship for replacement, substitution, or elimination, whether serviceable or not, including equipment units, parts, and items determined by the SUPERVISOR to be of value to the Government as follows. A written certification must accompany the inventory schedule submitted to the SUPERVISOR for equipment that has been purged of fluorocarbon or halon materials.

3.4.2.1 Inventory, identify, and tag or otherwise mark such property. Identification must include ship's name and hull number, Job Order and Work Item numbers, part number/stock number, and item description.

3.4.2.2 Assemble equipment prior to delivery to the Government except as specifically directed in the Work Item.

3.4.2.3 Remove valves or drill holes in empty gas cylinders prior to delivery to the Government.

3.4.2.4 Remove the chemicals from firefighting bottles, remove valves/stems, triple rinse the bottle, and stencil the bottle "Triple Rinsed".

3.4.2.5 Clean each item to be disposed of free of grease and/or substances considered to be hazardous in nature prior to delivery to the Government.

3.4.2.6 Submit one legible copy, in hard copy or approved transferrable media, of the inventory to the SUPERVISOR. The inventory must be signed by the contractor's

representative and submitted when directed by the SUPERVISOR, or in any case, immediately following the completion of each Job Order.

3.5 Submit Final Termination of Inventory Report within 14 days after completion of availability.

4. NOTES:

4.1 None.

NAVSEA  
STANDARD ITEM

FY-24

ITEM NO: 009-21  
DATE: 25 OCT 2022  
CATEGORY: I

1. SCOPE:

1.1 Title: Alteration Verification, Logistics and Technical Data; provide

2. REFERENCES:

2.1 None.

3. REQUIREMENTS:

3.1 Accomplish reporting of alterations in accordance with the following:

3.1.1 Meet with the ship's Commanding Officer's designated representative when required by SUPERVISOR within one day after start of the availability. Accomplish required reporting for each alteration in accordance with Attachments A through C.

3.1.2 Meet with the Commanding Officer's designated representative when required by the SUPERVISOR throughout the availability.

3.1.3 Submit one legible copy, in approved transferrable media, of completed Attachments A through C to the SUPERVISOR for each alteration within 3 days after alteration completion.

3.2 Complete Attachment D for all Government Furnished Material (GFM) and Contractor Furnished Material (CFM) equipment or components installed or permanently removed. This applies to all configuration changes, including alterations and repairs not reported in accordance with 3.1.

3.2.1 Provide individual Attachment D forms for each piece of equipment or component, including contractor submission and SUPERVISOR receipt signatures.

3.2.2 Submit data required by Attachment D, in approved transferrable media (spreadsheet or word processing document), to the SUPERVISOR no later than 5 days after installation or removal of GFM and CFM equipment or components from shipboard system(s).

3.3 Submit all copies of technical manuals, Maintenance Index Pages (MIP), and Maintenance Requirements Cards (MRC) received with GFM and CFM equipment to the SUPERVISOR no later than 5 days after receipt of equipment.

3.4 Data received in 3.3 required for installation and testing will be provided to the contractor.

4. NOTES:

4.1 Alterations may include Ship Alterations (ShipAlts), Boat Alterations (BoatAlts), Ordnance Alterations (ORDALTs), Engineering Changes (ECs), Field Changes (FCs), Machinery Alterations (MACHALTs), Ship Change Document (SCD), Alteration Equivalent to Repair (AER), and other configuration changes authorized for accomplishment.

4.2 The requirements of this NAVSEA Standard Item will be accomplished by the activity installing the alteration.

4.3 The technical point of contact for the requirements contained in the NAVSEA Standard Item is the local Class Maintenance Team Logistician for the SUPERVISOR.

ATTACHMENT A

Exceptions to ILS Verification/Itemized Deliverables as Listed on ILS Certification

ALTERATION IDENTIFICATION: \_\_\_\_\_

(Type Hull-Class-Alteration Number)

SHIP: \_\_\_\_\_ ALTERATION ACCOMPLISHMENT DATE: \_\_\_\_\_  
(Hull No./Name) (From - To)

INSTALLING ACTIVITY: \_\_\_\_\_

1. The following ILS was not provided upon completion of this alteration:
  - a. Technical Manuals (listed by identification number and equipment application).
  - b. Spares Support (OBRP and MAMs) that are with/without RIC/PAL No./Interim Repair Parts (listed by Equipment/Nomenclature)
  - c. COSAL Updates (list documentation not onboard)
  - d. Test Equipment (listed by Equipment Nomenclature)
  - e. PMS Documentation (listed by Maintenance Index Pages (MIPs), Maintenance Requirements Card (MRC) Numbers)
  - f. Ship Selected Record Drawings (SSRD) Markups (list mark-ups not onboard)
  - g. Installation Drawings (list drawings not onboard)
  - h. Onboard Initial/Differences Training as listed on ILS cert.
2. The following information is provided for items indicated in paragraph (1):
  - a. Information on how and when this missing ILS was ordered (i.e. Requisition Number, Letter/Transmittal Number, etc.).
  - b. Information on the current status/estimated receipt date/reason for late arrival (if known) (i.e. out of stock, not developed, etc.).
  - c. Information on the anticipated method of transfer to the ship when received (i.e. transshipment, forwarding letter, to be accomplished by someone other than Naval Supervisory Authority (NSA)/Alteration Installation Team (AIT), etc.).

**ATTACHMENT B**  
**PHYSICAL CONFIGURATION AUDIT REPORT**

ALTERATION IDENT: \_\_\_\_\_  
(Type Hull-Class-Alteration Number)

SHIP: \_\_\_\_\_ ALTERATION ACCOMP DATE: \_\_\_\_\_  
(Hull No./ Name) (From - To)

INSTALLING ACTIVITY: \_\_\_\_\_

EQUIPMENT NOMENCLATURE \_\_\_\_\_

SERIAL NO.: \_\_\_\_\_

LOCATION: \_\_\_\_\_

EQUIPMENT DISPOSITION:

INSTALLED     REMOVED     MODIFIED

EIC NO.: \_\_\_\_\_

TECHNICAL MANUAL(S):  
(New/Revised/Copies)

\_\_\_\_\_  
\_\_\_\_\_

APL/AEL/PAL: \_\_\_\_\_

TEST EQUIPMENT: \_\_\_\_\_

\_\_\_\_\_  
\_\_\_\_\_

PMS DOCUMENTATION: \_\_\_\_\_ (MIP NO.)

REMARKS: \_\_\_\_\_

\_\_\_\_\_  
\_\_\_\_\_

ATTACHMENT C

SHIP ALTERATION COMPLETION REPORT

REPORT NO: \_\_\_\_\_

ISSUE DATE: \_\_\_\_\_

SHIP/HULL: \_\_\_\_\_

SSP NO.: \_\_\_\_\_

UIC: \_\_\_\_\_

FY/TYPE AVAIL.: \_\_\_\_\_

NAVSEA SUMMARY

SHIPALT NO.	BRIEF DESCRIPTION	(Yes/No)	COMPLETE REMARKS
_____	_____	_____	_____
_____	_____	_____	_____
_____	_____	_____	_____
_____	_____	_____	_____

TYCOM SUMMARY

SHIPALT NO.	BRIEF DESCRIPTION	(Yes/No)	COMPLETE REMARKS
_____	_____	_____	_____
_____	_____	_____	_____
_____	_____	_____	_____
_____	_____	_____	_____
_____	_____	_____	_____



ATTACHMENT D

EQUIPMENT/COMPONENT LOGISTICS AND TECHNICAL DATA  
NAVSEA STANDARD ITEM 009-21  
INSTALLED/REMOVED DATE:

ALL DATA FIELDS ARE MANDATORY FILL. WRITE "NONE" WHERE NOT APPLICABLE.

SHIP NAME: \_\_\_\_\_ HULL: \_\_\_\_\_

SPEC PKG. NO.: \_\_\_\_\_ AUTHORITY (WORK ITEM): \_\_\_\_\_

ACTION: \_\_\_\_\_ RIC: \_\_\_\_\_

SHIP CHANGE DOCUMENT (SCD)/SHIPALT NO: \_\_\_\_\_

SERIAL NUMBER: \_\_\_\_\_

ITEM UNIQUE IDENTIFIER (IUID)/UNIQUE ITEM IDENTIFIER (UII): \_\_\_\_\_

VALVE MARK/ELECTRICAL SYMBOL NUMBER: \_\_\_\_\_

QUANTITY: \_\_\_\_\_ SHIPBOARD LOCATION: \_\_\_\_\_

RIC NOMENCLATURE: \_\_\_\_\_

TM(S) RECEIVED: \_\_\_\_\_

PMS MIP/MRC'S RECEIVED: \_\_\_\_\_

OBRP(S) RECEIVED: \_\_\_\_\_

INSTALLATION DRAWING NO: \_\_\_\_\_

RIC CHARACTERISTICS:

1. MFR \_\_\_\_\_

2. MFR DWG \_\_\_\_\_

3. MFR ID \_\_\_\_\_

4. NSN \_\_\_\_\_

CIRCLE ONE: GFM or CFM

COMMENTS: \_\_\_\_\_

\_\_\_\_\_

\_\_\_\_\_

REPORTING CONTRACTOR: \_\_\_\_\_

PRINTED NAME: \_\_\_\_\_

SIGNATURE: \_\_\_\_\_

RECEIVING SUPERVISOR: \_\_\_\_\_

PRINTED NAME: \_\_\_\_\_

SIGNATURE: \_\_\_\_\_

NAVSEA  
STANDARD ITEM

FY-24

ITEM NO: 009-23  
DATE: 25 OCT 2022  
CATEGORY: I

1. SCOPE:

1.1 Title: Interference; remove and install

2. REFERENCES:

2.1 Standard Items

2.2 0948-LP-045-7010, Material Control Standard

2.3 0924-LP-062-0010, Submarine Safety (SUBSAFE) Requirements Manual

2.4 S9086-KC-STM-010/CH-300, Electric Plant-General

2.5 NAVSEA OD32382, Grounding and Bonding Equipment Enclosures, Chassis and Cases, Design and Installation

2.6 S9086-RK-STM-010/CH-505, Piping Systems

2.7 803-8436636, Studs, Adhesively Mounted

3. REQUIREMENTS:

3.1 Do not remove components from the following systems as interferences, except when the scope of work requires repairs to components of these systems or when specified in the Work Item:

3.1.1 Main steam and catapult systems

3.1.2 Gaseous oxygen piping systems which operate at pressures higher than 100 PSIG, liquid oxygen piping from oxygen plant to the liquid oxygen charging carts, and the overboard drain piping from the liquid oxygen storage plant and spillage drain

3.1.3 Degaussing systems

3.1.4 Electric cables which cannot be removed without cutting

3.1.5 Hydraulic systems

3.1.6 High pressure air systems. High pressure air systems are those systems designed for pressures of 1,000 PSIG or greater.

3.1.7 Support systems (e.g., SCBA Charging and Swimmer and Diver support and protection systems, which supply breathable air.

3.1.8 Cryogenic systems

3.1.9 Spring hangers

3.1.10 Ship's strength members involving structural integrity

3.1.11 Halon systems

3.1.12 LEVEL I systems in accordance with 2.2

3.1.13 Sonar dome pressurization system

3.1.14 Passive countermeasure materials

3.1.15 Ballistic plating

3.1.16 Waveguides

3.1.17 Collective Protection System (CPS)

3.1.18 MRG Lube oil piping

3.1.19 Collection, Holding and Transfer (CHT)

3.1.20 Fiber Optic System (Cables)

3.1.21 For submarines and SUBSAFE capable ships only, in addition to the systems identified above, SUBSAFE components/systems in accordance with 2.3.

3.1.22 For nuclear-powered ships only, in addition to the systems identified above, steam plant systems that carry steam, water, or gas and which introduce these fluids either directly or indirectly into the steam generators, including:

3.1.22.1 Main Steam

3.1.22.2 Steam Generating

3.1.22.3 Feed

3.1.22.4 Condensate

3.1.22.5 Auxiliary Steam/Reduced Pressure Steam

3.1.22.6 Auxiliary Exhaust Steam

3.1.22.7 Gland Seal and Exhaust Steam

3.1.22.8 Bleed Steam

3.1.22.9 High Pressure Drain

- 3.1.22.10 Reserve Feed (except for reserve feed day tanks in surface ships)
- 3.1.22.11 Fresh Water Drain/Low Pressure Drain/Turbine Drain Catapult Steam Drain (up to catapult fill/charging valves and associated high-pressure drain system)
- 3.1.22.12 Catapult Trough Heating and Drain Systems
- 3.1.22.13 Main Steam Supply to reboiler and reboiler drains to the Deaerating Feed Tank (DFT)
- 3.1.22.14 Heating steam and condensate return piping to and from distilling units and lithium bromide air conditioners
- 3.1.22.15 Those portions of the propulsion plant makeup water distribution system downstream of the distiller output or reverse osmosis outlet demineralizer used to supply water directly or indirectly to the steam plant
- 3.1.22.16 Nitrogen supply system used for sparging of aircraft carrier steam generators
- 3.1.22.17 Reactor Plant Fresh Water System (RPFW), Propulsion Plant Fresh Water System (PPFW), and Steam Generator Cool down
- 3.1.22.18 Support systems (such as nitrogen systems, hydrostatic test rigs, and temporary steam generator makeup systems), which add water, steam, or gas directly or indirectly into steam generators
- 3.1.22.19 Any other systems or components governed by NAVSEA Instruction C 9210.4

3.2 Submit one legible copy, in approved transferrable media, of a report of components of the systems listed in 3.1 that must be removed as interferences and the work is not required by the Work Item, to the SUPERVISOR. The report must list the following information:

- 3.2.1 Identification of the item to be removed or disturbed:
  - 3.2.1.1 Location/Space
  - 3.2.1.2 Item description (e.g., piping size, valve number, cable identification, gauge number, etc)
  - 3.2.1.3 System
- 3.2.2 Necessity for the action
- 3.2.3 Protective measures which will be taken to protect equipment from damage or contamination
- 3.2.4 Alignment procedures and details for tests that will be accomplished to verify acceptability after installation.

3.3 Visually examine interferences prior to and during removal for previous damage and deterioration.

3.3.1 Submit one legible copy, in approved transferrable media, of a report listing previously damaged and deteriorated interferences to the SUPERVISOR within 5 days after removal.

3.4 Remove interferences.

3.4.1 Protect interferences from damage or loss and prevent contamination of removed components and remaining parts of the system.

3.4.2 Submit one legible copy, in approved transferrable media, of a report listing interferences removed to the SUPERVISOR within 5 days of removal. The report must identify and include the following information for each interference that was disturbed:

3.4.2.1 Location/Space

3.4.2.2 Item description (e.g., piping size, valve number cable identification, gauge number, etc)

3.4.2.3 System

3.4.3 When energized components (e.g., lights, receptacles, sensors) greater than 30 volts are removed for interference and a path to ground will no longer exist, a temporary ground must be installed before the component is disconnected from its permanent ground connection. Verify ground connection exists and that it is securely fastened with metal-to-metal contact in accordance with 2.4.

3.4.3.1 Components will be adequately secured to a permanent structure so that there is no tension/stress on cable/energy source.

3.5 Install interferences removed in 3.4.

3.5.1 Install interferences that were neither reported as previously damaged or deteriorated, nor rendered unsuitable for installation during removal.

3.5.2 Install interferences reported in 3.3.1 in the as-found condition or after authorized repairs have been accomplished.

3.5.3 Install new material in place of material rendered unsuitable for installation during removal or storage.

3.5.3.1 New material must be equal in composition, strength, design, type, and size as existed prior to removal of the interferences.

3.5.3.2 Ground and bond AEGIS combat systems equipment and related electrical equipment enclosures, chassis, and cases in accordance with 2.5.

3.5.4 Accomplish the requirements of 2.6 for system cleanliness.

3.5.5 Accomplish the requirements of 009-12 of 2.1.

3.5.6 Accomplish the requirements of 009-71 of 2.1 for disturbed joints.

3.5.6.1 Test pressure and test medium must be in accordance with 2.6.

3.5.7 Accomplish the requirements of 009-37 of 2.1.

3.5.8 Accomplish the requirements of 009-11 of 2.1.

3.5.8.1 Damaged reusable covers must not be installed.

3.5.8.2 Install new insulation, lagging, and reusable covers where missing.

3.5.9 Install new silicone coated aluminized cloth spray shields on mechanical joints and components in accordance with ASTM F 1138 in place of those removed as interference.

3.5.10 Install new gaskets and assemble in accordance with Section 5 of 2.6 when installing interferences.

3.5.11 Accomplish the requirements of 009-32 of 2.1 for each new and disturbed surface.

3.5.12 Restore compartment, equipment, and systems labeling.

3.5.13 Accomplish the requirements of 009-26 of 2.1 for deck covering removed or damaged as interference.

3.5.13.1 New material must be equal to existing in color and composition.

3.5.14 Accomplish the requirements of 009-25 of 2.1 for Disturbed Structural Boundary Test.

3.5.15 Accomplish the requirements of 2.7 for limited applications, subject to SUPERVISOR approval. When Adhesively Mounted Studs are used, each location of each stud and dates of installation must be documented for future maintenance.

3.5.15.1 Submit one legible copy, in approved transferrable media, of a report listing locations and dates of installation of Adhesively Mounted Studs installed to the SUPERVISOR. The report may be used for future maintenance.

(V)(G) "STRENGTH AND OPERATIONAL TESTS"

3.6 Align and accomplish appropriate strength, system cleanliness, and operational tests and ensure that the installed interferences perform their normal functions within the system.

3.6.1 Tests must be incorporated into the contractor's Test and Inspection Plan.

#### 4. NOTES:

4.1 An interference is any part of a ship, whether installed or portable, that must be moved or disturbed in the accomplishment of work specified in the Job Order.

NAVSEA  
STANDARD ITEM

FY-24

ITEM NO: 009-24

DATE: 25 OCT 2022

CATEGORY: I

1. SCOPE:

1.1 Title: Authorization, Control, Isolation, Blanking, Tagging, and Cleanliness; accomplish

2. REFERENCES:

2.1 Standard Items

2.2 Joint Fleet Maintenance Manual (JFMM)

2.3 9002-AK-CCM-010/6010, Industrial Ship Safety Manual for Submarines

2.4 S0400-AD-URM-010/TUM, Tag-Out User's Manual

2.5 29 CFR Part 1915, Occupational Safety and Health Standards for Shipyard Employment

2.6 S9AA0-AB-GOS-010, General Specifications for Overhaul of Surface Ships (GSO)

2.7 0902-018-2010, General Specifications for Deep Diving SSBN/SSN Submarines

2.8 S9086-RK-STM-010/CH-505, Piping Systems

2.9 845-4612172, Hydrostatic Test Blanks-Flanged & Welded

2.10 MIL-STD-777, Schedule of Piping, Valves, Fittings, and Associated Piping Components for Naval Surface Ships

2.11 S9074-AR-GIB-010/278, Requirements for Fabrication Welding and Inspection, and Casting Inspection and Repair for Machinery, Piping, and Pressure Vessels

3. REQUIREMENTS:

3.1 Accomplish the Work Authorization requirements of Volume IV, Chapter 10 of 2.2 for all non-nuclear work performed shipboard during Chief of Naval Operations (CNO) Availabilities, Continuous Maintenance Availabilities (CMAV), Window of Opportunity (WOO), or Emergent Maintenance (EM) Availabilities. Ensure all work on ship's systems and components is properly authorized and controlled in order to ensure rigorous personnel and ship safety standards are met. Include work such as planned maintenance, troubleshooting, corrective maintenance, and modernization and assessments.

3.1.1 Ensure all outside activity work (non-Ship's Force) on ship's systems and components, regardless of who performs the work, is formally authorized through a Work Authorization Form (WAF)



completed and processed in accordance with Volume IV, Chapter 10 (including Appendix A) of 2.2. A copy of the authorized WAF must be maintained at the worksite during productive work.

3.1.2 For submarines only, accomplish the Work Authorization requirements of Volume IV, Chapter 10 of 2.2 for safety of ship maintenance item identification, listing, and control, or the requirements of 2.3 for Ship's Plan of the Day (SPOD).

3.1.3 Maintain the WAF in the Work Authorization Log from the time of original authorization, through production work and testing, and until the WAF is formally closed out. When notified by the cognizant Repair Activity's (RA) designated representative that the work is complete and ready for tags to be cleared, the RA's designated representative will sign the WAF work completion block, then obtain ship's concurrence to clear the associated Tagout Record Sheet line item(s). Additional sign-offs required by the WAF for testing and closure must be made as work progresses in accordance with Volume IV, Chapter 10 of 2.2.

3.1.4 When a WAF Coordinator (WAFCOR) is required in accordance with 009-106 of 2.1, all repair activities participating in the availability must submit properly prepared WAFs to the Lead Maintenance Activity (LMA) WAFCOR for processing.

3.1.4.1 Train and qualify contractor's designated representative in the WAF process in accordance with 2.2. Maintain a current copy of the plan utilized to train and qualify contractor's designated representative in accordance with 2.2 for reference by the SUPERVISOR.

3.1.4.2 The Repair Activity (RA) responsible for the work must accomplish the requirements of 2.4 and complete blocks 1, 2, and 4 through 10 of the WAF and submit to the WAFCOR.

3.1.4.3 The WAFCOR must obtain the appropriate WAF serial number from the Ship's Force WAF Log and enter it into block 3 of the WAF. The WAFCOR must then submit the WAF to the ship's Watch/Duty Officer for processing blocks 11 through 14. The WAFCOR will sign block 12 for concurrence to start work.

3.1.4.4 The RA responsible for the work must sign Block 14 in conjunction with the Ship's Watch/Duty Officer.

3.1.4.5 The WAFCOR will issue a copy of the authorized WAF to the Repair Activity indicating authorization to begin work.

3.1.4.6 When work is complete, the RA will complete blocks 15 and 16 of the WAF in accordance with Volume IV, Chapter 10, Appendix A instructions of 2.2.

3.1.4.7 When testing is completed and recorded in accordance with 009-04 of 2.1, the WAFCOR must verify Block 16 has been signed by the RA responsible for the work and then sign Block 18 for the RA to allow closure of the WAF by the S/F Watch/Duty Officer. The S/F Watch/Duty Officer will be the final signature in Block 18 and officially closes the WAF. Operational testing associated with Dock Trials or Sea Trials, and controlled by formal test program, does not have to be complete prior to closing the WAF.

3.2 Accomplish the requirements of 2.4 for equipment, systems, circuits, components, tanks, voids, piping, and valves that require isolation.

3.2.1 Ensure the isolation, de-energization, drainage of the isolated area, and depressurization of mechanical, electrical, electronics, and pressure system has been accomplished.

3.2.2 Individuals who perform shipboard work must receive training on basic purpose, use and restrictions of 2.4. Maintain a current copy of the plan utilized to train individuals in accordance with 2.4 for reference by the SUPERVISOR.

3.3 Accomplish the requirements of the contractor's lockout/tags-plus program for unmanned craft and barges in accordance with 2.5.

3.3.1 Submit one legible copy, in hard copy or approved transferrable media, of contractor's lockout/tags-plus program to the SUPERVISOR when requested.

3.3.2 Position equipment to achieve required isolation, by de-energizing, draining of the isolated area, and depressurization, and use lockout/tags-plus program when lock-out of equipment, systems, circuits, components, piping, or valves is required in accordance with 2.5.

3.4 Post warning signs and barriers and install temporary positive means to prevent closure or movement of components that create a safety hazard at hull and deck openings.

3.5 Complete and maintain a written record by work item using Attachment A or equivalent contractor developed form that contains all the fields contained in attachment A (Accountability of Temporary Blanks and Plugs Check-Off Sheet), verifying installation and removal of temporary blanks/plugs used for Foreign Material Exclusion (FME), isolation of pressure boundaries, or hydrostatic testing. Location information must include the associated system/equipment name or tank number; frame, port or starboard, below or above water line. Serialization is required for temporary blanks used for isolation of pressure boundaries or hydrostatic testing.

3.5.1 Ensure the Accountability of Temporary Blanks and Plugs Check-Off Sheet (Attachment A) or equivalent contractor developed form that contains all the fields contained in attachment A is at all tank closings; ensure the removal of blanks/plugs in tanks are verified and documented via signature on the check-off sheet by Ship's Force representative and the SUPERVISOR prior to tank closing. Attachment A or equivalent contractor developed form that contains all the fields contained in attachment A must be retained with contractor's inspection records and made available to the SUPERVISOR upon request.

3.5.2 Maintain the Accountability of Temporary Blanks and Plugs Check-Off Sheet (Attachment A) or equivalent contractor developed form that contains all the fields contained in attachment A for the duration of the availability.

3.5.2.1 Maintaining the Accountability of Temporary Blanks and Plugs Check-Off Sheet (Attachment A) or equivalent contractor developed form that contains all the fields contained in attachment A, for material that has been removed from the ship is not required; however, that material must be entered in the Accountability of Temporary Blanks and Plugs Check-Off Sheet (Attachment A) or equivalent contractor developed form that contains all the fields contained in attachment A, when material is returned to the ship.

3.5.3 Verify all temporary blanks and plugs installed in the performance of work under each Work Item have been removed and documented on the Attachment A, or equivalent contractor developed form that contains all the fields contained in attachment A, associated with that Work Item.

3.5.3.1 Attachment A, or equivalent contractor developed form that contains all the fields contained in attachment A, must be retained with contractor's inspection records and made available to the SUPERVISOR upon request.

3.6 Install identification tags on each removed piping section, valve, ventilation system, and equipment to indicate company name, ship's name, hull number, system, location, and Work Item number prior to removal from system. Tags must endure the repair process, and must stay attached and be readable until the removed piping section, valve, ventilation system, or equipment is installed.

3.6.1 Include quantity when components are grouped/bagged/comingled together in a bucket or any other type of storage having only one identification tag.

3.6.2 Ensure FME is maintained on equipment removed from the ship.

3.7 Install and maintain blanks/plugs, nuts and bolts, painted white for use as FME immediately upon openings in equipment, valves, and piping systems not subject to pressure to prevent entry of foreign material and protect flanges and threaded areas. Existing system fasteners used for blanking that will be reused for installation are excluded from the requirement for white color. FME may be used for systems normally under pressure but are tagged-out for maintenance. The use of cloth, polyvinyl sheet, paper, tape, and rubber sheeting as FME is prohibited. All FME material must be applied with care, without using excessive force, to avoid damage to surfaces/components being protected.

3.7.1 Wood products, including damage control (DC) plugs are permitted for use as FME external to the ship for hull penetrations not in immediate vicinity of the flight deck. Wood products, including DC plugs, may be used as FME internal to the ship in piping and ventilation systems where permitted explicitly in the applicable Naval Ship's Technical Manual. DC plugs, wood, or wood products are prohibited for use in tanks/voids.

3.7.2 Piping, ventilation, and equipment components designated as scrap prior to removal do not need to be blanked to maintain cleanliness; however, they must be properly marked as scrap material prior to removal. Precautions must be taken to preclude spillage of system contents.

3.8 Maintain the cleanliness of new, modified, repaired and disturbed non-nuclear piping systems and components of nuclear and non-nuclear powered naval vessels in accordance with 2.6 through 2.8. Cleanliness levels must be as assigned in section 505j2 of 2.6.

3.8.1 Re-establishing local cleanliness status: Local cleaning is permitted in accordance with 505j4 of 2.6. If existing system cleanliness has been lost in a localized area (such as metal shavings deposited in a pipeline while removing a section for replacement), cleanliness condition can be re-established by locally swabbing, wiping, vacuuming, etc. the area to meet the cleanliness requirements of 505j2 of 2.6. Local cleaning is limited to piping sections which can be accessed directly and the results of cleaning fully observed without the aid of borescopes, mirrors or other devices.

(V) "VERIFY CLEANLINESS"

3.8.2 Verify that existing cleanliness was maintained.

3.8.3 Submit one legible copy, in approved transferrable media, of a report identifying any location where cleanliness has not been maintained in accordance with 3.8.1 and cannot be restored by local cleaning in accordance with 3.8.2. Include the cause of system contamination and recommended actions for cleanliness recovery. (See 4.2)

3.9 Install and maintain blanks/plugs, nuts and bolts, colored white that will be used for hydrostatic testing on equipment, valves, and piping systems in accordance with 2.9 to withstand maximum system pressure for systems which will serve as the primary or secondary barrier to support hydrostatic testing. Existing system fasteners used for blanking that will be reused for installation are excluded from the requirement for white color. Secure blanks in place with gaskets and fasteners in accordance with 2.10 or weld in place. Ensure welding requirements for blanks meet the same requirement as the piping welds, in accordance with 2.8, 2.11, and 009-12 of 2.1. The use of cloth, polyvinyl sheet, paper, tape, and rubber sheeting as blanks is prohibited. DC plugs, wood, or wood products are prohibited as blanks on pressurized systems, but may be used on non-pressurized systems to include gravity drain piping.

3.9.1 Ensure pressure blanks have a positive means of attachment for affixing tags. Tags must endure the repair process, and must stay attached and be readable until the blanks are removed. Include company/contractor name, Work Item number, WAF number, Contractor blanking/plugging log entry number, along with system/equipment/component name, number, and location.

3.10 Ensure blanks, plugs or cable end protection installed is removed and system/equipment is restored as soon as possible after completion of work. Ensure all tag-out requirements of 2.4 are followed.

#### 4. NOTES:

4.1 JFMM (2.2), 6010 (2.3), and TUM (2.4) are available on-line at:  
<https://www.submepp.csd.disa.mil/jfmm/index.htm>

4.2 FME is used to maintain system cleanliness. Accomplishment of NSI 009-107 of 2.1, or other means of cleanliness restoration, will be invoked within the Work Item when cleanliness is lost or suspected of being lost.

4.3 General piping system cleanliness is addressed in Section 505 of 2.6.

4.4 Cleaning requirements for specific systems are addressed in individual sections of 2.6 and 2.7.

4.5 The Lead Maintenance Activity (LMA) is defined in 2.2. MSRA/ABR contractors tasked with availability schedule management under 009-60/009-111 of 2.1 are considered the LMA.

4.6 MSRA/ABR contractors fulfilling the role of Lead Maintenance Activity under 2.2, or tasked with availability schedule managements under 009-60/009-111 of 2.1 are not “component contractors” and are responsible for the full scope of Repair Activity obligations under Volume IV, Chapter 10, of 2.2.

4.7 Worksite is defined as within the specific compartment or space where physical productive work is occurring. For tanks and voids, the WAF may be posted at the entry point of the space. For work performed on Navy boats and craft or service craft, the “work site” is defined as on or near the vessel.

ATTACHMENT A

ACCOUNTABILITY OF TEMPORARY BLANKS AND PLUGS CHECK-OFF SHEET

COMPANY NAME \_\_\_\_\_ HULL AND AVAILABILITY \_\_\_\_\_ WORK ITEM NUMBER \_\_\_\_\_

SYSTEM COMPONENT EQUIPMENT	LOCATION, TANK NUMBER	TYPE, SIZE,	SERIAL NUMBER	DATE INSTALLED	MECHANIC'S SIGNATURE	DATE REMOVED	MECHANIC'S SIGNATURE	SHIP'S FORCE REPRESENTATIVE SIGNATURE (Tanks Only)	SUPERVISOR SIGNATURE (Tanks Only)

NAVSEA  
STANDARD ITEM

FY-24

ITEM NO: 009-25  
DATE: 25 OCT 2022  
CATEGORY: II

1. SCOPE:

1.1 Title: Structural Boundary Test; accomplish

2. REFERENCES:

2.1 S9AA0-AB-GOS-010, General Specifications for Overhaul of Surface Ships (GSO), Chapter 192

2.2 S9086-RJ-STM-010/CH-504, Pressure, Temperature, and other Mechanical and Electromechanical Measuring Instruments

3. REQUIREMENTS:

3.1 Accomplish a completion air test of spaces in accordance with Section 192 of 2.1 and the following:

3.1.1 Install 2 independent pressure gauges. Each test gauge must conform to gauge range and graduation shown on 504-3.5.1 and 504-6.1.5 of 2.2.

3.1.2 Install 2 relief valves set at a maximum of 10 percent above test pressure.

3.1.3 Install one vent valve.

3.1.4 The air source must not exceed 25 PSIG and must have a supply capability less than the exhaust capability of either relief valve.

3.1.5 Pressurize the tank/void/space to be tested to the pressure specified in the invoking Work Item.

3.1.5.1 Isolate the pressure source and hold pressure for 15 minutes for temperature stabilization prior to commencing the pressure drop test.

3.1.5.2 Measure the pressure drop of the tested space for 10 minutes. Allowable pressure drop must be as specified in the invoking Work Item.

3.1.6 Accomplish unobstructed airflow test of air escape and overflow piping.

3.1.6.1 Accomplish unobstructed airflow test of air escape and overflow piping in accordance with Section 506h of 2.1.

3.1.7 Accomplish a visual inspection of disturbed mechanical joints for leakage upon completion of filling each tank. Allowable leakage: None.

3.1.8 Submit one legible copy, in approved transferrable media, reporting the results of the test listing the requirements of 3.1 through 3.1.7 to the SUPERVISOR.

3.2 Accomplish a running air test of spaces in accordance with Section 192 of 2.1, and the following:

3.2.1 Install 2 independent pressure gauges. Each test gauge must conform to gauge range and graduation shown on 504-3.5.1 and 504-6.1.5 of 2.2.

3.2.2 Install 2 relief valves set at a maximum of 10 percent above test pressure.

3.2.3 Install one vent valve.

3.2.4 The air source must not exceed 25 PSIG and must have a supply capability less than the exhaust capability of either relief valve.

3.2.5 Apply a soapy solution to the opposite side of the structure, associated tank piping, overflow and air escape piping, and inspect for leaks.

3.2.6 Inspect for leakage by observing for formation of bubbles. Allowable leakage: None.

3.2.7 Accomplish unobstructed airflow test of air escape and overflow piping.

3.2.7.1 Accomplish unobstructed airflow test of air escape and overflow piping in accordance with Section 506h of 2.1.

3.2.8 Accomplish a visual inspection of disturbed mechanical joints for leakage upon completion of filling each tank. Allowable leakage: None.

3.2.9 Submit one legible copy, in approved transferrable media, reporting the results of the test listing the requirements of 3.2 through 3.2.8 to the SUPERVISOR.

3.3 Accomplish a local air hose test in accordance with Section 192 of 2.1 and the following:

3.3.1 Air hose nozzle must be placed at less than 3 inches, but greater than zero inches, from the area to be tested and pressure directed at the structure under test in a manner most likely to disclose leaks.

3.3.1.1 The minimum nozzle diameter must be 3/8 inch and the nozzle pressure must be 90 plus or minus 5 PSIG as monitored at the nozzle.

3.3.2 Apply a soapy solution to the opposite side of the structure and inspect for leaks.

3.3.3 Inspect joint or fitting for leakage by observing for formation of bubbles. Allowable leakage: None.

3.3.4 Submit one legible copy, in approved transferrable media, reporting the results of the test listing the requirements of 3.3 through 3.3.3 to the SUPERVISOR.

3.4 Accomplish a water hose test in accordance with Section 192 of 2.1 and the following:

3.4.1 Use a one and one-half inch hose with a minimum nozzle diameter of one-half inch. Pressure at the nozzle must be no less than 50 PSIG at a maximum distance of 10 feet from the surface being tested.

3.4.2 The stream of water must be directed against the structure in a manner most likely to disclose leaks. The opposite side of the structure must be inspected to detect and locate leaks. Allowable leakage: None.

3.4.3 Submit one legible copy, in approved transferrable media, reporting the results of the test listing the requirements of 3.4 through 3.4.2 to the SUPERVISOR.

3.5 Accomplish a local vacuum box test in accordance with Section 192 of 2.1 and the following:

3.5.1 Apply a soapy solution to the structure being tested.

3.5.2 Install a vacuum box with a clear cover over each joint or each fitting being tested.

3.5.2.1 Install the vacuum box so that the pressure differential is in the direction of an air test.

3.5.3 Draw a vacuum of at least 10.2 inches of mercury and inspect for leaks.

3.5.3.1 Inspect the joint or fitting for leakage by observing through the clear cover for no formation of bubbles.

3.5.3.2 When the joint length exceeds the available vacuum box size, a minimum of 10 percent of the previous inspection area must be overlapped with the new inspection area when moved to adjacent inspection area.

3.5.4 Submit one legible copy, in approved transferrable media, reporting the results of the test listing the requirements of 3.5 through 3.5.3.2 to the SUPERVISOR.

3.6 Accomplish a cofferdam test in accordance with Section 192 of 2.1 and the following:

3.6.1 Install the cofferdam over the joint or fitting to be tested so that the pressure differential will be in the same direction of an air test.

3.6.2 Pressurize the air space inside the cofferdam to the test pressure specified for the air test.

3.6.3 Apply a soapy solution to the opposite side of the structure being tested.

3.6.4 Inspect the joint or fitting for leakage by observing for formation of bubbles. Allowable leakage: None.

3.6.5 If the opposite side of the structure is inaccessible, an alternate method of proving tightness is to measure the drop in pressure within the cofferdam over a 10 minute period. The gasket and fittings in the cofferdam should be checked for leakage using a soapy solution. Allowable drop in pressure: None.



3.6.6 Submit one legible copy, in approved transferrable media, reporting the results of the test listing the requirements of 3.6 through 3.6.5 to the SUPERVISOR.

3.7 Prior to strength or compartment test, accomplish a chalk test of each knife edge or mating surface and gasket on watertight doors, hatches, and scuttles.

3.7.1 Apply chalk to the bearing surface of the each knife edge or mating surface and close the door, hatch or scuttle by normal procedure.

3.7.2 When the door, hatch or scuttle is opened, the chalk from the each knife edge or mating surface must have been transferred to the gasket.

3.7.3 The chalk imprint must be in the center 3/5 of the width of the gasket with 100 percent continuous contact of knife edge to gasket. The chalk imprint for each structural closure with no knife edge must have 100 percent continuous contact of mating surface to gasket.

3.7.4 Submit one legible copy, in approved transferrable media, reporting the results of the test listing the requirements of 3.7 through 3.7.3 to the SUPERVISOR.

3.8 Repaired areas requiring a structural boundary test must remain uninsulated and unpainted until completion of successful inspection and test.

4. NOTES:

4.1 Associated tank piping is defined as, "An assembly of pipe, tubing, valves, fittings, and related components forming a whole or a part of a system which starts or terminates in subject area, thus being common to and associated with same."

NAVSEA  
STANDARD ITEM

FY-24

ITEM NO: 009-26  
DATE: 25 OCT 2022  
CATEGORY: II

1. SCOPE:

1.1 Title: Deck Covering; accomplish

2. REFERENCES:

2.1 Standard Items

2.2 MIL-STD-1623, Fire Performance Requirements and Approved Specifications for Interior Finish Materials and Furnishings (Naval Shipboard Use)

2.3 OPNAV 5100.19, Navy Safety and Occupational Health Program Manual for Forces Afloat

3. REQUIREMENTS:

3.1 All deck coverings materials specified herein must conform to the fire performance requirements of 2.2.

3.2 Maintain a current copy of the NAVSEA-reviewed Shipbuilders and Marine Paints and Coatings Product/Procedure Data Sheet (ASTM F718) for the NAVSEA-approved deck covering system specified in the invoking Work Item for reference by the SUPERVISOR. Where the ASTM F718 does not exist for a product, maintain a copy of the manufacturer's technical data sheets.

3.2.1 Submit one legible copy, in approved transferrable media, of specific documents when requested by the SUPERVISOR.

3.2.2 All deck covering materials that are qualified to performance specifications (MIL-PRF) are to be applied in accordance with the manufacturer's NAVSEA-reviewed ASTM F718 product data sheet. The dry film thickness (DFT), temperature, relative humidity, and surface preparation requirements stated herein take precedence over the NAVSEA-reviewed ASTM F718 data sheets if there is a conflict. The NAVSEA-reviewed ASTM F718 data sheets must supersede any other manufacturer's ASTM F718 data sheets for that product, even if it is newer (more recent) than the NAVSEA-reviewed ASTM F718 data sheets. Copies of the NAVSEA-reviewed ASTM F718 data sheets are available from the Naval Surface Treatment Center (NST Center) website: <http://www.nstcenter.biz>.

3.2.3 Comply with the NAVSEA-reviewed ASTM F718s, manufacturer's Safety Data Sheet (SDS) and/or manufacturer's instructions submitted in 3.2 for safety and health precautions during the removal, handling, and application of deck covering products.

3.2.3.1 Ensure that harmful vapors, fumes, and mists are ventilated to the exterior of the vessel.

3.3 Deck covering materials must be stored in a cool, dry place, not exposed to freezing temperatures or direct sunlight, and must be stored in accordance with NAVSEA-reviewed ASTM F718s and/or manufacturer's instructions.

3.4 Accomplish an unobstructed flow test of each deck drain, using clean fresh water prior to the disturbance of existing deck covering. Verify that all deck DC fittings are free, removable, and operational.

3.4.1 If any defects are identified in 3.4, submit one legible copy, in hard copy or approved transferrable media, of a report listing defects found to the SUPERVISOR.

3.4.2 Blank or plug each drain to prevent entry of contaminants.

3.5 Accomplish removal of the existing deck covering in its entirety (including base cove where installed) for locations requiring installation of a complete deck covering system.

3.5.1 Remove unused remnants, clips, brackets, and weldments from decks and vertical surfaces receiving new deck coverings.  
removals.

3.5.1.1 Chip and grind each surface flush and smooth in way of each removal.

3.6 Accomplish a visual inspection of each exposed piping penetration, deck drain, deck plating and bulkheads for structural integrity, deterioration, pitting, cracks, and areas of damage or distortion.

3.6.1 If any defects are identified in 3.6, submit one legible copy, in hard copy or approved transferrable media, of a report listing defects identified to the SUPERVISOR.

3.7 Accomplishment of cleaning and painting for each deck surface, including up the adjacent vertical surfaces intersecting the deck up to one inch above the complete deck covering system level must be in accordance with NAVSEA Standard Items (See Note 4.4). For components less than 1 inch from deck covering, the required surface preparation and primer application must be completed up vertical surfaces at the same height that the decking system will be installed.

3.7.1 If solvent is used to clean the deck at any point in the installation process, the deck must be allowed to dry before application of any coating. No visible solvent must be present on deck surfaces prior to proceeding with the next process step.

3.7.2 Where waterproof membranes are to be installed, the required surface preparation and primer application must be completed 5 inches up the adjacent vertical surfaces intersecting the deck. For components less than 5 inches from deck, the required surface preparation and primer application must be completed up vertical surfaces at the same height where waterproof membrane will be installed.

3.7.3 Decks receiving a MIL-PRF-3135 underlayment may also be primed using the primer or bond coat qualified as part of the deck covering system or with a coating conforming to MIL-DTL-24441, Type IV, Formula 150 at 4 to 6 mils or MIL-PRF-23236, Type V, VI, or VII, Class 5 or 7, at 4 to 8 mils DFT. No additional primer coating is required when the qualified bond coat is applied as part of the deck covering system.

3.7.4 Prior to the installation of MIL-PRF-3135, Type III or IV, underlayment, the surface preparation must be an SSPC-SP 3 substrate (i.e. direct-to-substrate without primer).

3.8 Accomplish a visual inspection of the exposed base coat or underlayment surfaces (after removing the top coats in accordance with the applicable Attachment) for a deck covering system repair that requires resurfacing or partial replacement and not a complete installation. (See 4.3)

### 3.9 Installation of deck coverings.

3.9.1 Install new rings and/or collars around each sounding tube and deck drain. New rings must be CRES Grade 316, 3/8-inch high by 3/16- inch thick and installed 1/4-inch peripherally to sounding tube or deck drain. Seal each ring and/or collar to the deck, using epoxy compound conforming to MIL-PRF-24176.

3.9.2 Install resin-based underlayment conforming to MIL-PRF-3135, Type III or IV, in way of low spots, dish pans, and high points that cannot be ground flush, to provide a smooth and fair surface. Slope and fair as required to ensure positive draining to deck drains where installed. See additional requirements in the applicable Attachment. Underlayment must be installed in accordance with NAVSEA-reviewed ASTM F718s and/or manufacturer's instructions and procedure submitted in 3.2 beneath the following deck covering materials: wear resistant deck tile, chemical- resistant floorings, solid vinyl tile, vinyl composition tile, porcelain tile, and quarry tile.

3.9.2.1 If the deck may cause a tripping hazard or promote premature failure of the deck covering (i.e. not level, high weld seams), a MIL-PRF-3135 underlayment may be installed beneath carpet and electrical sheeting/matting as directed by the SUPERVISOR.

3.9.3 Except where MIL-PRF-3135, Type IV underlayment is used, install a waterproof membrane in each wet space (as defined in Table 2) and in locations adjacent to wet space bulkheads where the coaming to deck joint is not 100 percent seam welded, and any other locations identified in the individual Work Item or as directed by the SUPERVISOR, where there is an increased likelihood of water penetration under the deck covering (e.g., around refrigerated vending machine foundations, AC spot cooler drains, spaces leading to the weather, etc.).

3.9.3.1 The membrane must be in accordance with ANSI A118.10, and be certified by the manufacturer to be compatible with both the underlayment and the installed deck

covering. The membrane must be one continuous barrier covering the entire deck, including the cove base 100 mm (4 inches) up each vertical surface. For components less than 4 inches from the deck, cove base is not required. Provide smooth sloped transition from the membrane to the components. Where the surface will be prepared and primed in accordance with 3.7 the membrane must be applied up to vertical surfaces at the same height of cove base where tiles will be installed.

3.9.3.2 The use of a waterproof membrane is not required in areas where MIL-PRF-32584, Types II or III products are used as specified in Table 2.

(I) "VISUAL INSPECTION"

3.9.3.3 Accomplish a visual inspection of the completely installed and cured waterproof membrane. The membrane must have a smooth, continuous surface that is free of air bubbles that penetrates any layer of the deck covering system. No embedded contaminants such as dust or fibers must be visible on the deck at 45 degrees to the surface when viewed using the as-installed ambient lighting source from a standing position.

3.9.4 Where the prevention of condensation on certain decks, e.g. above ballast tanks, or to reduce heat flow to decks located over hot machinery spaces, especially where these decks form the deck tops of living spaces, insulating deck covering material must be installed where designated by the SUPERVISOR. Install insulating deck covering material conforming to MIL-D-18873 or MIL-D-23134 in accordance with NAVSEA-reviewed ASTM F718s and/or manufacturer's instructions.

3.9.5 Accomplish the requirements of Attachment A for the installation of new unglazed porcelain tile deck covering system, using the NAVSEA-reviewed ASTM F718 and/or the manufacturer's instructions.

3.9.6 Accomplish the requirements of Attachment B for the installation of new wear resistant deck tile covering system, using the NAVSEA-reviewed ASTM F718 and/or the manufacturer's instructions.

3.9.7 Accomplish the requirements of Attachment C for the installation of new, or the resurface of existing, chemical-resistant flooring systems, using the NAVSEA-reviewed ASTM F718 and/or the manufacturer's instructions.

3.9.8 Accomplish the requirements of Attachment D for the installation of new electrical grade sheeting and matting deck covering system, using the NAVSEA-reviewed ASTM F718 and/or the manufacturer's instructions.

3.9.8.1 Electrical grade sheeting is a continuous deck covering acting as the primary deck covering system across the entire deck of a space.

3.9.8.2 Electrical grade matting is installed over the primary deck covering system in localized areas in way of electrical hazards.

3.9.9 Accomplish the requirements of Attachment E for the installation of new carpeting deck covering system, using the NAVSEA- reviewed ASTM F718 and/or the manufacturer's instructions.

3.9.10 Accomplish the requirements of Attachment F for the installation of new vinyl composition and solid vinyl tile deck covering systems, using the NAVSEA-reviewed ASTM F718 and/or the manufacturer's instructions.

3.9.11 Accomplish the installation of new light-weight concrete deck covering system, using the NAVSEA-reviewed ASTM F718 and/or the manufacturer's instructions.

3.9.12 Accomplishment of cleaning and painting for each MIL-PRF- 32584, Types I, II or III high durability deck coating and MIL-PRF-24667 nonskid applications must be in accordance with NAVSEA Standard Items (See Note 4.4).

3.9.12.1 Accomplish the requirements of Attachment G for the installation of new or replacement of MIL-PRF-24667, Type XI nonskid, using the NAVSEA-reviewed ASTM F718 and/or the manufacturer's instructions.

3.9.13 MIL-DTL-15562 matting is required in areas where specific electrical hazards may exist in non-designated electrical spaces as designated by the SUPERVISOR.

3.9.14 Newly installed deck covering systems must be allowed to stabilize at room temperature for 24 hours prior to foot traffic and must not be washed for 48 hours.

(I)(G) "VISUAL INSPECTION"

3.9.15 Accomplish a visual inspection of the completely installed and cured deck covering system. Ensure that each deck covering system is in accordance with Tables One and 2, and is uniform and free of defects. Deck coverings with a sealer coat installed must have a continuous surface, free of blotchy areas, pooling, ridge marks or runs, with only negligible embedded surface contaminants. Air bubbles in the seal coat are acceptable; however, they must not penetrate any other layers of the deck covering system. Imperfections that may cause premature failure or do not meet the above requirements must be corrected before the surfaces are accepted.

(I) "UNOBSTRUCTED FLOW TEST AND POSITIVE DRAINING INSPECTION"

3.9.15.1 Remove each blank and plug installed in 3.4.2 and accomplish an unobstructed flow test of each deck drain (where installed), using clean, fresh water. No obstruction allowed. For wet space decks, accomplish a positive draining inspection, using a sufficient amount of clean, fresh water throughout each deck surface to ensure that new deck covering system slopes to the drains. Water must flow to drains and not stand or puddle.

3.9.15.2 Upon completion of deck covering installation, verify all deck DC fittings are free, removable, and operational. Ensure deck drain covers, remote operating gear deck box covers, and other DC fittings have not been sealed over during the installation of sealer coats and/or deck covering installation are removable and operational.

#### 4. NOTES:

4.1 Table One provides the deck covering systems for dry interior spaces. Table 2 provides the deck covering systems for wet interior spaces. Wet interior spaces are defined as interior compartments that are exposed to wet conditions or potential immersion resulting from equipment in space, exposure to weather, or other service conditions of the space. Column A lists the approved decking materials for each group of spaces. Column B lists where electrical grade sheeting or matting, MIL-DTL-15562, must be used for non-designated electrical spaces where electrical hazards may exist in accordance with 3.9.13. Column C lists where nonskid must be used in working areas around machinery and walking areas in accordance with 3.9.12.

4.2 The SUPERVISOR will select type, color, and pattern of deck coverings (with input from Ship's Force (or custodian for boat or craft), when possible), using all available samples supplied by the manufacturer.

4.3 The exact location of work will be indicated in the invoking Work Item, including the type (and grade or class) of deck covering, the location (space name and number and if entire space, within the coaming, not under furniture, etc.) and the required Table, Line, and Column from 009-32 of 2.1 for surface preparation. Locations that are to retain underlayment or base coats must also be indicated as such in the invoking Work Item (e.g., replacing deck covering down to existing underlayment or base coats, replacing deck covering systems down to bare substrate or partial replacement of existing deck covering system).

4.4 If cleaning and painting of 3.7 or 3.9.12 is required; the use of Category II Standard Item 009-32 "Cleaning and Painting Requirements; accomplish" of 2.1 will be specified in the Work Item.

## ATTACHMENT A

### CERAMIC TILE (QUARRY AND PORCELAIN)

1. Ceramic tile includes both porcelain and quarry tiles and must be installed in locations listed in Table 2.

A. Ceramic tile must meet the requirements of ANSI A137.1 (available from the Tile Council of North America) and be unglazed, with a minimum coefficient of friction (COF) of 0.7 dry and 0.6 wet when tested in accordance with ASTM C1028.

B. Adhesive and grout must both be epoxy, chemical resistant, and water cleanable, in accordance with ANSI A118.3.

C. The underlayment must be in accordance with 3.9.

D. Concrete.

(1) Fabricate and install box units around hard to reach areas, i.e., vent ducting, stuffing tubes, and pipe brackets.

(2) Apply concrete by pouring into boxed area to produce slope towards deck drains and to provide vertical surfaces and square corners that suit application of cove tiles.

(3) Remove box units after concrete is cured.

E. Adhesive (mortar) and tile.

(1) Apply an ANSI A118.3 epoxy adhesive to the deck and on vertical surfaces up 4 inches from the deck.

(2) Ceramic cove base and bull nose top pieces must be used on the vertical portions of the tile system.

(3) The tiles must be stored flat.

(4) The application and installation of adhesive and tile may have to be accomplished in sections if the area is so large as to prevent laying tiles within adhesive pot-life.

(5) Periodically lift a set tile and inspect to ensure that 100 percent contact between adhesive and tile is achieved and that there is no entrapped air in the adhesive.

(6) Tiles, adhesive and deck must be allowed to stabilize to a temperature as close as practicable to room temperature, but in all cases between 64 degrees Fahrenheit and 81 degrees Fahrenheit for a period of 24 hours before, during, and after installation.



(7) The deck should be protected from traffic for 24 hours after installation and must not be washed for 48 hours following installation.

F. Grout.

(1) Mix and apply an ANSI, A118.3 epoxy grout by working it into tile seams to ensure air pockets are eliminated.

(2) Clean epoxy grout residue from the surface of the tile.

(3) Protect tile from foot traffic for a minimum of 24 hours.

G. Deck drain sealant installation. In the area between the tile, adhesive, and collar joint, install a waterproof sealant conforming to SAE-AMS-S-8802, Class B; MIL-A-46106, Group I, Type I; 3M 5200 Fastcure Marine Sealant; or NAVSEA-approved equivalent, around the entire circumference of the deck drain to the tile and adhesive interface.

## ATTACHMENT B

### WEAR RESISTANT DECK TILE

1. Wear resistant deck tiles must be installed in locations listed in Table One.

A. The wear resistant deck tile materials must be qualified under MIL- PRF-32170.

B. The adhesive must be as recommended by the manufacturer. For adhesive application, the substrate temperature must be between 64 degrees Fahrenheit and 81 degrees Fahrenheit, with a maximum relative humidity of 75 percent. The temperature and relative humidity must be stabilized for 24 hours prior to installation and for 24 hours following the installation.

C. Tile:

(1) Tiles, adhesive and sub-floor should be allowed to stabilize to a temperature as close as practicable to room temperature, but in all cases must be between 64 degrees Fahrenheit and 81 degrees Fahrenheit for a period of 24 hours before, during and after tile installation.

(2) The tiles must be stored flat.

(3) The deck should be protected from traffic for 24 hours after tile installation and must not be washed for 48 hours following installation.

(4) Do not spring wear resistant deck tiles into position. Tiles requiring hand cutting must not be cut oversize and then sprung (forced) into position. The tile must be cut such that they fit neatly into position without a gap between them and not requiring bending or application by force. Tiles can be taped together with masking tape to pull joints together during curing of the adhesive.

(5) The deck should be rolled initially by hand with a vinyl seam roller. Two to 4 hours after application of the adhesive, but prior to adhesive setting, the tiled surface should be rolled with a 100 lb. floor tile roller to ensure a good bond between the tiles, adhesive, and sub-floor.

(6) Clean away excess adhesive before it is allowed to dry. For water based adhesive use a soft cloth moistened with denatured alcohol. Do not use mineral spirits, which will cause swelling and have a tendency to curl.

D. Seal all edges of the tile including penetrations for pipes, foundations, vents, and other structures with a waterproof sealant conforming to SAE-AMS-S-8802, Class B; MIL-A-46106, Group I, Type I; 3M 5200 Fastcure Marine Sealant; or NAVSEA-approved equivalent.

## ATTACHMENT C

### CHEMICAL-RESISTANT FLOORINGS

1. Chemical-resistant floorings must be installed in locations listed in Tables One and 2.

A. The chemical-resistant flooring materials must be qualified under MIL-PRF-32584, Types IV or V, and listed on the QPL.

B. If aggregate is required to meet the coefficient of friction (COF) requirements of MIL-PRF-32584, an aggregate (e.g., white aluminum oxide or glass beads) must be included in the final seal coat to provide slip resistance.

C. The materials must be stored at a temperature between 60 degrees Fahrenheit and 80 degrees Fahrenheit for best application properties.

D. Maintain deck surface and room temperature in accordance with the NAVSEA-reviewed manufacturer's instructions and procedures submitted in 3.2 for proper curing during application and for at least 24 hours after installation.

E. For complete replacement of color-flake deck coverings, apply base coat, color coat, color chips and sealer coat (as applicable for the specified Class) in accordance with NAVSEA-reviewed ASTM F-718s and/or manufacturer's instructions submitted in 3.2. Color chips must be applied to the color coat in an even distribution. The color chip area to total color coat area ratio must be installed in accordance with the color-flake percentage as specified on the QPL. When multiple sealer coats are required, lightly abrade each sealer coat and solvent wipe the abraded surface before applying the next coat.

F. For resealing of color-flake deck coverings, abrade the existing sealer coat. Apply new color chips to maintain the chip coverage of the color coat. Apply sealer coat in accordance with NAVSEA-reviewed ASTM F-718s and/or manufacturer's instructions. Repair localized areas of torn, punctured or defective base coat to achieve a consistent appearance. When multiple sealer coats are required, lightly abrade each sealer coat and solvent wipe the abraded surface before applying the next coat.

## ATTACHMENT D

### ELECTRICAL GRADE SHEETING AND MATTING

1. Electrical grade sheeting and matting must be installed in locations listed in Table One.

A. The electrical grade sheeting and matting materials must be qualified under MIL-DTL-15562.

B. The electrical grade sheeting adhesive must be installed over the entire deck in accordance with manufacturer's instructions.

C. Heat welded electrical seams must provide a continuous surface to prevent a path for grounding. Where seams are inaccessible they must be sealed with a waterproof sealant conforming to SAE-AMS-S-8802, Class B; MIL-A-46106, Group I, Type I; 3M 5200 Fastcure Marine Sealant; or NAVSEA-approved equivalent. Electrical matting seams must not be within 914 mm (3 ft) of electrical/electronic equipment, panels, and workbenches. If this is unavoidable, heat-weld the seams to provide a continuous surface free of seams, craters, or porosities.

D. Seal all edges of the electrical sheet including penetrations for pipes, foundations, vents, and other structures with a waterproof sealant conforming to SAE-AMS-S-8802, Class B; MIL-A-46106, Group I, Type I; 3M 5200 Fastcure Marine Sealant; or NAVSEA-approved equivalent.

2. Exposed corners of electrical grade matting must be rounded off.

A. Installation of the mat with adhesive is optional, but if the mat is installed without adhesive, an outline of the area covered by the mat must be stenciled on the deck. Inside the outlined area the following must be stenciled in 20 mm (0.8 inch) or larger letters: "ELECTRICAL GRADE MAT REQUIRED WITHIN MARKED LINES".

B. Over removable deck plates, the mats must be installed without adhesive and marked as detailed above. Seams must be backed with 20 mil thick polyvinyl chloride tape, with a high-tack adhesive, 7 kN/m (40 lb/in) breaking strength, a dielectric strength of 20,000 volts in accordance with ASTM D1000, and with a 50 mm (2-inch) minimum overlap under each side of the seam.

## ATTACHMENT E

### CARPETING

1. Carpeting must be installed in locations listed in Table One.

A. Carpets must cover the deck completely, but must be fitted around all permanently installed furniture.

B. Carpets must be installed without pad over underlayment, primed steel or aluminum deck by a tackless procedure, or with an adhesive as recommended by the carpet manufacturer. For DDG 51-Class ships, acoustic insulation is authorized for use under carpeting in CO and XO cabins.

C. A clean, bright CRES or aluminum transition strip must be installed to secure the edges of the carpet in foot traffic areas where the carpet abuts other deck covering.

## ATTACHMENT F

### SOLID VINYL AND VINYL COMPOSITION TILE

1. Solid vinyl and vinyl composition tile must be installed in locations listed in Table One.

A. Vinyl composition deck tiles must conform to ASTM F1066, Class 2, and must be 1/8-inch thick for maximum durability. Solid vinyl tile must conform to ASTM F1700, Class III (commercial), Type B.

B. Vinyl tile epoxy adhesive must be a qualified proprietary part of the new deck covering system applied in accordance with NAVSEA-reviewed manufacturer's instructions and procedures submitted in 3.2.

C. Installations must be bulkhead to bulkhead and squared off on adjacent stiffeners and stanchions. Where the exposed edge fails to butt up against a fitting or bulkhead, a vinyl beveled edge strip or a stainless/brass strip (one inch by 0.08 inch) must be installed (with epoxy adhesive) to the deck to protect the edge.

D. Seal all edges of the tile including penetrations for pipes, foundations, vents, and other structures with a waterproof sealant conforming to SAE-AMS-8802, Class B; MIL-A-46106, Group I, Type I; 3M 5200 Fastcure Marine Sealant; or NAVSEA-approved equivalent.

## ATTACHMENT G

### MIL-PRF-24667, Type XI NONSKID (PEEL AND STICK)

1. MIL-PRF-24667, Type XI nonskid must be installed in locations listed in Tables One and 2 and listed within 2.3. Exterior applications for MIL-PRF-24667, Type XI nonskid are located in Table 2 of 009-32 of 2.1.

A. The MIL-PRF-24667, Type XI nonskid materials must be qualified under MIL-PRF-24667, Type XI, Comp PS.

B. Spaces between adjacent pieces must have a minimum gap of 1/2 inch and maximum gap up to 1-1/2 inches. This spacing should align with weld seams to the maximum extent practicable so as to avoid the material from bridging these seams.

C. For exterior applications only, seal all free edges of the MIL-PRF- 24667, Type XI nonskid with the manufacturer's approved sealer.

Verify that the sealer bead covers both the edge of the product and the substrate surface. The edge sealer must be dry to the touch in accordance with ASTM D1640 prior to permitting foot traffic.

D. MIL-PRF-24667, Type XI nonskid must not be used in areas frequently contaminated with hydrocarbons (e.g. hydraulic fluid, fuel, oil) as well as pallet jack, and fork truck traffic areas.

E. Corners of MIL-PRF-24667, Type XI nonskid must be rounded.

2. If approved by the SUPERVISOR, existing areas of MIL-PRF-24667, Type XI nonskid can be repaired by removing worn or damaged areas. Product removal must be accomplished in accordance with the manufacturer's instructions.

3. Surfaces must be prepared to a minimum surface preparation level of SSPC- SP 11 and be painted prior to application of the MIL-PRF-24667, Type XI nonskid.

A. If approved by the SUPERVISOR, for areas where the paint is intact, surface preparation and painting is not required. The surface must be cleaned of all loose debris and be detergent washed or solvent wiped to remove all surface contaminants. Any existing areas of paint damage must be touched up.

4. MIL-PRF-24667, Type XI nonskid must be installed in accordance with manufacturer's documentation.

5. Color topping is authorized as required for safety markings.

## NOTES OF TABLES ONE AND 2 FOR SURFACE SHIPS

- (1) High durability deck coating, MIL-PRF-32584, Types I and II, have significantly lower total ownership costs than all other decking materials.
- (2) Chemical-resistant flooring, MIL-PRF-32584, materials qualified to Type V do not require an underlayment to create a coaming or slope to a drain and therefore have a lower total ownership cost than Type IV materials which require an underlayment.
- (3) When no products are listed on wear resistant deck tiles, MIL-PRF-32170, Class 1, qualified products database (QPD), solid vinyl tile in accordance with Attachment F may be substituted.
- (4) Listed spaces may be designated as an electrical space, requiring electrical grade sheeting, MIL-DTL-15562. (For example: If the pilot house is designated an electrical space, the entire floor will require MIL-DTL-15562 sheeting.)
- (5) If MIL-DTL-15562, Type I, electrical grade sheeting is not installed in designated electrical spaces, then localized installation of MIL-DTL-15562, Type II or III matting is required in areas where specific electrical hazards may exist in accordance with 3.9.13.
- (6) Install MIL-PRF-24667, Type XI nonskid in working areas around machinery.
- (7) INTENTIONALLY LEFT BLANK
- (8) Two-inch square, three-inch square, or four-inch square tiles must be used.
- (9) Quarry tile must be 0.5-inch by six-inch by six-inch.
- (10) Four-inch square, six-inch square, or eight-inch square tiles must be used.
- (11) If no products are listed on QPL-32584, utilize the legacy QPLs as listed below,
  - a. MIL-PRF-32584, Type I: MIL-PRF-32171, Type I
  - b. MIL-PRF-32584, Type II: MIL-PRF-32171, Type III
  - c. MIL-PRF-32584, Type III: MIL-PRF-32171, Type IV
  - d. MIL-PRF-32584, Type IV: MIL-PRF-24613, Types I, II, III, or IV
  - e. MIL-PRF-32584, Type V: MIL-PRF-24613, Types V or VI
  - f. MIL-PRF-32584, Type VI: MIL-D-21631
- (12) Do not topcoat latex concrete installed in magazines and ammunition holds. For magazine areas without latex concrete, paint steel decks with the epoxy system of surrounding decks. Large magazine areas receive nonskid in accordance with MIL-PRF-24667 as directed by the SUPERVISOR. Small magazine areas are topcoated with haze gray #26270 MIL-PRF-24635 Type V/VI paint, with the



exception of saluting charge and OTTO fuel magazines which are painted white, MIL-DTL-24441, Type IV, Formula 152.

TABLE ONE DRY INTERIOR SPACES	LINE	A PRIMARY DECK COVERING	B ELECTRICAL GRADE SHEETING OR MATTING	C NONSKID, MIL- PRF- 24667, TYPE XI
LIVING AND WORKING SPACES (E.G. OFFICES AND BERTHING), MAIN PASSAGEWAYS, MESSING AREAS, BARBER SHOP, MANNED STOREROOMS AND SHIP'S STORE  SEE NOTE (1)	1	CHEMICAL-RESISTANT FLOORING, MIL-PRF-32584, TYPES IV OR V  SEE NOTE (2)	ELECTRICAL GRADE SHEETING OR MATTING, MIL-DTL-15562, TYPE I, II OR III  SEE NOTES (4) & (5)	
	2	HIGH DURABILITY DECK COATING, MIL-PRF- 32584, TYPE I	SAME AS LINE ONE	
	3	WEAR RESISTANT DECK TILE, MIL-PRF-32170, CLASS 1 - OR -SOLID VINYL OR VINYL COMPOSITION TILE  SEE NOTE (3)	SAME AS LINE ONE	
PILOT HOUSE AND CONTROL STATIONS, CHART ROOM AND COMBAT INFORMATION CENTER  SEE NOTE (1)	4	CHEMICAL RESISTANT FLOORING, MIL-PRF-32584, TYPES IV OR V  SEE NOTE (2)	SAME AS LINE ONE	
	5	HIGH DURABILITY DECK COATING, MIL-PRF-32584, TYPE I	SAME AS LINE ONE	

TABLE ONE DRY INTERIOR SPACES	LINE	A PRIMARY DECK COVERING	B ELECTRICAL GRADE SHEETING OR MATTING	C NONSKID, MIL- PRF- 24667, TYPE XI
	6	WEAR RESISTANT DECK TILE, MIL-PRF-32170, CLASS 1- OR -SOLID VINYL OR VINYL COMPOSITION TILE SEE NOTE (3)	SAME AS LINE ONE	
FLAG QUARTERS, CO AND XO QUARTERS, TROOP CO QUARTERS  SEE NOTE (1)	7	CARPET		
	8	HIGH DURABILITY DECK COATING, MIL- PRF- 32584, TYPE I		
	9	CHEMICAL- RESISTANT FLOORING, MIL-PRF-32584, TYPES IV OR V  SEE NOTE (2)		
	10	WEAR RESISTANT DECK TILE, MIL-PRF-32170, CLASS 1 - OR - SOLID VINYL OR VINYL COMPOSITION TILE  SEE NOTE (3)		
WARDROOM, CPO LOUNGE, LIBRARY, CLASSROOM AND CHAPEL  SEE NOTE (1)	11	CHEMICAL RESISTANT FLOORING, MIL-PRF-32584, TYPES IV OR V  SEE NOTE (2)		

TABLE ONE DRY INTERIOR SPACES	LINE	A PRIMARY DECK COVERING	B ELECTRICAL GRADE SHEETING OR MATTING	C NONSKID, MIL- PRF- 24667, TYPE XI
	12	HIGH DURABILITY DECK COATING, MIL-PRF-32584, TYPE I		
	13	WEAR RESISTANT DECK TILE, MIL-PRF-32170, CLASS 1- OR -SOLID VINYL OR VINYL COMPOSITION TILE  SEE NOTE (3)		
MEDICAL AND DENTAL SPACES SEE NOTE (1)	14	CHEMICAL- RESISTANT FLOORING, MIL-PRF-32584, TYPES IV OR V  SEE NOTES (2)		
	15	HIGH DURABILITY DECK COATING, MIL-PRF-32584, TYPE I		
LABORATORY SPACES, DESIGNATED ELECTRICAL SPACES (E.G. CCTV CONTROL ROOMS, ELECTRIC POWER CONVERSIONS, IC AND GYRO ROOMS, RADAR ROOMS, AND CONTROL ROOMS), AND ELECTRICAL/ELECTRONI C WORKSHOPS  SEE NOTE (1)	16	ELECTRICAL GRADE SHEETING, MIL-DTL-15562, TYPE I  SEE NOTE (5)		
	17	HIGH DURABILITY DECK COATING, MIL-PRF- 32584, TYPE I	SAME AS LINE ONE	

TABLE ONE DRY INTERIOR SPACES	LINE	A PRIMARY DECK COVERING	B ELECTRICAL GRADE SHEETING OR MATTING	C NONSKID, MIL- PRF- 24667, TYPE XI
	18	CHEMICAL- RESISTANT FLOORING, MIL-PRF-32584, TYPES IV OR V  SEE NOTE (2)	SAME AS LINE ONE	
CARPENTER AND MACHINE SHOPS AND OTHER SHOP SPACES	19	HIGH DURABILITY DECK COATING, MIL-PRF-32584, TYPE I	SAME AS LINE ONE	NONSKID, MIL-PRF-24667, TYPE XI, COMP PS  SEE NOTE (6)
SIDE PASSAGEWAYS (INTERIOR) ONLY SERVING SHOP SPACES (NOT MAIN PASSAGEWAYS)	20	HIGH DURABILITY DECK COATING, MIL-PRF-32584, TYPE I		
CARGO AMMUNITION HOLDS (BETWEEN DUNNAGE TRACKS)	21	LATEX CONCRETE, MIL-PRF-32584, TYPE VI  SEE NOTE (11) & (12)		
MACHINERY SPACES (EXCLUDING BILGES) IN WORKING AREAS	22	HIGH DURABILITY DECK COATING, MIL-PRF-32584, TYPE I	SAME AS LINE ONE	SAME AS LINE 19
DRY GOODS STOREROOMS	23	HIGH DURABILITY DECK COATING, MIL-PRF-32584, TYPE I		

TABLE ONE DRY INTERIOR SPACES	LINE	A PRIMARY DECK COVERING	B ELECTRICAL GRADE SHEETING OR MATTING	C NONSKID, MIL- PRF- 24667, TYPE XI
AIR LOCKS AND LIGHT TRAPS	24	HIGH DURABILITY DECK COATING, MIL-PRF-32584, TYPE I		
OTHER INTERIOR SPACES	25	HIGH DURABILITY DECK COATING, MIL-PRF-32584, TYPE I	SAME AS LINE ONE	SAME AS LINE 19

TABLE 2 WET INTERIOR SPACES	LINE	A PRIMARY DECK COVERING	B ELECTRICAL GRADE SHEETING OR MATTING	C NONSKID, MIL-PRF- 24667, TYPE XI
SANITARY SPACES (WASHROOMS, WATER CLOSETS, AND SHOWERS)  SEE NOTE (1)	1	PORCELAIN TILE  SEE NOTE (8)		
	2	HIGH DURABILITY DECK COATING, MIL-PRF-32584, TYPE II		
	3	CHEMICAL-RESISTANT FLOORING, MIL-PRF-32584, TYPES IV OR V  SEE NOTE (2)		
SMALL ENCLOSED SPACES ADJOINING SANITARY SPACES (HOT WATER HEATER SPACES, CG LOCKER, ETC.)  SEE NOTE (1)	4	CHEMICAL-RESISTANT FLOORING, MIL-PRF-32584, TYPES IV OR V  SEE NOTE (2)		
	5	HIGH DURABILITY DECK COATING, MIL-PRF-32584, TYPE II		
FOOD SERVICE SPACES (GALLEY, SCULLERY, BUTCHER SHOP, BAKERY, MEAT PREPARATION ROOMS, FOOD SERVICE LINES)  SEE NOTE (1)	6	QUARRY TILE  SEE NOTE (9)		
	7	HIGH DURABILITY DECK COATING, MIL-PRF-32584, TYPE II		
	8	PORCELAIN TILE  SEE NOTE (8)		

TABLE 2 WET INTERIOR SPACES	LINE	A PRIMARY DECK COVERING	B ELECTRICAL GRADE SHEETING OR MATTING	C NONSKID, MIL-PRF- 24667, TYPE XI
TRASH COMPACTOR ROOMS SEE NOTE (1)  TRASH COMPACTOR ROOMS SEE NOTE (1)	9	CHEMICAL RESISTANT FLOORING, MIL-PRF-32584, TYPES IV OR V SEE NOTE (2)		NONSKID, MIL-PRF-24667, TYPE XI, COMP PS  SEE NOTE (6)
	10	HIGH DURABILITY DECK COATING, MIL-PRF-32584, TYPE II		SAME AS LINE 9
	11	QUARRY TILE  SEE NOTE (9)		SAME AS LINE 9
WALKING AREAS OF OTHER WET WORKING SPACES (NIXIE ROOMS, ETC.)	12	HIGH DURABILITY DECK COATING, MIL-PRF-32584, TYPE II		SAME AS LINE 9
LAUNDRY FACILITIES SEE NOTE (1)	13	CHEMICAL RESISTANT FLOORING, MIL-PRF-32584, TYPES IV OR V  SEE NOTE (2)		SAME AS LINE 9
	14	HIGH DURABILITY DECK COATING, MIL-PRF-32584, TYPE II		SAME AS LINE 9
	15	PORCELAIN TILE  SEE NOTE (10)		SAME AS LINE 9
AFFF STATIONS	16	AFFF STATION DECK COATING, MIL-PRF- 32584, TYPE III		



TABLE 2 WET INTERIOR SPACES	LINE	A PRIMARY DECK COVERING	B ELECTRICAL GRADE SHEETING OR MATTING	C NONSKID, MIL-PRF- 24667, TYPE XI
OTHER MANNED SPACES	17	HIGH DURABILITY DECK COATING, MIL-PRF-32584, TYPE II		SAME AS LINE 9
OTHER UNMANNED SPACES	18	HIGH DURABILITY DECK COATING, MIL- PRF-32584, TYPE II		

NAVSEA  
STANDARD ITEM

FY-24

ITEM NO: 009-27  
DATE: 25 OCT 2022  
CATEGORY: II

1. SCOPE:

1.1 Title: Material Identification and Control (MIC) for Level I System; accomplish

2. REFERENCES:

2.1 Standard Items

2.2 0948-LP-045-7010, Material Control Standard

2.3 S9086-GY-STM-010/CH-221, Boilers

3. REQUIREMENTS:

3.1 Provide and maintain a Material Identification and Control (MIC) System in accordance with 2.2 for both Government furnished and contractor furnished materials utilized in the installation, alteration, and repair of systems or portions of systems designated as MIC LEVEL I by Work Items in the Job Order. The system must be described in a written procedure that must be submitted to the SUPERVISOR for review and approval prior to implementation. The procedure requires a one-time submittal/approval unless the Standard Items change and/or references change or are updated. The Material Identification and Control program for Level I Materials must be subject to periodic conformity audits by the SUPREVISOR throughout the contract period. This procedure must specifically address, as a minimum, the following:

3.1.1 Assignments of responsibility for identification and control of LEVEL I material including working level instructions for:

3.1.1.1 Procurement of pre-certified LEVEL I material from an authorized LEVEL I certifying activity or National Stock System.

3.1.1.2 Inspection of pre-certified LEVEL I material in accordance with Section 3.4 of 2.2.

3.1.1.3 Storage of LEVEL I material including segregation from non-LEVEL I materials.

3.1.1.4 Issue of LEVEL I material including transfer of marking for raw materials (e.g., bar, pipe, tube and threaded rod).

3.1.1.5 Identification and control of LEVEL I material during all phases of work (e.g., material movement, manufacturing, repair, ripout, installation).

3.1.1.6 Local manufacturing and testing of LEVEL I components manufactured from certified raw materials.

3.1.1.7 Visually verifying at the time of or subsequent to installation into a system subassembly or aboard ship that the permanent material designator markings, material type for fasteners or grade/type for consumable materials are correct in accordance with the generic material requirements of applicable drawing and/or NAVSEA-approved nonconformances and Engineering Changes.

3.1.1.8 Documentation of installation of LEVEL I material in accordance with Section 3.10.3 of 2.2.

3.2 Accomplishment of a Process Control Procedure (PCP) for all work within the LEVEL I boundary including manufacture, installation and repair of LEVEL I systems, components and material must be in accordance with NAVSEA Standard Items (See Note 4.2) except for the following actions:

3.2.1 Software replacement (e.g., O-rings, packing glands, body-to-bonnet gaskets, silver seal replacements).

3.2.2 Inspection to support routine maintenance programs or troubleshooting.

3.2.3 Replacement of any non-pressure boundary parts which are not LEVEL I parts.

3.3 Submit one legible copy, in approved transferrable media, of the completed LEVEL I work item including the required installation records to the SUPERVISOR at the completion of work and/or a minimum of one day prior to system testing/operation.

3.3.1 For those work items that require a PCP per 3.2, in lieu of the report required in 3.3, submit one legible copy, in approved transferrable media, of the completed PCP documentation required by 009-09 of 2.1 at the completion of work and/or a minimum of one day prior to system testing/operation.

#### 4. NOTES:

4.1 LEVEL I designation applies only to materials specified in 2.2 and Section 221-2.17 of 2.3.

4.2 If a Process Control Procedure (PCP) for all work within the LEVEL I boundary including manufacture, installation and repair of LEVEL I systems, components and material in 3.2 is required; the use of a Category II Standard Item 009-09 "Process Control Procedure (PCP); provide and accomplish" of 2.1 will be specified in the Work Item.

NAVSEA  
STANDARD ITEM

FY-24

ITEM NO: 009-30  
DATE: 25 OCT 2022  
CATEGORY: II

1. SCOPE:

1.1 Title: Boiler Sample Tube; inspect

2. REFERENCES:

2.1 S9221-C1-GTP-010, Main Propulsion Boilers; Repair and Overhaul

3. REQUIREMENTS:

3.1 Remove tubes using tube-sampling methods in accordance with Paragraph 3.4 of 2.1.

3.1.1 Cut generating tubes removed as samples 8 to 10 inches above the water drum.

3.2 Identify and metal-tag tubes, tube stubs, and tube sections removed, with ship's name and hull number, Work Item number, boiler number, tube designation, bottom and top of sections, segment sequence, upstream side (furnace face), and downstream side of gas flow.

3.2.1 Cut tube removed into 3-foot minimum segments and split longitudinally by mechanical method with tube dry (no oil) so that upstream side (furnace face) half is split from side downstream of gas flow half.

3.2.1.1 There must be 2 distinct, individual halves to each segment, tube stub, and bend.

3.2.1.2 Each half (waterside/steamside and fireside) must remain intact.

3.2.2 Identify and metal-tag each segment and half in accordance with 3.2 so that full length of tube may be reconstructed and placement oriented.

3.3 Inspect tube segments for the following:

3.3.1 Steamsides/watersides:

3.3.1.1 Oil deposits

3.3.1.2 Loose sludge

- 3.3.1.3 Hard baked-on sludge
- 3.3.1.4 Scale
- 3.3.1.5 Scabs/tubercles
- 3.3.1.6 Pitting
- 3.3.1.7 High temperature oxides
- 3.3.1.8 Waterside grooves
- 3.3.1.9 Corrosion fatigue fissures
- 3.3.1.10 General waterside thinning
- 3.3.1.11 Waterside burning
- 3.3.1.12 Waterside abrasion
- 3.3.1.13 Die marks
- 3.3.1.14 Steam tracking
- 3.3.1.15 Stress corrosion cracking (caustic embrittlement)
- 3.3.2 Firesides:
  - 3.3.2.1 General fireside thinning
  - 3.3.2.2 Fireside burning
  - 3.3.2.3 Tube enlargement
  - 3.3.2.4 Swaging
  - 3.3.2.5 Sagging
  - 3.3.2.6 Warping
  - 3.3.2.7 Heat blisters
  - 3.3.2.8 Thermal cracks
  - 3.3.2.9 Mechanical fatigue cracks

3.3.2.10 Steam gouging

3.3.3 Submit one legible copy, in approved transferrable media, of a report listing results of the requirements of 3.3 to the SUPERVISOR.

3.4 Collect samples (equal to a heaping tablespoon each) of waterside soft and hard deposits for each boiler.

3.4.1 Soft deposits - Place the tube segments in a vise with the waterside up and wirebrush watersides. Collect loose residue in a bottle. Label bottle with the title Soft Deposits, ship, boiler number, and tube number.

3.4.2 Hard deposits - Place the tube segment in a vise with the waterside up and power wirebrush watersides to remove loose residue. Crimp the tube segment slowly allowing flakes of hard sludge to fall back into the tube. Collect the loose flakes in a bottle. Label bottle with title Hard Deposits, ship, boiler number, and tube number.

3.5 Package tubes, deposit samples, and a copy of report (3.3.3) and send to a laboratory qualified to accomplish chemical analysis.

3.5.1 Analyze the tube samples for the following:

3.5.1.1 Tube wall thickness at zero, 90, 180, and 270-degree positions

3.5.1.2 Extent of pitting (major pit depths and average overall pitting)

3.5.1.3 Thickness of hard scale mineral deposits

3.5.2 Analyze deposit samples for specific mineral composition in percentages of calcium, magnesium, and silicon oxide.

3.5.3 Submit one legible copy, in approved transferrable media, of a report listing results of the requirements of 3.5.1 and 3.5.2 to the SUPERVISOR.

4. NOTES:

4.1 Sample tube(s) replacement will be included in the invoking Work Item.

NAVSEA  
STANDARD ITEM

FY-24

ITEM NO: 009-31  
DATE: 25 OCT 2022  
CATEGORY: II

1. SCOPE:

1.1 Title: Boiler Waterjet Cleaning; accomplish

2. REFERENCES:

2.1 S6300-AE-MMA-010, Waterjet, Model WBD-150N, Operation, Maintenance, Repair and Overhaul Procedures

3. REQUIREMENTS:

3.1 Accomplish the requirements of this item for waterjet cleaning of boiler watersides, using manufacturer's equipment manual and 2.1 for guidance.

3.1.1 Portable extension lights must conform to MIL-F-16377/49, Symbol 306.2 or MIL-F-16377/52, Symbol 286.

3.1.1.1 Ground each light fixture at the voltage source.

3.1.2 The high-pressure waterjet cleaning unit must be operated at no more than 10,000 pounds per square inch (PSI).

3.1.3 Rope off and post warning signs in the areas where the unit is operating, where the high-pressure hose is run, and where the waterjet cleaning is to be accomplished.

3.1.4 Unit must be stopped immediately if high-pressure leaks occur in pump, piping, high-pressure hose, or hose couplings.

3.1.5 While personnel are waterjetting, lance operator must be in direct visual contact with control gun operator stationed outside of boiler. Control gun operator must also maintain direct person-to-person voice communication with pump operator, using telephone, radio, or other positive direct means. Communication relay through intermediaries is not acceptable.

3.1.6 The control gun operator must be able to regulate the flow of water to permit the system to be pressurized during the actual tube cleaning and have the nozzle pressure reduced to zero while the operator removes the lance from one tube and inserts it into the next tube to be cleaned.

3.2 Cleaning equipment must meet minimum requirements listed herein:

3.2.1 Supply hose from the pump to the control gun must be 1/2-inch inside diameter (I.D.) with 30,000 PSI minimum burst pressure and must not exceed 400 feet in length. A 15-foot length of supply hose must be attached between the control gun and the flexible lance.

3.2.2 Provide a high pressure return line from the control gun dump connection to the waterjet supply tank, on units that discharge pressure to the bilges between cycles.

3.2.3 Tube cleaning nozzle must be non-rotating. Orifices in the nozzles must be angled back 30 degrees. Nozzles must have a minimum of 18 orifices evenly spaced around the circumference. Each orifice must be 0.024 inch in diameter, plus or minus 0.001 inch.

3.2.4 Fan pattern nozzle attached to a rigid lance for cleaning drum and header surfaces.

3.2.5 Lance and nozzle burst pressure ratings must be 25,500 PSI minimum. Lance must be 0.229 inch or larger I.D. and must have a smooth Teflon core, and must not exceed 25 feet in length.

3.2.6 Waterjet cleaning solution must consist of one pound of sodium nitrite to 100 gallons of clean, fresh water.

3.3 Maintain operating pressures and flow rates for boiler cleaning as follows:

3.3.1 Boiler tube cleaning - 10,000 PSI maximum, 9,000 PSI minimum pump discharge pressure at 20 gallons per minute.

3.3.2 Drum and header surface cleaning - 7,500 PSI maximum, 6,500 PSI minimum pump discharge pressure, at 12 to 14 gallons per minute.

3.4 Verify waterjet cleaning equipment capability prior to commencement of work.

3.4.1 Place the lance and nozzle that will be utilized in waterjet cleaning securely into a container. Ensure lance cannot break loose and that unit output is 20 gallons per minute.

3.5 Accomplish cleaning operations as follows:

3.5.1 Lance and nozzle must traverse the entire length of every tube cleaned.

3.5.1.1 Downcomer, riser, and support tubes must be traversed twice.

3.5.2 The lance and nozzle must traverse the tubes at a maximum rate of one foot per second.



3.5.3 A fan nozzle must be used to clean entire interior drum surfaces.

3.6 Pump waterjet wastewater effluent from boiler to a holding container or a waterjet wastewater recycling unit. Do not drain wastewater to bilges.

3.6.1 Waterjet wastewater recycling filter process must be capable of filtering the wastewater effluent to meet the following criteria:

Suspended Solids	< 10 mg/L
Sodium Nitrite	1100 - 1300 mg/L
Ph	6.5 - 8.5
Nitrate	< 10 mg/L
Oil and Grease	< 5 mg/L

3.6.1.1 Recycled wastewater discharge samples must be taken every 3,000 gallons to ensure levels do not exceed the above criteria.

3.6.2 Remove and dispose of spent chemicals and solutions in accordance with federal, state, and local regulations.

3.6.3 Accomplish a fresh water flush of all internal surfaces cleaned in 3.5.

3.7 Dry tubes, headers, drums, and downcomers using clean, dry air immediately upon completion of waterjet cleaning. Remove pockets of water and dry surfaces using clean rags.

(V)(G) "CLEANLINESS"

3.8 Inspect surfaces to ensure the following requirements are met:

3.8.1 Surfaces must be dry.

3.8.2 There must be no evidence of flash rusting.

3.8.3 There must be a streaking effect seen when looking into the tubes. The streaking effect must begin within one to 2 inches from the tube end and continue through the visible length of the tube.

3.8.4 Soft deposits and obstructions must be removed.

3.8.5 Residual sodium nitrite deposits remaining after the surfaces are dried is acceptable.

4. NOTES:

4.1 None.

NAVSEA  
STANDARD ITEM

FY-24

ITEM NO: 009-32  
DATE: 25 OCT 2022  
CATEGORY: II

1. SCOPE:

1.1 Title: Cleaning and Painting Requirements; accomplish

2. REFERENCES:

2.1 Standard Items

2.2 S9086-VD-STM-010/CH-631, Preservation of Ships in Service - General

2.3 29 CFR 1915, Occupational Safety and Health Standards for Shipyard Employment, Subparts C and Z

2.4 S9510-AB-ATM-010/(U), Nuclear Powered Submarine Atmosphere Control Manual

2.5 Systems and Specifications, SSPC Painting Manual, Volume 2

2.6 MS6310-081-015, Submarine Preservation

2.7 S6360-AG-MAN-010, Surface Ship Exterior Appearance Manual

2.8 ASTM D4417, Standard Test Methods for Field Measurement of Surface Profile of Blast Cleaned Steel

2.9 NACE International Standards

2.10 ISO 8502-3, Assessment of Dust on Steel Surfaces Prepared for Painting (Pressure Sensitive Tape Method)

2.11 S9086-CN-STM-020/CH-079, Damage Control - Practical Damage Control

2.12 S9086-RK-STM-010/CH-505, Piping Systems

3. REQUIREMENTS:

3.1 General Preservation Requirements:

3.1.1 Consider marine coatings, decking systems, and abrasive blasting media to contain heavy metals (e.g., beryllium, cadmium, chromium, or lead), hexavalent chromium, crystalline silica and/or other toxic or hazardous substances.

3.1.2 Accomplish safety precautions as specified in 2.2, 2.3, and the Work Item or task order during surface preparation and the application or removal of marine coatings.

3.1.2.1 Excluding underwater hull coatings that will contain heavy metals, plan for the removal of marine coatings that contains heavy metals up to the specified amount:

#### Marine Coating Removal Per Ship Class

Ship Class	Square Foot of Removal
Aircraft Carriers (CVN)	200
Amphibious Assault Ships (LHD, LHA)	150
Amphibious Command Ships (LCC)	150
Guided Missile Cruisers (CG)	150
Amphibious Transport Docks (LPD)	100
Amphibious Dock Landing Ships (LSD)	100
Guided Missile Destroyers (DDG)	100
Submarines (SSGN, SSBN, SSN)	50
Littoral Combat Ships (LCS)	50
Mine Counter Measures Ships (MCM)	50
Coastal Patrol Ships (PC)	50
Repair and Berthing Barge (YRB, YRBM)	50

3.1.2.2 If the total costs are less than the cost to remove the authorized square footage, remaining funds will be subject to recoupment. The contractor is not authorized to exceed these limits.

3.1.2.3 For deck coverings installed onboard submarines, NAVSEA-approved deck covering systems must comply with the requirements of 2.4.

#### 3.1.3 Blast Media:

3.1.3.1 Maintain a current copy of material certification of abrasive blast media conforming to MIL-A-22262, A-A-1722, A-A-59316, SSPC-AB 3, or SSPC-AB 4 for reference by the SUPERVISOR. Copy must be available prior to blasting. When using stainless steel media, maintain a current copy of the manufacturer's commercial data sheet to validate media contains a minimum of 10.5 percent chromium. Copy must be available prior to blasting. MIL-A-22262 abrasives must be listed on the Qualified Products List (QPL), or the repair activity must have written notification from NAVSEA indicating pending listing on the QPL. Submit one legible copy, in hard copy or approved transferrable media, to the SUPERVISOR upon request. For A-A-1722, A-A-59316, SSPC-AB 3, or SSPC-AB 4 abrasives, a complete data package demonstrating compliance with the requirements must be provided by the supplier to the procuring activity. Exceptions are listed in 3.1.3.2 and 3.1.3.3.

3.1.3.2 Recyclable Encapsulated Abrasive Media material conforming to SSPC-AB 4 may be used as an alternative to obtain NACE 2/SSPC-SP 10 or SSPC-SP 11 cleanliness.

3.1.3.3 Recyclable ferrous metallic abrasive materials conforming to SSPC-AB 3 of 2.5 may be used as an abrasive blast media for steel substrates. Cleanliness of recyclable ferrous metallic abrasive materials must be measured and maintained in accordance with the requirements of SSPC-AB 2 of 2.5.

3.1.3.4 For requirements specified in 3.1.3.3, maintain a current copy of the results of the quality control requirements of Paragraph 6 of SSPC-AB 2 and quality assurance test required by Paragraph 5 of SSPC-AB 3 of 2.5 for reference by the SUPERVISOR.

Submit one legible copy, in hard copy or approved transferrable media, to the SUPERVISOR upon request.

3.1.3.5 Steel media, defined as steel shot, steel grit; stainless steel media, defined as stainless steel shot, stainless steel grit; and SSPC-AB 4 media containing steel abrasive MUST NOT be used for surface preparation on LHA, LHD, LPD, LSD and ESB Class ship flight deck, hangar, vertical replenishment deck, elevators, catwalk, and superstructure above the flight deck. Steel media may be used on tanks and voids below the flight, hangar, and vehicle storage decks and associated ramps with containment that prevents release of the steel media onto the flight deck, hangar, vertical replenishment deck, elevators, catwalk, and superstructure above the flight deck. SSPC-AB 4 media that does not contain steel abrasive or MIL-A-22262 abrasive may be used on flight decks and other areas of LHA, LHD, LPD, and LSD Class ships. The following checkpoints apply ONLY when steel media is being used on an LHA, LHD, LPD, or LSD Class ship on tanks and voids below the flight, hangar, and vehicle storage decks and associated ramps.

#### (V)(G)"STEEL MEDIA BLASTING PROCESS AND MEDIA CONTAINMENT INSPECTION"

3.1.3.6 Steel media may be used on tanks and voids below the flight, hangar, and vehicle storage decks and associated ramps with containment that prevents release of the steel media onto the flight deck, hangar, vertical replenishment deck, elevators, catwalk, and superstructure above the flight deck.

3.1.3.7 Accomplish a start of blasting media containment inspection to ensure blast media is contained within the confines of the work area. Any media detected outside of the containment must be reported to the SUPERVISOR.

#### (V)(G)"FINAL BLASTING MEDIA VISUAL INSPECTION"

3.1.3.8 Accomplish a visual inspection to ensure all media, wastes from steel media blasting, and steel media blasting equipment is completely removed from the ship. Any media detected outside of the containment or left on the ship must be reported to the SUPERVISOR.

3.1.3.9 Recycled, non-metallic abrasive blast media conforming to MIL-A-22262, A-A-1722, or SSPC AB-1 can be used for abrasive blasting processes as specified in the invoking Work Item or Task Order. Sampling and testing of the recycled, non-metallic abrasive must meet the requirements for cleanliness (oil and conductivity) contained in SSPC AB-1 (paragraph 4.1.14 Water Soluble Contaminants, and 4.1.6 Oil Content) once per day. Recycling of non-metallic grit must be accomplished using equipment meeting CID A-A-60016.

3.1.4 Abrasive blast steel plates and shapes, and ferrous piping to NACE 2/SSPC-SP 10 of 2.5 and 2.9 and aluminum plates and shapes to SSPC-SP 17 of 2.5. Establish a surface profile that meets the requirements of 3.10.5, and coat, prior to shipboard installations except in the areas where weld joints remain to be accomplished, or unless specified otherwise in the invoking Work Item or task order. Material for fuel oil storage, fuel oil service, and diesel service tanks must not be painted. If these materials are to be installed in potable water, reserve

feedwater, or freshwater drain collection tanks, they must be blasted and coated at a maximum 50 percent relative humidity from surface preparation checkpoint acceptance until cure to recoat time of final touch-up of the topcoat; for materials to be installed in all other areas, they must be blasted and coated at a maximum 85 percent relative humidity; this requirement supersedes Notes (26) and (29A).

3.1.4.1 For tanks, when masking is removed from the open ends of piping, the piping may retain tightly-adherent paint or remain bare up to 6 inches above the open end. Loose or delaminating paint must be prepared to SSPC-SP 2.

3.1.4.2 For non-ferrous piping which penetrates bulkheads, extend paint one to 2 inches (onto the pipe) beyond the bulkhead penetration pipe-weld.

3.1.4.3 Non-ferrous piping and cable pans, which are to be preserved shipboard, must be prepared in accordance with SSPC-SP 2 or SSPC-SP 16 of 2.5. For painted non-ferrous piping and cable pans in tanks of nuclear powered ships, surface preparation must be in accordance with SSPC-SP 16 of 2.5. The SSPC-SP 16 cleaning of non-ferrous piping may be accomplished utilizing ferrous abrasive media. Non-ferrous piping one inch in diameter or less must not be prepared or painted; do not remove intact adherent coating from piping. Surface profile is not required.

3.1.4.4 Diffusers in reserve feedwater dump tanks must not be painted.

3.1.4.5 Existing ferrous piping in tanks and voids may be prepared in accordance with NACE 4/SSPC-SP 7 of 2.5 and 2.9.

3.1.5 With the exception of potable water, reserve feedwater, freshwater drain collecting tanks, and nonskid system applications (MIL-PRF-24667) for steel substrates on surface ships, preconstruction primer may be retained and overcoated with applicable coating systems specified in Tables One through 5, if the preconstruction primer application process meets the following:

3.1.5.1 The preconstruction primer must be a zinc silicate material. Compatibility with the coating systems specified in Tables One through 5 must be confirmed by the coating manufacturer.

3.1.5.2 The preconstruction primer must be applied in a process which is certified to ISO 9001, SSPC-QP 1, or SSPC-QP 3. The surface must meet the requirements of NACE 2/SSPC-SP 10 of 2.5 and 2.9, and the process must be verified to meet the technical requirements of 3.10.2, 3.10.5, and 3.10.6 a minimum of once per shift.

3.1.5.3 The maximum relative humidity requirement of 3.10.1 must be 85 percent.

3.1.5.4 The secondary surface preparation, once the steel is installed shipboard, must be accomplished in accordance with 3.1.5.5 through 3.1.5.8.

3.1.5.5 Accomplish degreasing/cleaning prior to surface preparation to ensure that the surface is free of contaminants in accordance with SSPC-SP 1 of 2.5.

3.1.5.6 Brush-off blast clean the preconstruction primer-coated surface to NACE 4/SSPC-SP 7 of 2.5 and 2.9 to remove contaminants and loose paint. A thorough pressure wash of the area with fresh water at 3,000 to 5,000 pounds per square inch (PSI) may be substituted for the degreasing/cleaning to SSPC-SP 1 and the brush-off blast to NACE 4/SSPC-

SP 7. For cumulative surface areas less than 10 percent of the total area, with no individual area greater than 10 square feet, an SSPC-SP 3 cleaning followed by a fresh water wipe may be substituted for NACE 4/SSPC-SP 7.

3.1.5.7 For weld joints where the preconstruction primer was burned away, and for any other areas of visible rust where the preconstruction primer had been previously damaged, clean the affected areas to the level required by applicable Line in Tables One through 5.

3.1.5.8 Upon completion of secondary surface preparation, the surface must meet the requirements of SSPC-SP 1 of 2.5. A visual water break test (ASTM F-21 or F-22) on the surface may be used to validate SSPC-SP 1.

3.1.6 For touch-up, disturbed (terms are clarified in 3.6), and/or inaccessible areas, the minimum surface preparation must be that shown in Tables One through 8, except that an SSPC-SP 11 is acceptable for areas originally requiring a NACE 2/SSPC-SP 10 or NACE/SSPC-SP WJ-2. The decision that an area is inaccessible must be determined by inspection and agreed to by the SUPERVISOR prior to surface preparation. The degree of surface preparation required would be the maximum possible for that area, but could include retention of existing tightly adherent paint in inaccessible areas as defined by the SUPERVISOR.

3.1.7 Excluding potable water and reserve feedwater tanks in submarines and aircraft carriers, freshwater drain collecting tanks in aircraft carriers, and the reactor auxiliary room bilges in aircraft carriers, feathering is not required in tanks, voids, machinery spaces, or bilges. Feathering is required on the underwater hull and other areas as directed by the SUPERVISOR. Feathering is explained in more detail in 3.6.4.

3.1.8 Clean insulation and lagging prior to painting; ensure such areas are free of foreign matter and contaminants that would prevent adherence of paint.

3.1.9 Clean and dry all prepared and previously coated surfaces; ensure such surfaces are free of foreign matter that will affect adherence of coatings. Inclusions such as dust and debris in the coating film must be removed prior to the application of the next coat.

3.1.10 Record and restore existing painted labels, compartment designations, hull markings, interior photoluminescent tape/markings and other painted information which will be removed or covered during cleaning and coating operations, except for Visual Landing Aid (VLA) markings. VLA marking installation is addressed in 3.11.13.

3.1.11 Install masking material for protection of equipment and items not to be coated during preservation. Shipboard items not to be coated are listed in 2.2 and 2.6 and include bolted-crossbar aircraft securing fittings installed on aluminum flight decks. Remove masking material upon completion of final coating.

3.1.12 Clean shoe coverings must be worn when walking on prepared or coated surfaces. Shoe coverings must be selected that do not degrade and contaminate surfaces.

3.1.13 The requirements stated herein take precedence over all referenced documents if there is a conflict.

3.1.13.1 Unless otherwise specified herein, coatings listed on the QPL must be applied. All coatings are to be applied in accordance with the manufacturer's NAVSEA-reviewed ASTM F718 product data sheet. The requirements stated herein take precedence over the NAVSEA-reviewed ASTM F718 data sheets if there is a conflict. The

NAVSEA-reviewed ASTM F718 data sheets must supersede any other manufacturer's ASTM F718 data sheets for that product, even if it is newer (more recent) than the NAVSEA-reviewed ASTM F718 data sheets. Copies of the NAVSEA-reviewed ASTM F718 data sheets are available from the Naval Surface Treatment Center (NST Center) website: <http://www.nstcenter.biz>.

3.1.14 Store coating system components in a cool, dry place. Do not expose to freezing temperatures or direct sunlight. For all coatings, storage ambient temperature must be maintained between 50 and 90 degrees Fahrenheit, or within the manufacturer's recommended storage temperature range with written authorization from the SUPERVISOR. Low temperature nonskid systems (nonskid and primer) must be stored between 65 and 85 degrees Fahrenheit with the optimal storage temperature being between 70 and 80 degrees Fahrenheit.

3.1.14.1 Monitor the storage temperature over the 24-hour period prior to initiation of the application process and document the minimum and maximum temperatures. If recorded manually, temperature must be recorded once per shift (not to exceed 12 hours) during the 24-hour period. Manual readings are not necessary if monitoring equipment is used that tracks minimum and maximum temperature for the 24-hour period.

3.1.14.2 When approved by the SUPERVISOR, as an alternative to the storage monitoring requirement for coatings in 3.1.14.1, a maximum of 1 hour before application of products, measure individual components (after each is mixed, but before components are combined together) with a coating thermometer to confirm that each component of the system is within the required range.

3.1.14.3 When MIL-PRF-23236 Type VII coatings are applied using a plural component spray pump with recirculation and preheating, the 24-hour storage temperature requirement is waived.

3.1.15 All coating containers must be free of leaks and ill-fitting lids and manufacturer labels must be legible at time of application.

3.1.16 When applying paint, multiple coats must be of contrasting colors, unless specifically stated otherwise in Tables One through 8.

3.1.17 When using multiple component (such as 2-part) coating systems (e.g., epoxies and polyurethanes), use of "partial kits" is prohibited unless using verified proportioning equipment or other verified measuring equipment (gravimetric).

3.1.18 Use of partial kits is prohibited for nonskid.

3.1.19 For surface ships, for commercial underwater hull coating systems including anti-corrosive paints and antifouling paints, the manufacturer's primer must be used with its antifouling paint. No substitution is allowed. Successive coats of anti-corrosive paints must be of a contrasting color. Coats of antifouling paints must be of the colors stated in Tables One through 5.

3.1.19.1 For all ships, antifouling paint may be repaired, touched-up, and/or overcoated as defined in 4.3 with any other approved ablative antifouling system, and approved antifouling paints may be applied over any approved exterior anti-corrosive system. Antifouling paints must be Type I or II; this does not apply to foul release (Type III) coatings.

3.1.20 Apply the first coat of MIL-PRF-24647 antifouling paint when the last coat of epoxy paint is still tacky (as defined in 3.6.3) and in accordance with applicable NAVSEA-

reviewed ASTM F718. If the maximum recoat time for the epoxy is exceeded, accomplish the overcoat window requirements of 3.5, then apply a tack coat of epoxy paint one to 2 milli-inches (mils) wet film thickness (WFT) over previously painted surfaces. The epoxy tack coat must be allowed to cure until tacky, and then the first full coat of antifouling paint must be applied.

3.1.20.1 The requirement for the last coat of epoxy to be tacky prior to application of the first coat of antifouling is waived if the NAVSEA-reviewed ASTM F718 states the minimum and maximum overcoat interval between the last coat of epoxy and application of the first coat of antifouling.

3.1.21 Mix and apply all coatings in accordance with the product’s NAVSEA-reviewed ASTM F718, except for invoked requirements for surface preparation and DFT as specified in Tables One through 8.

3.1.21.1 Coatings that are past their shelf life / expiration date must not be applied without written authorization from the SUPERVISOR.

3.1.22 The final coat of the underwater hull coating system on boats and small craft that are embarked on surface ships or otherwise deployed must be gray.

3.1.23 Utilize water-based latex fire retardant paints in preference to chlorinated alkyd-based fire retardant paints in areas where condensation, high humidity, and temperatures below 50 degrees Fahrenheit are not expected during application and cure. Such paints are available under MIL-PRF-24596.

3.1.24 Mix and apply the Navy Polyamide Epoxy MIL-DTL-24441 paints in accordance with the following, except the DFT must be as specified in Tables One through 8. The MIL-DTL-24441 paints’ mixing ratio is one-to-one by volume. The components of the various formulas are not interchangeable. Blend each component thoroughly prior to mixing the components. After mixing equal volumes of the 2 components, the mixture must be thoroughly stirred. For Type III only, the stand-in times listed below must be observed. There is no induction time for Type IV.

3.1.24.1 Stand-in time (induction time) for MIL-DTL-24441 Type III is considered to be the time immediately following the mixing of components A and B, during which the critical reaction period of these components is initiated and is essential to the complete curing of the paint. During stand-in time, the mixture must be thoroughly stirred at least once every 20 minutes to avoid hot spots caused by localized overheating from the chemical reaction.

<u>Surface Temperature at Worksite (Degrees Fahrenheit)</u>	<u>Stand-In Time in Hours</u>
35 to 50	2 hours at 70 degrees Fahrenheit (paint temperature)
50 to 60	2 hours at worksite temperature
60 to 70	One hour to 1-1/2 hours at worksite temperature
70 to 90	1/2 to one hour at worksite temperature

3.1.25 For proper curing, the maximum application and cure temperature for MIL-DTL-24441 products must be 90 degrees Fahrenheit (ambient and surface temperature).



3.1.26 Powder coating application may be used if approved by the SUPERVISOR; otherwise use applicable Lines in Tables One through 8. Powder coatings may be overcoated with liquid paints. Powder coated items require near white metal blast, NACE 2/SSPC-SP 10 surface preparation. Any use of a chemical pretreatment (e.g., phosphate conversion coatings) requires approval by NAVSEA. For areas listed in 3.7, quality assurance (QA) checkpoints are still required for items that are powder coated.

3.1.26.1 Powder coatings are not practical for use on large components or ship structure. Any large-scale applications to ship structure require approval by NAVSEA.

3.1.26.2 Powder coating is not authorized for use on components, covers, or any parts to be installed in potable, reserve feed water, or freshwater drain collecting tanks aboard nuclear powered ships.

3.1.26.3 For surface ships, SUPERVISOR approval must denote specific items or classes of items and applications.

3.1.26.4 For submarines, powder coating may be used if approved by the SUPERVISOR. Thermoplastic powder coatings (such as vinyls, nylons, polyethylenes, and polypropylenes) are not authorized for interior submarine applications and powder coatings are prohibited for use on those components and coating applications governed by reactor plant paint schedules. Application of thermoset powder coatings to approved components using the electrostatic spray method are to be accomplished in accordance with Uniform Industrial Process Instruction 0631-901, "Electrostatic Powder Coating" or equivalent as approved by the SUPERVISOR. Interior and exterior miscellaneous metal components to be powder coated must be non-reactor plant miscellaneous components.

3.1.26.5 Air flasks may be powder coated as approved by the SUPERVISOR.

3.1.27 For peel and stick nonskid (MIL-PRF-24667 Type XI, Composition PS), interior and exterior applications on surface ships must be in accordance with NAVSEA Standard Items (see Note 4.10). Exterior applications require material designated as coarse on NAVSEA-reviewed manufacturer's instructions.

3.1.27.1 For submarines, peel and stick nonskid are approved for limited interior application during Chief of Naval Operations availabilities in dry dock only.

3.1.27.2 Peel and stick nonskid must not be painted or color-topped for cosmetic purposes. MIL-PRF-24667 color topping is authorized as required for safety or VLA markings.

3.1.27.3 Peel and stick nonskids are mandatory for use on masts, antenna platforms, and yardarms receiving nonskid. Peel and stick nonskids are mandatory for use on all superstructure walking surfaces, ladders and platforms leading to the flight deck, missile platforms, and antenna platforms on LHA/LHD Class ships.

3.1.27.4 Do not install peel and stick nonskid on diamond plate.

3.1.27.5 Peel and stick nonskid must not be used in areas frequently contaminated with hydrocarbons (e.g. hydraulic fluid, fuel, oil) as well as pallet jack, and fork truck traffic areas.

3.1.28 Paints used on interior spaces of submarines are approved under the Submarine Atmosphere Control Program and listed on the Submarine Material Control List. For interior use on submarines, only those MIL-PRF-23236 Type VII paints listed in Note (8A) may be used. For use in tanks, voids, and freefloods on submarines, only use paints listed in Table 8.

3.1.29 For submarines, inspections and repairs required by the SUPERVISOR must be accomplished before the prime coat is applied if using high solids paints. Upon completion of structural repairs, the affected areas must be abrasive blasted to NACE 2/SSPC-SP 10 prior to paint application unless otherwise specified.

3.1.30 Restrictions on repair activity personnel (which includes Contractors) working in propulsion plant spaces aboard nuclear powered ships must be in accordance with NAVSEAINST 4350.2 (Series) (Contract Work Onboard Nuclear-Powered Ships).

3.1.31 For nuclear powered ships, surfaces covered by a reactor plant paint schedule must use that schedule for all preservation and painting requirements for those surfaces.

3.1.32 For areas that require 100 percent preservation or structural repairs or modification, coating removal may be accomplished prior to starting the repairs without the requirements of 009-32 applying until full surface preparation can be accomplished in accordance with the applicable Table and Line.

(I) "CLEANING"

3.1.32.1 Accomplish the requirements of SSPC-SP 1 of 2.5 prior to coating removal. For areas prepared to NACE/SSPC-SP WJ-2 of 2.5 and 2.9 with ultra high pressure waterjetting (UHP WJ) equipment, the requirement of initial degreasing/cleaning is waived. A visual water break test (ASTM F-21 or F-22) on the surface may be used to validate SSPC-SP 1 and NACE/SSPC-SP WJ-2 of 2.5 and 2.9.

3.1.33 For tank, void, vent plenum bolting ring, and manhole cover gasket seating surfaces, accomplish the requirements of SSPC-SP 15 of 2.5. Then apply one coat of appropriate MIL-PRF-23236 primer or tank system coating at 6-8 mils, or 2 coats of appropriate MIL-DTL-24441 tank system coating at 2-4 mils/coat. Maintain relative humidity at a maximum of 85 percent. This requirement supersedes Notes (26) and (29A).

3.1.34 Coatings must not be thinned.

3.2 Stripe Coat Requirements:

3.2.1 For all areas where stripe coating is required, as denoted in Tables One through 8, apply stripe coat in accordance with applicable NAVSEA-reviewed ASTM F718 data sheet to edges, weld seams, welds of attachments and appendages, cutouts, corners, butts, foot/handholds, pipe welds, and other mounting hardware (non-flat surface). Stripe coat these areas after the previous coat has dried and inspections in accordance with 3.10.9 have been completed. The stripe coat must encompass all edges as well as at least a one inch border outside each edge and weld. As directed by the SUPERVISOR during final touch-up of all tank coatings including potable water, reserve feedwater, or freshwater drain collecting tank, stripe coat requirements are waived for individual areas not greater than 1/2 inch in diameter and cumulative areas less than one square foot for each tank work zone. For submarines, solvent-based paints must have the stripe coat applied by brush. Flow exposed welds that have undergone contouring for hydrodynamic considerations do not require stripe coating.

3.2.1.1 Each stripe coat must be of the specified paint system and must be a different color from both the paint over which it is being applied and the next coat in the system (if a product only comes in 2 colors, the stripe coat must contrast with the color of the previous coat). Full coat inspection must be conducted prior to stripe coat application.

3.2.2 A stripe coat is no longer specified for MIL-PRF-23236 Type VII paints.

3.2.3 Excluding aluminum substrates, stripe coats are not required when applying coatings to non-ferrous metals or corrosion resistant steels. Stripe coat aluminum in accordance with Tables One through 8.

3.3 Cure time is dependent on temperature; products applied at lower temperature will need more time to cure. This includes low temperature coatings. Cure time of each coat must be in accordance with NAVSEA-reviewed ASTM F718 unless otherwise specified in the following requirements or as specified in Note (6) for surface ships and Note (4A) for submarines:

3.3.1 Drying time between coats of a specified paint for potable, reserve feedwater, and freshwater drain collecting tanks must be a minimum of 36 hours (for paint applied to more than 2 percent of the tank surface area) or 12 hours (for paint applied to 2 percent or less of the tank surface area) at a minimum temperature of 70 degrees Fahrenheit (substrate and ambient), using heated air if necessary to maintain temperature. Ventilation must be sufficient to ensure continuous flow of air through the tanks with at least one complete air change every 4 hours. For potable water tanks coated with MIL-PRF-23236 Type VII Class 9 and Class 9/18 paints and reserve feedwater tanks on non-nuclear ships coated with MIL-PRF-23236 Type VII Class 11 and 11/18 paints, see Note (55) for surface ships and Note (39A) for submarines.

3.3.2 Following paint application, potable, reserve feedwater, and freshwater drain collecting tanks must be continuously ventilated with a minimum of one complete air change every 4 hours for at least 5 consecutive days prior to filling with water. During the ventilation period, maintain a minimum tank temperature of 70 degrees Fahrenheit (substrate and ambient). Verify and document daily that ventilation is properly installed and operating (document on QA Checklist Form Appendix 1). For potable water tanks coated with MIL-PRF-23236 Type VII Class 9 and Class 9/18 paints and reserve feedwater tanks on non-nuclear ships coated with MIL-PRF-23236 Type VII Class 11 and 11/18 paints, see Note (55) for surface ships and Note (39A) for submarines.

3.3.2.1 For potable water tanks, once the final topcoat is fully cured (as defined in the product's NAVSEA-reviewed ASTM F-718 data sheet), inspect the surface for cleanliness. Verify that the surface meets the requirements of SP 1 by wiping all tank surfaces with potable water applied to clean, light-colored rags. When wiping, the surface must, when viewed without magnification, be free of all visible oil, grease, dust, dirt, and other foreign matter. Any surfaces producing visible contamination on a rag must be re-cleaned until both rag and surface are visually free of contamination. As an option to wiping the tank, the tank must be completely filled with potable water and drained at least twice to ensure tank cleanliness.

3.3.3 Prior to application of any MIL-PRF-24635 over an epoxy paint, the epoxy must be dry to the touch but not fully cured (as defined on the epoxy paint's NAVSEA-reviewed ASTM F-718 as cure to service) before overcoating. The epoxy must be overcoated with MIL-PRF-24635 within 7 days of the epoxy application. Dry to the touch is defined in ASTM D1640.

3.3.4 Prior to application of any water-based paint, such as MIL-PRF-24596, over an epoxy paint, allow the epoxy to dry for at least 16 hours.

### 3.4 Overcoating of MIL-DTL-24441 with MIL-DTL-24441:

3.4.1 If less than 7 days has elapsed since the application of the prior coat, the next coat may be applied after visual inspection to confirm the absence of grease, dirt, salts, or other surface contaminants. If surface contamination is suspected as a result of visual inspection or for other reasons, the entire surface must be cleaned in accordance with SSPC-SP 1 of 2.5. The next coat of MIL-DTL-24441 must be applied after surfaces are completely dried.

3.4.2 If more than 7 days but less than 30 days has elapsed since the application of the prior coat, the entire surface must be cleaned in accordance with SSPC-SP 1 of 2.5. Ensure the surface has fully dried, and then apply a mist coat (one to 2 mils WFT) of the last coat applied or Formula 150. The mist coat must be allowed to cure (dry) for 4-8 hours; then apply the next full coat of the system. This condition can only be met one time during the painting system application. For areas less than or equal to 2 percent of the surface being prepared, the process in 3.4.3 may be used.

3.4.3 If more than 30 days has elapsed since the application of the prior coat, the entire surface must be cleaned in accordance with SSPC-SP 1 of 2.5. After allowing the surface to dry, the surface must be lightly abraded to degloss the epoxy, using a brush-off abrasive blast (preferred), power sanding, or hand sanding using 80-120 grit, then apply the next full coat of the system.

### 3.5 Overcoating of Non-MIL-DTL-24441 Epoxy Paints:

3.5.1 Follow the manufacturer's NAVSEA-reviewed ASTM F718 instructions for the allowable overcoat window, but must not to exceed 30 days. The 30-day maximum may be extended beyond 30 days if specifically documented on the NAVSEA-Reviewed ASTM F718 and approved by NAVSEA. Where the base coat and topcoat are provided from different manufacturers, the term "manufacturer" refers to the manufacturer of the base coat. Application of a mist or tack coat must not restart the 30-day window.

3.5.1.1 If either the manufacturer's NAVSEA-reviewed ASTM F718 instructions or the 30-day window (or a specific extension approved by NAVSEA) has been exceeded, the paint must be reactivated by following the instructions of the manufacturer's NAVSEA-reviewed ASTM F718 for reactivating the surface, as approved by the SUPERVISOR.

### 3.6 Clarification of Terms:

3.6.1 Touch-up of in-service coatings (i.e., not newly-installed coatings) is defined differently within this Standard Item for surface ships and submarines.

3.6.1.1 Except for potable, reserve feedwater, or freshwater drain collecting tanks, touch-up is defined within this Standard Item for submarines as preservation operations on cumulative surface areas less than 10 percent of the total area being preserved, as approved by the SUPERVISOR. Included under touch-up operations are new and disturbed surfaces of less than 4 square feet. Except for potable, reserve feedwater, or freshwater drain collecting tanks, the documentation requirements of 3.7 and 3.8.1 are replaced with Appendix 9 or Naval Shipyard QA Checklist Form Appendix 6 for touch-up of in-service coatings (3.8.1.1 is still required), and the requirements of 3.10.2, 3.10.5, 3.10.6, 3.10.7, and 3.10.9 must be verified by the accomplishing activity as (I) inspections.

3.6.1.2 For potable, reserve feedwater, or freshwater drain collecting tanks on nuclear powered surface ships, touch-up is defined within this Standard Item as

preservation operations on cumulative surface areas less than one percent of the total area being preserved, with no individual area greater than 10 square feet. Included under touch-up operations are new and disturbed surfaces of less than 10 square feet.

3.6.1.3 For surface ship areas, except for potable, reserve feedwater, freshwater drain collecting tanks on nuclear powered surface ships and LHA/LHD flight deck nonskid, touch-up is defined within this Standard Item as preservation operations on cumulative surface areas less than or equal to 10 percent of the total area (e.g., bilge, tank, space, etc.) being preserved, with no individual area greater than 10 square feet. Included under touch-up operations are new and disturbed surfaces of less than 10 square feet. The documentation requirements of 3.7 and 3.8 are waived for touch-up of in-service coatings, and the requirements of 3.10.2/3.11.3, 3.10.5/3.11.4, 3.10.6/3.11.5, 3.10.7/3.11.6, and 3.10.9/3.11.10 must be verified by the accomplishing activity as (I) inspections.

3.6.1.4 Except for reserve feedwater and freshwater drain collecting tanks on nuclear powered ships and submarines, touch-up of in-service MIL-DTL-24441 and MIL-PRF-23236 paint systems may be performed interchangeably using any of these paints specified in the applicable lines of Tables One through 8. MIL-PRF-23236 coatings must not be installed in reserve feedwater and freshwater drain collecting tanks.

3.6.1.5 On surface ships and submarines, excluding potable water, reserve feedwater, fresh water drain collecting tanks and flight deck nonskid, for new and disturbed areas of individual areas 2 square feet or less totaling less than 0.03 percent of the total surface area, the requirements of Notes (26) and (29A) do not apply. The requirements to perform and document the following paragraphs are waived: 3.10.1/3.11.2, 3.10.2/3.11.3, 3.10.5/3.11.4, 3.10.6/3.11.5, 3.10.7/3.11.6, and 3.10.9/3.11.10; the documentation requirements of 3.7 and 3.8 are also waived. The requirement of 3.10.1.1 must be accomplished, but not documented. For paint application, apply paints in accordance with Tables One through 8 with the following exception: apply only one coat of primer on prepared substrate, followed by topcoat product applied to overlap intact paint by a minimum of one inch around primer.

3.6.1.6 For areas of touchup of 6 square inches or less total cumulative area within a tank, visual inspection only of the touchup area is authorized. All other QA requirements specified in 3.10 are not required.

3.6.2 Disturbed surfaces are defined as any surface that requires cleaning and/or coating due to existing coating finish being damaged in the accomplishment of work specified by the Work Item or task order.

3.6.2.1 Exterior surfaces of underwater hull closure plates/hull accesses and their associated welds will not be considered disturbed surfaces and must be cleaned, prepared, painted, and documented in accordance with the applicable area. For surface ships, deviations from the requirements may be authorized by the SUPERVISOR based on size, location, application, or severity of condition of the paint system being applied.

3.6.2.2 Interior surfaces of underwater hull closure plates/hull access-associated welds must have surface preparation in accordance with 3.1.6.

3.6.2.3 The word "new" in "new and disturbed surfaces" refers to all material installed on the ship by the repair activity regardless of source.

3.6.3 Tacky is defined as that curing (drying) timeframe when a fingertip pressed lightly, without twisting, against the paint film leaves no residue on the finger, until the time when the finger leaves only a slight impression on the surface of the paint film.

3.6.4 Accomplish feathering of adherent paint remaining after the required surface preparation by creating a smooth, 1 to 2 inch wide transition area between the prepared surface and the adherent paint using hand or power tool sanding or grinding.

3.6.5 Solvent wipe is defined as cleaning a surface by pouring solvent on a clean, light colored rag and subsequently wiping the surface.

3.6.6 Initiation of the application process is defined as the time when a coating is removed from storage for staging at the worksite, but is not the start date/time for applying the coating.

3.6.7 Creditable Cure Time (CCT) is defined as the accrued time for which data shows compliance with environmental requirements collected in accordance with 3.10.1. CCT is accrued based on established environmental data collection intervals (e.g., 4 hours, 12 hours, 24 hours) when consecutive environmental readings are shown to satisfy the requirements of 3.10.1. Regardless of elapsed overall time between consecutive acceptable environmental readings, CCT equivalent to a single data collection interval (e.g., 4 hours, 12 hours, 24 hours) is accrued.

3.7 The following ship structural surfaces are defined as critical coated areas:

<u>SURFACES</u>	<u>TYPE OF SUBSTRATE</u>
Underwater hull, including appendages and surfaces below the waterline up to and including the boottopping	All
Cofferdams	Steel and aluminum
Hangar, flight, vertical replenishment, and aircraft elevator platform decks	Steel and aluminum
Recovery, Assist, Securing and Traversing (RAST) track trough (including sumps)	Steel and aluminum
Well deck overheads and enclosed boat handling areas	Steel and aluminum
Surface ship bilge, drain sump, and drain well	Steel and aluminum
Interior surfaces of vent plenums, defined as combustion air intakes (gas turbine, diesel, and steam), including Collective Protection System (CPS) intake vent plenums and other vent system plenums with openings greater than 7 square feet	Steel and aluminum
Tanks and floodable voids (including sumps, covers, and bolting rings)	Steel and aluminum
Non-floodable voids (at waterline or below)	Steel and aluminum
Surface ship Vertical Launch System (VLS), MK-41	Steel and aluminum
DDG-51 Class top of stacks (i.e., 05 level weather decks and bulwarks)	Steel
Gas turbine exhaust uptake spaces and trunks	Steel
All recesses on submarines below the upper boottop	Steel
Interior surfaces of submarine sail (fairwater) and superstructure when SSPC-SP 10 is accomplished	Steel

<u>SURFACES</u>	<u>TYPE OF SUBSTRATE</u>
Aircraft Launch and Recovery Equipment (ALRE) System defined herein as catapult wing voids, catapult troughs, catapult exhaust blowdown trunks, barricade stanchions and wells, catapult jet blast deflector pits, and associated void spaces	Steel
Arresting gear sheave foundations	Steel
Valve Regulated Lead Acid (VRLA) Battery Compartment at conversion	Steel
Submarine rescue vehicle seating surfaces	Steel

3.7.1 Record and maintain in-process records in Coating QA Tool Kit (CQATK) paperless QA program (or NAVSEA-approved equivalent) or on QA Checklist Form Appendices as blasting, coating, inspections, and tests are being accomplished. CQATK program and installation setup are available upon request from the Global Distance Support Center (GDSC), <http://www.navy311.navy.mil>, 1-855-NAVY-311.

3.7.1.1 For surface ship nonskid work in multiple areas to be coated, a detailed sketch must be completed for each area or zone of installation to indicate the area of work.

3.7.1.2 QA documentation must include 3.7.1.3 through 3.7.1.11. QA Checklist Form Appendices of 2.1 are available at <http://www.nstcenter.biz>.

3.7.1.3 Ambient and substrate surface temperatures, relative humidity, and dew point during preservation process (QA Checklist Form Appendix 1);

3.7.1.4 Cleaning/degreasing prior to surface preparation inspection results (QA Checklist Form Appendix 2 or Naval Shipyard QA Checklist Form Appendix 6);

3.7.1.5 Surface profile readings and surface preparation method, including name of abrasive and QPL-22262 revision number from which the product was purchased (as applicable), or copy of NAVSEA product approval letter. (QA Checklist Form Appendix 3 or Naval Shipyard QA Checklist Form Appendix 3 or 3A);

3.7.1.6 Surface conductivity test results (QA Checklist Form Appendix 4);

3.7.1.7 Surface cleanliness test results for dust (QA Checklist Form Appendix 5);

3.7.1.8 Name of coating, manufacturer, batch number, and date of expiration (QA Checklist Form Appendix 6);

3.7.1.9 Elapsed time between coats (QA Checklist Form Appendix 6);

3.7.1.10 DFT measurements (QA Checklist Form Appendix 7) and/or WFT measurements (QA Checklist Form Appendix 7A or Naval Shipyard QA Checklist Form Appendix 7);

3.7.1.11 Minimum and maximum storage temperatures of the coating over the 24-hour period prior to use (QA Checklist Form Appendix 1).

3.7.2 If using QA Appendices, submit one legible copy, in hard copy or approved transferrable media, of recorded in-process information on QA Checklist Forms to the SUPERVISOR within 72 hours of completion of preservation of each separate location listed in the invoking Work Item or task order.

3.8 Determine the type of surface preparation required and coating system options that are available for use in accomplishing the work.

3.8.1 Accomplish receipt inspection for coatings applied on aircraft carriers and submarines to areas listed in 3.7 (excluding underwater hull and nonskid systems) upon receipt from the manufacturer. Accomplish testing of the following properties in accordance with the requirement of the applicable specification and the manufacturer's certificate of compliance or conformance test data form. Receipt inspect coating components for density, fineness of grind, viscosity, and condition in container. Receipt inspect mixed coating for dry hard time, sag resistance, and color of dry film. Receipt inspection testing is not required for those characteristics that have satisfactory test data provided on the manufacturer's certificate of compliance or conformance test data forms, or another shipyard's receipt inspection test data forms that meet the applicable coating specification requirements. Submit one legible copy, in hard copy or approved transferrable media to the SUPERVISOR upon request.

3.8.1.1 On all ships for coatings applied to areas listed in 3.7, maintain on file the original manufacturer's certificate of compliance and material conformance test data in accordance with Section 11 of 2.2. Submit one legible copy, in hard copy or approved transferrable media to the SUPERVISOR upon request.

3.8.1.2 For areas listed in 3.7, if requested by the SUPERVISOR, prepare and submit one legible copy, in hard copy or approved transferrable media, of Coatings Application Product Summary (CAPS) sheet (QA Checklist Form Appendix 8).

3.9 Maintain the following certifications for accomplishing preservation operations to areas as listed in 3.7. Information for these certifications can be found at [www.ampp.org/certification](http://www.ampp.org/certification).

3.9.1 Coating inspectors must be certified in accordance with the NAVSEA Basic Paint Inspector (NBPI) course, NACE International Coating Inspector Program (CIP) Level 1 or higher, or SSPC Protective Coating Inspector Program (PCI) Level 2. Coating inspectors must also have a minimum of 2 years of marine coatings related work experience.

3.9.2 Organizations performing blasting operations (abrasive and waterjetting) or coating application must be certified in accordance with QP 1 of 2.5 (with the exception of the Coating Application Specialist (CAS) requirement) or NAVSEA-approved equivalent.

3.9.2.1 For components that are removed from the ship and preserved, ISO 9001 or QP 3 may be substituted for QP 1.

3.9.3 Spray painters must be certified in accordance with SSPC C-12, SSPC C-14, SSPC CAS Level 2, or NAVSEA-approved equivalent. For equivalent certifications, a copy of the NAVSEA approval letter must be maintained by the repair activity.



3.9.4 Plural Component Pump Tenders and Applicators must be certified in accordance with SSPC C-14 or NAVSEA-approved equivalent certifications. For equivalent certifications, a copy of the NAVSEA approval letter must be maintained by the repair activity.

3.9.5 Blasters must be certified in accordance with SSPC C-7, SSPC CAS Level 2, or NAVSEA-approved equivalent. For equivalent certifications, a copy of the NAVSEA approval letter must be maintained by the repair activity.

3.9.6 Blasters performing UHP WJ must be certified in accordance with SSPC C-13 or NAVSEA-approved equivalent. For equivalent certifications, a copy of the NAVSEA approval letter must be maintained by the repair activity.

3.10 For all coating systems except surface ship nonskid, accomplish preservation operations in accordance with the following. For surface ship nonskid system application, refer to 3.11.

3.10.1 For coatings, take ambient and substrate surface temperatures, relative humidity, and dew point from conditions on-site, in close proximity to the structure being coated, for all areas listed in Tables One through 8.

3.10.1.1 Unless otherwise stated within the Notes of Tables One through 8, and as noted in 3.10.1.2, 3.10.1.3, and 3.11.2.3, coatings must be applied only when the ambient temperature and the temperature of the prepared substrate are 50 degrees Fahrenheit or greater and a minimum of 5 degrees Fahrenheit above the dew point. The maximum relative humidity must be 85 percent. For areas listed in 3.7, readings must be documented on QA checklist Form Appendix 1.

3.10.1.2 In areas where MIL-PRF-23236 Type VII Class 15B products are specified, these products are exempt from dew point and relative humidity requirements.

3.10.1.3 The only products that may be applied below 50 degrees Fahrenheit are those specified in the Tables and Notes for use below 50 degrees Fahrenheit.

3.10.1.4 These environmental readings must be taken from the surface preparation acceptance checkpoint to 48 hours of creditable cure time after the application of the final coat. Creditable cure time is defined in 3.6.7. For areas preserved under 3.6.1.1/3.6.1.3, environmental readings must be taken at the surface preparation acceptance checkpoint to 24 hours after application of the final coat. If a final coat fully cures to immersion/service in less than 48 hours (24 hours for 3.6.1.1/3.6.1.3), as defined in its NAVSEA-reviewed ASTM F718, environmental readings for that final coat must be taken until the product's cure to immersion/service time is reached. For potable, reserve feedwater, and freshwater drain collecting tanks on submarines and aircraft carriers, during inspection of each coat, the (G) point inspection must validate that the environmental readings during application and curing of that coat comply with applicable environmental requirements. All components blasted and primed in accordance with 3.1.4 must have environmental readings taken until the cure to recoat time is reached.

3.10.1.5 For potable, reserve feedwater, and freshwater drain collecting tanks, environmental readings must be taken from the surface preparation acceptance checkpoint to 5 days of creditable cure time after application of the final coat, unless otherwise stated in Tables One through 8.

3.10.1.6 The preferred method of measurement is use of a data logger. If a data logger is used, it must collect data at a minimum of every one hour. A manual reading must

be taken once every 24 hours and at every evolution involving (G)-points with a separate calibrated device independent of the data logger. For areas listed in 3.7, manual readings must be documented on QA Checklist Form Appendix 1. Maintain all data logger recorded data for the requirements of 3.10.1 with the QA appendices.

3.10.1.7 For areas where a data logger is not used, environmental readings must be manually taken every 4 hours and at every evolution involving (G)-points except as modified below. For areas listed in 3.7, readings must be documented on QA Checklist Form Appendix 1.

3.10.1.8 For areas where relative humidity is maintained (through the use of dehumidification equipment or forced hot air) below 50 percent and the surface temperature is greater than 5 degrees above the dew point, manual readings where a data logger is not used are required once every 12 hours and at every evolution involving a (G)-point. This requirement also applies to coatings covered under 3.10.1.2.

3.10.1.9 Environmental readings at (G)-points are only required within the timeframes given in 3.10.1.4 and 3.10.1.5.

3.10.1.10 Environmental readings must be monitored during application of powder coating products, but they do not need to be recorded.

3.10.1.11 Critical coated areas environmental requirements will be documented in accordance with paragraph 3.7.1.

(I) or (I) (G) "CLEANLINESS" (See 4.4)

3.10.2 Accomplish degreasing/cleaning prior to surface preparation to ensure that the surface is free of contaminants in accordance with SSPC-SP 1 of 2.5. For areas prepared to NACE/SSPC-SP WJ-2 of 2.5 and 2.9 with UHP WJ equipment, the requirement of initial degreasing/cleaning is waived. A visual water break test (ASTM F-21 or F-22) on the surface may be used to validate SSPC-SP 1 and NACE/SSPC-SP WJ-2 of 2.5 and 2.9. For areas listed in 3.7, document on QA Checklist Form Appendix 2 or Naval Shipyard QA Checklist Form Appendix 6.

3.10.2.1 Inspect the surface a maximum of 4 hours prior to start of coating removal to ensure accomplishment of SSPC-SP 1. For areas listed in 3.7, document on QA Checklist Form Appendix 2 or Naval Shipyard QA Checklist Form Appendix 6.

3.10.3 Except for tanks, surface preparation by abrasive blasting is prohibited on submarine interior surfaces, with the exception that use of self-contained Recyclable Encapsulated Abrasive Media material conforming to SSPC-AB 4 is permissible in submarine machinery spaces.

3.10.4 Limit the square footage of surfaces being prepared for preservation to an area that can be coated prior to the occurrence of flash rusting and/or oxidation. Remove any flash rust prior to coating, except as follows:

3.10.4.1 Surfaces cleaned by waterjetting must meet the applicable NACE/SSPC Standard for flash rust. For submarines, the first coat of epoxy primer must be applied within 24 hours of coating removal if removal is by non-automated waterjetting.

3.10.4.2 The water used in waterjetting must not include detergents or inhibitors without written approval from the coating manufacturer and the SUPERVISOR.

(I) or (I)(G) "SURFACE PROFILE" (See 4.4)

3.10.5 One profile measurement must be recorded for every 100 square feet for the first 500 square feet; for each additional 1,000 square feet or less, one profile measurement must be taken. Profile measurements must be taken in accordance with Method B or Method C of 2.8. For Method B of 2.8, one profile measurement must be the average (mean) of 10 individual readings. For profile measurements taken in accordance with Method C of 2.8, use profile tape suitable to read subject profile (i.e., coarse to extra-coarse plus). For Method C of 2.8, one profile measurement must be the average (mean) of 2 individual readings. If any individual reading is found to be greater than or equal to 5 mils, use Method B of 2.8 in those areas to determine existing profile. The retention of profile tape is not required. For areas listed in 3.7, document surface profile on QA Checklist Form Appendix 3 or Naval Shipyard QA Checklist Form Appendix 3 or 3A.

3.10.5.1 Following blasting or waterjetting operations, surface peak-to-valley profile must be checked. Surface profile must be validated on areas without visible pitting. For Method B of 2.8, each profile measurement must be between 2 and 4 mils. For Method C of 2.8, each profile measurement must be between 2 and 4 mils, with no individual tape reading less than one mil or greater than or equal to 5 mils. If such profile is not present, repair activity must establish the proper profile.

3.10.5.2 Following power tool cleaning to SSPC-SP 11 or SSPC-SP 15 of 2.5, surface profile must be checked. Profile measurements must be 2 - 4 mils for areas listed in 3.7 and submarine bilges and one - 4 mils for all other areas where accessible (inaccessible areas must be determined by inspection and agreed to by the SUPERVISOR).

3.10.5.3 For products without a NAVSEA-reviewed F718, manufacturer's instructions may be substituted.

3.10.5.4 Conversely, excessive use of mechanical tools (grinders, sanders, chippers, etc.) must be minimized to avoid metal loss. Overly aggressive blasting which causes metal thickness loss over the amount required for surface profile must also be avoided. Excessive depth of profile can cause problems with poor coating performance. A greater than recommended surface profile requires a paint film be applied to totally cover the profile to prevent pinpoint or flash rust. The increase in paint film thickness also increases the susceptibility of solvent entrapment, causing blistering and premature failure of the coating.

3.10.5.5 Due to the potential for excessive metal loss, for LCS 2 Class ships and SSN-21 and SSN-774 Class submarines, only the following power tools may be used to obtain an SSPC-SP 11 surface: needle guns, bristle blasters, and rotary peening tools. On LCS 2 Class ships and submarines, any areas of potential metal loss by corrosion or mechanical means must be documented and reported to the SUPERVISOR.

3.10.5.6 Recyclable Encapsulated Abrasive Media material conforming to SSPC-AB 4 may not establish a sufficient surface profile. If this method is employed and the profile is insufficient to meet the requirements, the repair activity must establish a sufficient surface profile.

3.10.5.7 Waterjetting will not establish a surface profile. If this method is selected by the repair activity and a surface profile does not exist or is insufficient to meet the requirements, the repair activity must establish a sufficient surface profile.

(I)(G) "CONDUCTIVITY MEASUREMENT"

3.10.6 For surfaces listed in 3.7 (excluding potable water and reserve feedwater tanks on submarines, and freshwater drain collecting tanks on aircraft carriers), accomplish the requirements for conductivity measurements as follows:

3.10.6.1 Following coating removal, accomplish conductivity measurements in accordance with the requirements of 3.10.6.3.

3.10.6.2 Additionally, accomplish a visual inspection within 4 hours prior to application of each coat. If evidence of contamination of the surface exists, accomplish the requirements of 3.10.6.3.

3.10.6.3 Accomplish surface conductivity checks using available field or laboratory test equipment on the freshly prepared surface. One reading must be taken for every 200 square feet for the first 1,000 square feet. One reading must be conducted for every additional 1,000 square feet or less. For immersed applications, such as tanks and bilges, conductivity measurements must not exceed 30 micro-siemens/cm. For non-immersed applications, conductivity measurements must not exceed 70 micro-siemens/cm. Conductivity samples must be collected using a product that meets the requirements of ANSI/NACE SP0508 of 2.9, "Methods of Validating Equivalence to ISO 8502-9 on Measurement of the Levels of Soluble Salts." Document on QA Checklist Form Appendix 4.

3.10.6.4 If a conductivity check fails, water wash (3,000–5,000 PSI) the affected areas with potable water. Dry the affected areas and remove all standing water. Accomplish surface conductivity checks on affected areas in accordance with 3.10.6.3. Repeat step until satisfactory levels are obtained.

3.10.6.5 If, after a freshwater wash, the measurements exceed required levels, a salt remover may be used; however, the only salt remover products that may be used for a coating system are those specified on that coating's NAVSEA-reviewed ASTM F718.

(I) or (I)(G) "SURFACE PREPARATION" (See 4.4)

3.10.7 Verify surface preparation for the coating systems specified in the Work Item or task order and Tables One through 8 are in accordance with 2.5 and 2.9. For areas listed in 3.7, document on QA Checklist Form Appendix 3 or Naval Shipyard QA Checklist Form Appendix 6.

3.10.7.1 For surface ships, surface cleanliness for dust must be accomplished for the underwater hull and documented on QA Checklist Form Appendix 5. Surface cleanliness for dust must meet Rating 2, Class 2, of 2.10. One dust tape reading must be taken for every 200 square feet for the first 1,000 square feet; for each additional 1,000 square feet or less, one tape reading must be taken. The tape reading requirement is waived if the final stage of surface preparation for the entire surface is UHP WJ.

3.10.7.2 When waterjetting has been performed to a specified WJ level of cleanliness on a steel surface, and the level of flash rust (low, moderate, or high) cannot be agreed upon between the authorized coating inspector and the Contractor through the use of the written NACE/SSPC WJ standard or the SSPC-VIS 4 visual reference standard, the procedure in Attachment B must be used to resolve the dispute.

3.10.7.3 The checkpoints of 3.10.5, 3.10.6, and 3.10.7 can be accomplished concurrently.

3.10.8 Coating systems must be applied and cured in accordance with this NAVSEA Standard Item and applicable NAVSEA-reviewed ASTM F718s as defined in 3.1.13.

3.10.8.1 For surface ship preservation of areas not listed in Tables One through 5, see the Tables in Section 1 of 2.2. For submarine preservation of areas not listed in Tables 6 through 8, see the Tables in 2.6.

3.10.8.2 Unless fully enclosed, (i.e., with containment), do not perform exterior paint application when sustained winds exceed 15 miles per hour (MPH).

(I) or (I)(G) "COATING INSPECTION FOR EACH COAT" (Consists of Coating Thickness, Holidays, and Cleanliness) (See 4.4)

3.10.9 Inspect each Prime, Intermediate, Stripe, Tack, Mist, and Top Coat (including Capastic) as follows:

3.10.9.1 Accomplish DFT measurements of each coat applied for the coating systems listed in Tables One through 8. This excludes any stripe coats and draft marks. For areas listed in 3.7, document on QA Checklist Form Appendix 7.

3.10.9.2 Accomplish a visual holiday check on each coat of the system. For areas listed in 3.7, document on QA Checklist Form Appendix 7. Any holiday found must be identified and touched-up. These touched-up holidays do not constitute a new coat. Paint containing Optically Active Pigment (OAP) must be visually inspected using violet light. Where an OAP primer is used, each primer and topcoat must be visually checked using violet light. When this occurs, the inspector must use a violet-light flashlight conforming to ASTM E2501 to enhance the normal visual inspection process. An ASTM E2501 flashlight produces violet light that activates the fluorescent OAP. The inspector must wear yellow or amber-tinted glasses that block ultraviolet and violet light to accomplish the inspection. See ASTM E2501 for the light transmittance specification for tinted glasses and <http://www.nstcenter.biz> for a list of safety eyewear models that meet the specification. Guidance regarding OAP inspection practices is available in SSPC-TU 11.

3.10.9.3 Accomplish a visual inspection for surface cleanliness. If evidence of contamination exists, accomplish degreasing/cleaning a maximum of 4 hours prior to application of next coat to ensure removal of surface contaminants. For areas listed in 3.7, document on QA Checklist Form Appendix 7 or 7A or Naval Shipyard QA Checklist Form Appendix 6 or 7. If condition is UNSAT, then also use Appendix 2 or Naval Shipyard QA Checklist Form Appendix 6.

3.10.9.4 Accomplish a visual inspection for chloride or other contamination for areas listed in 3.7 (excluding potable water and reserve feedwater tanks on submarines, and freshwater drain collecting tanks on aircraft carriers). If evidence of chloride or other contamination exists, accomplish requirement of 3.10.6.4 on the affected area(s) approved by the SUPERVISOR, a maximum of 4 hours prior to application of next coat to ensure removal of surface contaminants. Document on QA Checklist Form Appendix 7 or 7A or Naval Shipyard QA Checklist Form Appendix 6 or 7. If condition is UNSAT, then also use Appendix 4 as required in 3.10.6.3 to 3.10.6.5.

3.10.9.5 For MIL-PRF-23236 Type VII coatings, runs, drips and sags may appear. In areas where DFTs of runs, drips, and sags are 50 mils or less, no action is required; areas with DFTs in excess of 50 mils must be assessed by the SUPERVISOR.

3.10.10 For DFT readings required in 3.10.9.1, DFT readings for each coat must be taken in accordance with Method PA 2 of 2.5. When measuring full coats to determine total system thicknesses denoted in Tables One through 8, DFT readings must not be taken in areas where stripe coatings have been applied. When scanning technology is used in accordance with SSPC-PA 2 Appendix 10, the average DFT displayed in each batch will be recorded in Appendix 7.

3.10.10.1 WFT readings are required in lieu of DFT readings for any coat that must be in a tacky state (as defined in 3.6.3) when the next coat is applied, for non-metallic surfaces, for anti-corrosive and antifouling paint applied over Capastic and sprayable shields, and when applied over existing coatings. For metallic surfaces, the number of WFT spot readings must be 2 readings per 1,000 square feet. For non-metallic surfaces, the number of WFT spot readings must equal the number of DFT readings that would have been taken. When WFT readings are used in this manner, the sampling frequency, distribution, and acceptance criteria must be the same as described in SSPC-PA 2 of 2.5, except that only one WFT reading is required to represent a "spot measurement" instead of the three "gauge readings" defined in SSPC-PA 2. WFT equals DFT divided by percent solids by volume (when percent solids by volume is expressed as a decimal, i.e., 60 percent equals 0.60). For areas listed in 3.7, document on QA Checklist Form Appendix 7A or Naval Shipyard QA Checklist Form Appendix 7.

3.10.10.2 If any coat measures less than its specified DFT, apply an additional coat of that product. The total DFT of these 2 coats must not exceed the specified maximum thickness for the original coat as specified in Tables One through 8. If an additional coat is required, accomplish a cleanliness checkpoint in accordance with 3.10.9.3 prior to application of the additional coat.

3.10.10.3 During paint application, a WFT gauge must be used to verify the application of proper paint thickness for each coat of all coating systems listed in Tables One through 8. WFT readings must be taken to confirm this, but need not be recorded.

3.10.10.4 Except to remediate small, localized drips or sags totaling less than 0.03 percent of the coated area, excessive DFT must not be sanded to reduce DFT without approval of the SUPERVISOR.

3.10.10.5 MIL-PRF-23236 Type VII paints require additional DFT readings to be performed in accordance with Attachment A. These readings must be performed following the last coat of MIL-PRF-23236 Type VII paint on the areas where the stripe coat would have been applied.

3.10.11 With the exception of potable water, reserve feedwater, and freshwater drain collecting tanks, when performing QA inspections for holidays and DFT readings, for all areas where aesthetics are not an issue, permanent markers, as approved by the SUPERVISOR, are acceptable. These markings may be directly overcoated with the next coat of paint (or remain exposed if used on the final coat in an area where aesthetics are not an issue).

3.11 NONSKID. Except for peel and stick nonskid, which must have preservation operations as specified in 3.10, accomplish preservation operations for surface ship nonskid systems in accordance with the following:

3.11.1 When installing nonskid systems to critical coated areas (listed in 3.7) within enclosed spaces, including exterior temporary structures for environmental control, the following conditions must be maintained for a minimum of 48 hours after application of each coat of the nonskid system:

3.11.1.1 Maintain sufficient volumetric air changes to satisfy 2.3 requirements that ventilation be provided in sufficient quantities to keep the concentration of coating solvent vapors below ten percent of their lower explosive limit.

3.11.1.2 Continuously maintain airflow into and out of the enclosed space to satisfy the requirements of 2.3. Fully open hangar doors satisfy 2.3 requirements.

3.11.1.3 Orient input air such that airflow is directed towards or across the deck and in the direction of the exhaust ventilation ports. Locate exhaust ventilation ports such that the bottom of the exhaust duct/opening is less than one foot from the deck surface to ensure that “heavier than air” coating solvent vapor is effectively removed from the enclosed space.

3.11.1.4 Evenly distribute input and exhaust ports such that uniform air movement throughout the enclosed space and across deck surface is maintained. Ensure airflow is not “short circuited” from input to exhaust by maximizing distance between input and exhaust ports.

3.11.1.5 Ensure the ventilation system remains operational and powered throughout application of the nonskid system regardless of whether personnel are in the enclosed space.

3.11.2 Accomplish the requirements of 3.10.1 (environmental) with the following additions:

3.11.2.1 Record ambient and substrate surface temperatures, relative humidity, and dew point readings at one-hour intervals during nonskid system application.

3.11.2.2 Unless fully enclosed (i.e., with a tent), do not apply nonskid primer when sustained winds exceed 15 MPH.

3.11.2.3 Unless the applicable NAVSEA-reviewed ASTM F718 is more stringent, ambient air temperature must be 55-100 degrees Fahrenheit, deck temperature for primer application must be 40-120 degrees Fahrenheit, and deck temperature for nonskid application must be 40-110 degrees Fahrenheit. Deck temperature must be a minimum of 5 degrees Fahrenheit above the dew point for nonskid system application. For application of Type VIII (low temperature) nonskid systems, ambient air and deck temperatures must be between 35 degrees Fahrenheit and the upper limit specified by the NAVSEA-reviewed ASTM F718.

3.11.2.4 Environmental requirements will be documented in accordance with paragraph 3.7.1.

3.11.3 Accomplish the requirements of 3.10.2 through 3.10.4 with the following additions:

3.11.3.1 If cleaning is performed via solvent wiping, after solvent wiping, the deck must be allowed to dry before application of any coating. No visible solvent must be present on deck surfaces prior to proceeding with the next process step. Solvent wiping is defined in 3.6.5.

3.11.3.2 When a solvent wipe is performed, annotate Appendix 2 or Naval Shipyard QA Checklist Form Appendix 6 with type of solvent and time allowed to dry.

3.11.3.3 When cleaning exterior nonskid decks with High Pressure Water Cleaning (HP WC), cleanliness must meet the requirements of SSPC-SP WJ-4/NACE WJ-4 instead of SSPC-SP 1.

3.11.3.4 For tie-downs prepared to SSPC-SP 2, 3, or 15 of 2.5, the initial SSPC-SP 1 is waived if the final stage of surface preparation is UHP WJ in accordance with NACE/SSPC-SP WJ-2 of 2.5 and 2.9.

(I) or (I)(G) "SURFACE PROFILE" (See 4.4)

3.11.4 Following blasting or waterjetting operations, surface peak-to-valley profile must be checked. Surface profile must be validated on areas without visible pitting. Accomplish the requirements of 3.10.5 for surface profile measurements. For Method B of 2.8, each profile measurement must be between 3 and 6 mils. For profile measurements taken in accordance with Method C of 2.8, use profile tape suitable to read subject profile (i.e., coarse to extra-coarse plus). For Method C of 2.8, one profile measurement must be the average (mean) of 2 individual tapes. For Method C of 2.8, each profile measurement must be between 3 and 6 mils, with no individual tape reading less than 2.5 mils or greater than, or equal to 5 mils. If any individual tape reading is found to be greater than, or equal to, 5 mils, use Method B of 2.8 in those areas to determine existing profile. If such profile is not present on decks and aircraft elevators, repair activity must establish proper profile. The maximum profile requirement is waived for carrier aircraft elevators prepared via waterjetting. The maximum profile requirement is 7 mils on aluminum aircraft elevators and CG-47 class flight decks when prepared by abrasive blasting. The retention of profile tape is not required. For areas listed in 3.7, document on QA Checklist Form Appendix 3 or Naval Shipyard QA Checklist Form Appendix 3 or 3A.

3.11.4.1 For nonskid areas that abrasive blast equipment or waterjet equipment cannot access, substrate must be prepared to SSPC-SP 11. Profile must be 2 – 6 mils where accessible. Underside of tie-downs must be prepared to SSPC-SP 2 or SSPC-SP 3 of 2.5; however, feathering requirements of 3.6.4 are waived, while remainder of tie-down must be prepared to SSPC-SP 15 of 2.5.

3.11.4.2 The requirements of 3.10.5.4 through 3.10.5.6 apply to nonskid systems.

3.11.5 Accomplish the requirements of 3.10.6 for conductivity measurements.

3.11.6 Accomplish the requirements of 3.10.7 for surface preparation.

3.11.6.1 Surface cleanliness for dust must be accomplished for nonskid flight decks and documented on QA Checklist Form Appendix 5. Surface cleanliness for dust must meet Rating 2, Class 2, of 2.10. Three individual readings must be taken every 100 square feet for the first 500 square feet. If the tape readings are consistent, only one tape reading must be taken for every 1,000 square feet remaining. The tape reading requirement is waived if the final stage of surface preparation for the entire surface is UHP WJ and the primer is applied within 6 hours of completion of surface preparation. If the primer is not applied within 6 hours of the last surface cleanliness for dust test, the tape readings must be accomplished for all surface preparation methods.



3.11.6.2 For flight deck areas, not to include aircraft elevator platform decks, receiving a nonskid system and prepared to NACE/SSPC-SP WJ-2, a minimum of 20 percent of the total area receiving a nonskid system must be abrasively blasted to an NACE 2/SSPC-SP 10 level of cleanliness. The areas to be prepared to NACE 2/SSPC-SP 10 must be as directed by the SUPERVISOR.

3.11.7 Nonskid systems must be applied in accordance with the applicable Tables. A new nonskid system must overlap existing nonskid system to the minimum extent necessary to create a continuous film as agreed upon by the SUPERVISOR.

3.11.7.1 Nonskid must be rolled parallel to ship's main axis. Welds parallel with the direction of peaks and valleys must be cross-rolled. Cross-rolling must extend 3 to 6 inches on each side of the weld. The requirement to roll nonskid parallel to the ship's main axis is waived on LCS 2 class flight decks and any other areas with extruded aluminum plank decks as approved by the SUPERVISOR. In these areas, nonskid must be rolled perpendicular to the ship's main axis.

3.11.7.2 Nonskid material remaining in the can after nonskid is poured onto primed deck surface must not be removed from the can.

3.11.7.3 If probing the nonskid surface with a dull putty knife results in penetration of the putty knife into the nonskid, neither foot nor vehicular traffic must be permitted.

3.11.7.4 DFT measurements of nonskid primer in overlap areas must be no more than 15 mils.

3.11.8 Accomplish the requirements of 3.2 for stripe coat with the exception that stripe coat may precede prime coat.

3.11.8.1 For overcoating of stripe coat or stripe coating of the primer coat, refer to the applicable NAVSEA-reviewed ASTM F718. When the stripe coat is applied prior to overcoating with a full coat of primer, the stripe coat must be dry to touch in accordance with ASTM D1640.

3.11.8.2 A second full coat of proprietary nonskid primer listed on the QPL for MIL-PRF-24667 may be applied if approved by the SUPERVISOR. The second full coat satisfies the stripe coat requirement.

3.11.9 Nonskid application must begin within 36 hours of completion of the final full primer coat or the mist coat application. For areas not listed in 3.7, nonskid overcoating application must be in accordance with NAVSEA-reviewed ASTM F718. For areas listed in 3.7, use the following:

3.11.9.1 If nonskid application begins within 36 to 72 hours after completion of final full primer coat application, the primer coat must be solvent wiped with solvent required by the NAVSEA-reviewed ASTM F718.

3.11.9.2 If nonskid application begins within 3 to 7 days after completion of final full primer coat application, the primer coat must be solvent wiped with solvent required by the NAVSEA-reviewed ASTM F718, then lightly abraded, solvent wiped again, and a mist coat (one to 2 mils) of primer must be applied and allowed to cure to recoat.

3.11.9.3 If the primer coat is not overcoated with nonskid within 7 days of final full primer coat application, the primer must be removed and the surface preparation repeated. For zone tie-in areas where the primer is to be overcoated with itself (up to 12 inches of overlap), the recoat window must be in accordance with the NAVSEA-reviewed ASTM F718; the primer must be solvent wiped with solvent required by the NAVSEA-reviewed ASTM F718, then lightly abraded, then solvent wiped again.

3.11.9.4 Aircraft carrier landing areas not overcoated with nonskid within 72 hours of primer application completion must have surface preparation repeated.

3.11.10 Accomplish the requirements of 3.10.9 through 3.10.11 for inspection of nonskid primer (full and stripe coats).

(I) or (I) (G) "NONSKID MIXING AND APPLICATION" (See 4.4)

3.11.11 Accomplish the following requirements during initiation of the mixing and application process:

3.11.11.1 Visually verify that nonskid mixing blade is free of previously cured coatings, contaminants, or rust.

3.11.11.2 Verify that applicator meets NAVSEA-reviewed ASTM F718 mixing and application requirements, including: specified mixing equipment, pre-mix time, mix time, induction time, pot-life and any product specific application requirements.

(I) or (I) (G) "NONSKID SPREAD RATE AND HOLIDAY INSPECTION" (See 4.4)

3.11.12 Verify that nonskid spread rate meets the following requirement: Types I, V, VI, VII, and VIII - 18 square feet/gallon minimum and 30 square feet/gallon maximum; Types II, III, IX and X - 23 square feet/gallon minimum and 35 square feet/gallon maximum; and, Types IV and X (sprayed) - 40 square feet/gallon minimum and 60 square feet/gallon maximum. The minimum spread rate for Types IV and X (sprayed) must be in accordance with the manufacturer's NAVSEA-reviewed ASTM F718. Perform visual holiday inspection of nonskid and document on QA Checklist Form Appendix 7. Spread rate must be determined by the following formula:  $[(\text{square feet coated}) / ((\text{gallons per kit}) \times (\text{number of kits}))]$ .

3.11.12.1 Holidays less than 4 square inches must be touched-up as follows: 1) solvent clean primer with solvent required in product NAVSEA-reviewed ASTM F718, 2) lightly sand exposed primer, 3) solvent clean sanded surface with solvent required in product NAVSEA-reviewed ASTM F718, and 4) apply nonskid to primer to approximate texture of surrounding nonskid. Overcoat window restrictions do not apply to touch-up of holidays in non-landing areas. Holidays less than 1/8 of a square inch must be exempt from touch-up.

3.11.13 Inspect the location and color of required VLA markings in accordance with Naval Air Warfare Center Aircraft Division (NAWCAD) Class Guidance Drawings, Air Capable Ship Aviation Facilities Bulletin, Amphibious Assault Ship Aviation Facilities Bulletin, Shipboard Aviation Resume (NAEC-ENG-7576), VLA General Service Bulletin No. 8 (latest revision) or by contacting the local NAWC (CAFSU/ASIR) Field Office.

3.12 For submarines, accomplish preservation of damping and acoustic tiles and surfaces in way of these tiles in accordance with the following. All exterior tiles and tiles inside tanks must be installed over a surface prepared to NACE 2/SSPC-SP 10 and painted with the preservation system indicated in Table 8. Surfaces beneath exterior tiles and tiles inside tanks are considered critically coated. Care must be taken to ensure blasting does not damage tiles.

Surface preparation and preservation of steel restrained tiles must be as listed in Table 8. Paint only steel portions of SSBN/SSGN-726 Class acoustic baffles. Before overcoating tile that is currently coated, sweep blast the surface to roughen the existing paint. Non-steel restraining covers are not required to be painted except for antifouling purposes. Overspray of otherwise unpainted covers is acceptable. Full paint out of non-steel damping restraining covers, unrestrained damping, and acoustic tile (including Gradual Transition Coating) and covers is not intended. In interior spaces, exposed surfaces of acoustical absorptive treatments that are painted must be prepared to SSPC-SP 1 and must be painted with 1-2 mils of paint (avoid filling perforations) to match surroundings.

#### 4. NOTES:

4.1 Wet space decks include sanitary spaces (washrooms, water closets, and showers), food service spaces (galley, scullery, butcher shop, bakery, meat prep rooms, and food service line), and trash compactor rooms.

4.2 Total DFT encountered during removal may exceed specified Table thicknesses.

4.3 Total removal of ablative coating is not required. An ablative antifoulant (AF) coating system must not be removed by blasting prior to its specified service life unless it is blistered, peeling, or otherwise damaged beyond repair. Stable and intact ablative AF coatings must be retained and overcoated. The total film thickness of the combined retained and freshly applied paint must comply with Table One/Table 6. When the Work Item or task order calls for overcoating of retained intact ablative AF coating, AF surfaces must be washed down with fresh water. For all ships except submarines and aircraft carriers, this fresh water washdown must be performed at 2,000 PSI as the vessel comes out of the water, in order to prevent slime and oxidized paint from drying on the hull and inhibiting leaching of the paint when the ship is returned to the water. For submarines and aircraft carriers, instead, within 24 hours of the hull being released by cognizant shipyard authorities, pressure wash with fresh water between 2,000 and 5,000 PSI. The surface must be cleaned and dried before new paint is applied. Apply any anti-corrosive (AC) paint to areas in need of repairs. Overcoat the AC paint with the approved AF paint of the same MIL-PRF-24647 Type. The Work Item or task order will specify the degree of removal.

4.4 The paragraphs referencing this note are considered an (I)(G) if the inspection/test is on a critical surface as listed in 3.7. If the inspection/test is not on a surface listed in 3.7, then the paragraph is considered an (I).

4.5 Refer to 009-03 of 2.1 as appropriate for requirements concerning potential exposure to toxic or hazardous substances and hazardous operations.

4.6 The repair activity may use environmental enclosures to control environmental conditions.

4.7 Preservation system repairs are an Unrestricted Operations (URO) Maintenance Requirement Cards (MRC) program attribute.

4.7.1 The Unrestricted Operations (URO) Maintenance Requirement Cards (MRC) program was developed by NAVSEA to monitor specific areas of interest to determine if the conditions of these areas are suitable for continued unrestricted operations. Maintaining the protective capability of the coating system is critical to maintaining structural integrity during the periods between inspections. For this reason, complying with requirements for coating system application for all aspects of the preservation process is essential. Other systems that impact the

URO MRC program are Special Hull Treatment (SHT) application process, including Mold-In-Place (MIP), maintenance of cathodic protection systems (Impressed Current Cathodic Protection (ICCP) and anodes) and installation of various types of tiles (acoustic, damping, etc.).

4.7.1.1 Substrate preparation and preservation are not authorized/covered in this Standard Item for vertical launch system (VLS) bathtub area, thin line towed array (TLTA) interior, surfaces covered by SHT, propulsor, and retractable bow plane recesses on submarines.

4.7.2 Preservation work in submarine tanks and enclosed spaces is usually scheduled to occur when the tanks and spaces are opened and entered to perform URO MRC structural inspections. Any time a tank or other enclosed space is entered, if a URO MRC 003 structural inspection is not authorized, an inspector qualified in accordance with URO MRC 003 will perform a structural visual examination.

4.7.3 Any URO MRC item being blasted and painted will have a URO MRC hull survey inspection performed by an inspector qualified in accordance with URO MRC 003 prior to blasting and again prior to repainting.

4.8 Painting of rubber piece parts of pipe hangers is permitted in the following areas: Main Ballast Tanks (MBTs), freeflood areas, and internal tanks which are normally painted. The rubber piece parts include the liners, grommets, and inserts found in steel strap and steel block type pipe hangers; also included is the block rubber type pipe hangers. Prior to painting rubber piece parts in surface ship potable water and reserve feedwater tanks, existing paint must be removed to an SSPC-SP 2 level of cleanliness as approved by the SUPERVISOR. Do not paint rubber piece parts in surface ship FWDCTs, submarine RFTs, and hangers on nuclear piping that traverses other non-nuclear tanks.

4.9 Inspections such as URO inspections and inspection periodicities are addressed in 2.2 and 2.6.

4.10 For peel and stick nonskid, interior and exterior applications on surface ships in 3.1.27; Category II Standard Item 009-26 "Deck Covering Requirements; accomplish", including Attachment G will be specified in the work item.

4.11 Unless otherwise noted, aircraft carriers, and boats and small craft are considered surface ships throughout this document. The tables are split up between surface ships and submarines. Table One is for surface ship underwater hull areas. Table 2 is for surface ship exterior areas. Table 3 is for surface ship interior spaces. Table 4 is for surface ship tanks and voids. Table 5 is for surface ship miscellaneous areas. Table 6 is for submarine exterior hull areas. Table 7 is for submarine interior areas. Table 8 is for submarine tanks and voids.

4.12 The repair activity must not coat reactor plant items cited in the ship's reactor plant paint schedule in accordance with this Standard Item.

## ATTACHMENT A

### Edge DFT Measurement

In addition to the required DFTs per SSPC-PA 2, a separate set of “edge” DFT readings must be taken in close proximity to corners and edges of area structural elements including, but not limited to stiffeners, “rat holes,” cut-outs, and frames. This data must be taken in accordance with SSPC-PA 2 and reported separately from those required by 3.10.9.1, with the following modifications:

1. The “edge” gauge readings must be taken approximately ¼ inch (i.e., 0.5 cm) from edges using micro-probe gauges with a probe less than or equal to ½-inch in diameter. For “edge” readings taken on substrates less than ½ inch thick, readings must be taken from the “middle” of the substrate. Microprobe gauges must be calibrated, in accordance with manufacturer’s direction, to measure paint thicknesses expected during application.
2. Welds not associated with corners or edges (i.e., a butt weld joining 2 flat plates) must be inspected using standard visual techniques. The inherent roughness of the weld precludes the collection of reproducible data from these areas. Inspectors may, if they choose, take a spot reading within ¼ inch (i.e., 0.5 cm) from a butt weld.
3. An "edge" spot measurement must consist of 3 gauge readings taken within a 1.5 inch (i.e., 4 cm) diameter circle. Accomplish front, back, and edge DFT gauge readings as shown in Figure A-1 (see attached). For each data set required for the flat surface data set the equivalent is required for the edge or corner data set. For example, if 20 spot DFT measurements are required for an area, then 20 DFT measurements are required using the front, back, edge method set and 20 for the flat surface set.

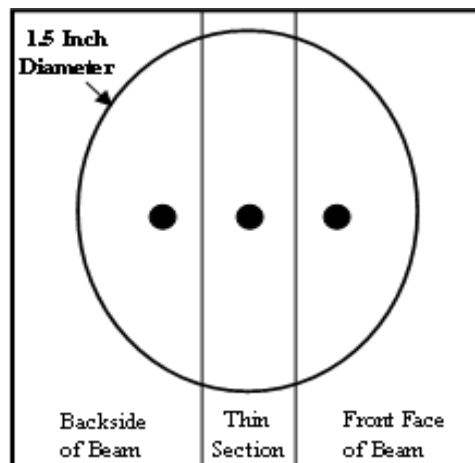

Figure A-1

## ATTACHMENT B

### NAVSEA Flash Rust Adjudication Procedure:

When waterjetting has been performed to a specified WJ level of cleanliness on a steel surface, and the level of flash rust (low, moderate, or high) cannot be agreed upon between the authorized coating inspector and the Contractor through the use of the written NACE/SSPC WJ standard or the SSPC-VIS 4 visual reference standard, the following procedure must be used to resolve the dispute. Note that this procedure is not a substitute for the definitions contained in the NACE/SSPC standard, but rather is intended to provide objective quality evidence (OQE) that a disputed zone, surface, or area has a low, moderate or high level of flash rust.

1. Ensure Surface Condition. The zone, surface, or area must have been cleaned to the required waterjetting level of cleanliness in accordance with 2.5 and 2.9 and possess a level of flash rust that cannot be readily gauged or appraised with certitude using the guidelines of 2.5, 2.9, and SSPC-VIS 4 alone.
2. Determine Minimum Number of Samples. One flash rust reading (consisting of one test measurement and one control measurement) must be taken for every 200 square feet for the first 1,000 square feet of a zone, surface, or area. For each additional 500 square feet or increment thereof, one additional flash rust reading must be taken.

#### CAUTION

Excessive pressure applied to the tape can crack the slide and create a dangerous, sharp surface.

3. Prepare Test Sample and Control Sample. Both the test and control samples are prepared by applying a 4-5 inch long piece of ISO 8502-3 dust tape to a 1.2 mm thick clean, clear microscope slide which is 50mm by 75mm or larger. The tapes for the test and control samples must be prepared as described in the sub-paragraphs below. Fully adhere the adhesive side of the tape to the slide, centering the tape's length over the 75mm dimension of the glass. To help secure the tape to the slide, not more than 1/4 inch of the tape end may be wrapped under the slide. Additional tape may interfere with the measuring devices. Any sample with air bubbles larger than 1/4 inch in diameter must be rejected. Using a permanent marker to write on a non-test portion of the slide, date and uniquely identify each sample.

3.1 Test Sample Tape Preparation. For each test sample, the dust tape is applied to a representative area of the flash rusted surface before being applied to the microscope slide. The inspector must rub the tape onto the flash rusted surface with his/her thumb or other finger, pressing as hard as possible over the central 3 inches of the tape without damaging it. Remove the tape from the steel in a manner that retains as much of the adherent rust as possible; do not shake the tape or try to dislodge the rust.

ATTACHMENT B  
(Con't)

3.2 Control Sample Tape Preparation. While avoiding transferring fingerprints to the central 3 inches of tape, apply a control piece of tape from the same roll as that used for the test sample to a separate clean, clear microscope slide.

4. Measure Transmittance. For each test and control tape/microscope-slide assembly, measure the transmittance using a Laser Labs Model LM100, Monroe PMP Model PD2.1, Monroe PMP Model PD3.0, or NAVSEA-approved equivalent transmittance measurement meter. Transmittance measurements must not be made in direct sunlight or in an area where the ambient light level exceeds 100 foot candles. Insert the slide into the instrument with the tape facing the meter's light source. Record two measurements from different locations on the test sample. Record 2 measurements from the control tape, taking one measurement from each end. Subtract the average of the 2 test readings from the average of the two control readings. The difference in average transmittance of the test sample (i.e., sample with flash rust) and the average transmittance of the control sample must constitute one transmittance reading.

5. Adjudicate Flash Rust Level. A difference in transmittance reading (i.e., control minus test sample) must be applied to the entire zone, surface, or area which the measurement is intended to represent. The percentage difference between the average control and test sample values, as compared to the control sample, must be used to establish the following flash rust levels:

WJ "High" level of flash rust: greater than 20 percent difference in transmittance readings.

WJ "Moderate" level of flash rust: 10 percent to 20 percent difference in transmittance readings.

WJ "Low" level of flash rust: less than 10 percent difference in transmittance readings.

If the adjudicated flash rust level is determined to be greater than the requirements for the area allow, then the area must be re-cleaned until the specification is met.

6. Retain Samples. All test transmittance samples and control transmittance samples must be retained as objective quality evidence that the required level of surface cleanliness was obtained.

## ATTACHMENT C

### Process for Spot and Sweep Blast of the Underwater Hull and Freeboard

1. The "Spot and Sweep" method must only be used if authorized by the SUPERVISOR prior to the start of work in these areas. The use of this Spot and Sweep process must only apply to the underwater hull and freeboard areas of the ship and may only be considered for use on surface ships.
2. The spot and sweep blast process must be performed by a robotic crawler unit that uses UHP WJ. For areas not accessible by the robotic crawlers, UHP lances and/or abrasive blasting may be used to create either a NACE/SSPC-SP WJ-4/M surface or an SSPC-SP 7 surface, respectively. SSPC-SP 3 power tool cleaning may be used for feathering in the spot and sweep-prepared surfaces.
3. Examine the existing coating on the ship's hull and determine the color sequence of the current epoxy coating system prior to blasting. The anticipated sequence is red epoxy primer followed by gray epoxy tie coat. The examiner must note these colors for use during inspection of the hull prior to application of the first coat of epoxy primer.
4. The UHP robotic crawler unit must be set up to accomplish the following:
  - (a) Remove all loose and degraded coating, rust and fouling from areas of bare metal to create a NACE/SSPC-SP WJ-2/M surface.
  - (b) For the underwater hull: Remove all antifouling coating and remove approximately 1/2 of the thickness of the current MIL-PRF-24647 epoxy tie coat from the underwater hull area.
  - (c) For the freeboard portion of the hull: Remove all of the MIL-PRF-24635 coating, regardless of thickness, and remove approximately 1/2 of the thickness of the top MIL-PRF-24647 or MIL-PRF-23236 epoxy coat from the freeboard area.
  - (d) Smoothly feather or transition from areas of bare metal to the retained epoxy coating. Areas of sharp or "step" transition between bare metal and paint must be noted on the applicable QA appendix form in the comments section. Also, feather edges as needed where the UHP robotic crawler leaves behind markings in the existing paint (concentric circles).
5. The use of the Spot and Sweep method does not waive any surface preparation QA steps. Conduct all QA inspections on bare metal areas and record QA data. Areas of retained paint must be visually inspected and must satisfy the following:
  - (a) There must be no more than two colors of paint visible in any area of retained coating. Inspectors must observe the red primer adjacent to any bare metal areas and then continue observations into the bulk of the retained epoxy. Gray epoxy may be retained on top of the red primer, but any visual evidence of additional coats of red or black paint (indicating antifouling coating retention) or haze gray MIL-PRF-24635 (indicating silicon alkyd/polysiloxane coating retention) on top of the gray epoxy must be cause for closer inspection. Closer inspection must be conducted from a minimum distance of 3 feet. Upon closer inspection, a solvent-wipe test with a white rag must be conducted using an antifouling coating clean-up solvent. If the solvent wipe test shows color transfer onto the rag, the area must be rejected. Rejected areas must be cleaned again until no color transfers to the rag.



(b) Minimize areas of sharp transition or steps between bare metal and paint. Any such areas must be inspected and tested with a dull putty knife to determine adhesion. If the paint flakes or can be dislodged, the area must be rejected and cleaned again to remove the loose paint.

(c) Feather the transition areas where partial blasted areas occur next to bare steel blasted areas. Sharp edges must be removed in accordance with SSPC-SP 3 and the areas feathered for a smooth transition.

6. The first step of the coating application process must be as follows: Apply one coat of epoxy primer in accordance with Tables One and 2 to all areas in the zone or work area (i.e., both bare metal and retained epoxy primer) to achieve the specified epoxy coating thickness. Do not apply a thin or varied primer thickness when traversing areas between bare metal and retained epoxy.

7. Coating inspections must be performed for each coat of paint in accordance with 3.10.9. In bare metal areas, DFT readings must be measured and recorded. In areas of retained paint, however, WFT readings must be measured and recorded in place of DFT readings for determining proper coating thickness for each coat. (Follow the requirement for taking WFT readings in place of DFT readings for accept/reject criteria). In areas of retained paint, DFT readings must still be measured and recorded. However, high DFT readings must not be cause for rejection; such readings must only be measured for documentation purposes.

8. Once the primer has reached the cure to overcoat state, the surface area must be inspected for edge lifting of the remaining epoxy that was overcoated. This inspection must be conducted at a maximum distance of 15 feet. As it cures, the epoxy primer may lift any loose edges of the existing coating that may not have been visible during the initial surface preparation inspection. Any areas where the paint has lifted must be prepared in accordance with SSPC-SP 3 and primed. This inspection may be included as part of the DFT/WFT and visual holiday inspection.

9. For underwater hull areas:

(a) Apply second / tie coat of epoxy and first coat of antifouling in accordance with Table One.

(b) Apply remaining antifouling system in accordance with Table One.

10. For freeboard areas, apply second coat of epoxy then the topcoat in accordance with applicable Line in Table 2.

## ATTACHMENT D

### ICCP Sprayable Dielectric Shields Application Instructions For Removed/New Anode Installation

1. Prior to surface preparation, remove existing anode. If new installation, install gland body and anode mounting studs.
2. Install plug or masking material for the protection of areas not to be painted to include sea chests and other areas as directed by the SUPERVISOR.
3. Prepare surface in accordance with requirements listed in the Table and Line for “Dielectric Shields” and QA checkpoints are conducted in accordance with 3.7.
  - a. For 8 foot anode, prepare area 15 feet by 22 feet in accordance with Figure D-1.
  - b. For 4 foot anode, prepare area 15 feet by 18 feet in accordance with Figure D-1.
  - c. For 2 foot anode, prepare area 15 feet by 16 feet in accordance with Figure D-1.

NOTE: All coatings must be listed in the Table and Line for “Dielectric Shields” and be applied in accordance with their NAVSEA-reviewed ASTM F718. All QA checkpoints must be conducted in accordance with 3.7.

4. Apply primer to at 10 – 12 mils DFT. Exclusive of specified DFT range, the primer must be mixed and applied in accordance with the manufacturer’s NAVSEA-reviewed ASTM F718.

NOTE: Intermediate and topcoat cannot be applied at required thickness in single pass without significant runs and sags. To prevent application defects, apply coatings in two passes as instructed below.

5. Within the primer’s specified overcoat window, apply the first pass of the intermediate coat at a thickness between 13 and 18 mils. The intermediate coat must be applied to the anode area within 5 to 7 inches of the primer boundary, leaving a 5 to 7 inch band of primer along the perimeter.
  - a. For 8 foot anode, coat area 14 feet by 21 feet in accordance with Figure D-1.
  - b. For 4 foot anode, coat area 14 feet by 17 feet in accordance with Figure D-1.
  - c. For 2 foot anode, coat area 14 feet by 15 feet in accordance with Figure D-1.
6. Within 5 minutes of completion of the first pass, begin applying the second pass of intermediate coat at 30 – 45 mils.

7. Within the intermediate coat's specified overcoat window, apply the first pass of topcoat coat at a thickness between 13 and 18 mils in a contrasting color. The topcoat must be applied to the anode area within 5 to 7 inches of the intermediate coat boundary, leaving a 5 to 7 inch band of intermediate coat along the 5 to 7 inch band of primer.
  - a. For 8 foot anode, coat area 13 feet by 20 feet in accordance with Figure D-1.
  - b. For 4 foot anode, coat area 13 feet by 16 feet in accordance with Figure D-1.
  - c. For 2 foot anode, coat area 13 feet by 14 feet in accordance with Figure D-1.
8. Within 5 minutes of completion of the first pass, begin applying the second pass of topcoat at 30 – 45 mils.
9. Allow topcoat to cure for minimum recoat time and ensure the total coating system meets the required 70 mils minimum DFT and does not exceed 100 mils within the footprint of the anode.
10. Remove plugs and masking material from step 2.
11. Apply a 1/8 inch bead of MIL-A-46106 room-temperature vulcanizing (RTV) silicone adhesive-sealant to neoprene mat around each stud holes leaving 1/2 inch clearance from the edge of the hole and around the edge of the entire mat, again leaving 1/2 inch clearance from the edge.
12. Place neoprene mat on hull (RTV silicone adhesive-sealant side towards the hull), leaving equal clearance around all studs and the gland socket.
13. Insert anode into the socket.
14. While holding the anode in place, apply RTV silicone adhesive-sealant around each stud up to the bottom of the counterbore.
15. Install the nuts handtight, then from the center out, torque the nuts to between 8 and 10 foot-pounds.
16. Apply RTV silicone adhesive-sealant up to the top of the counterbore and insert anode cap. Allow the RTV silicone adhesive-sealant to cure to service.
17. Protect the face of the anode, ensuring all of the platinum surfaces are covered to prevent damage.
18. Within the topcoat's specified overcoat window, apply the underwater hull coating system over the entire dielectric shield area.

19. Remove masking from step 17.

Note: For dielectric shield coatings, follow the NAVSEA-Reviewed ASTM F718 for temperatures, cure, and recoat times, regardless of applied per coat DFT. If any overcoat windows are breached, standard recovery methods apply – hand sand with 80 grit sandpaper to degloss, then solvent wipe to SSPC-SP 1 cleanliness and continue painting.

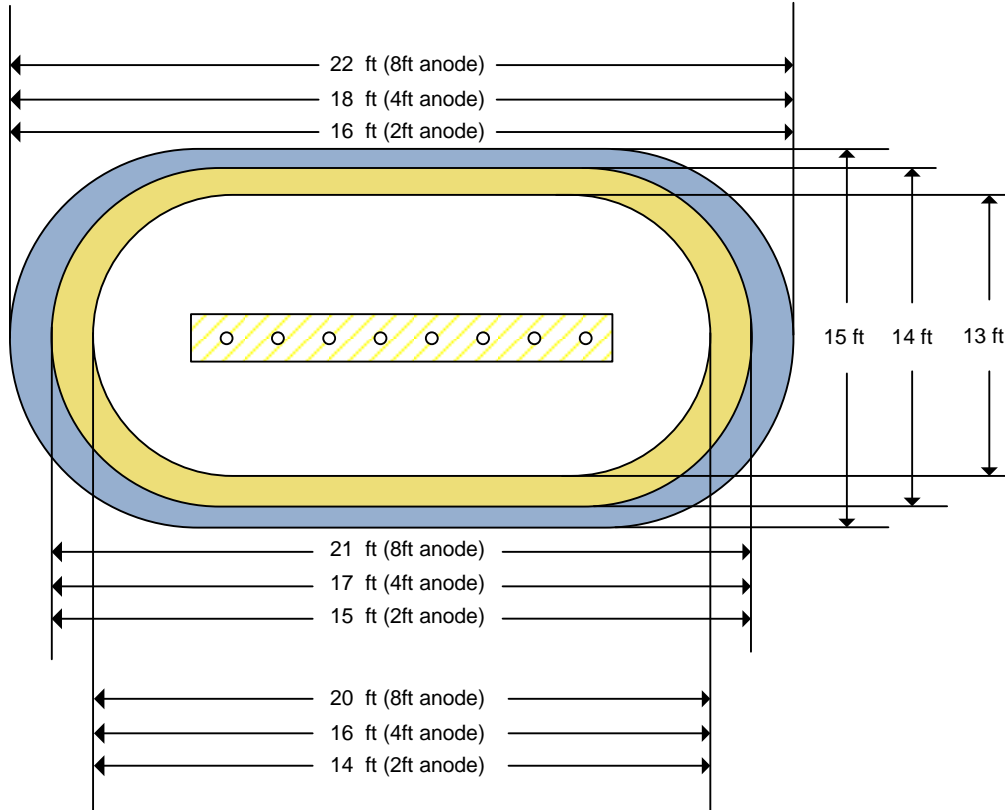

Figure D-1: Area to abrasive blast

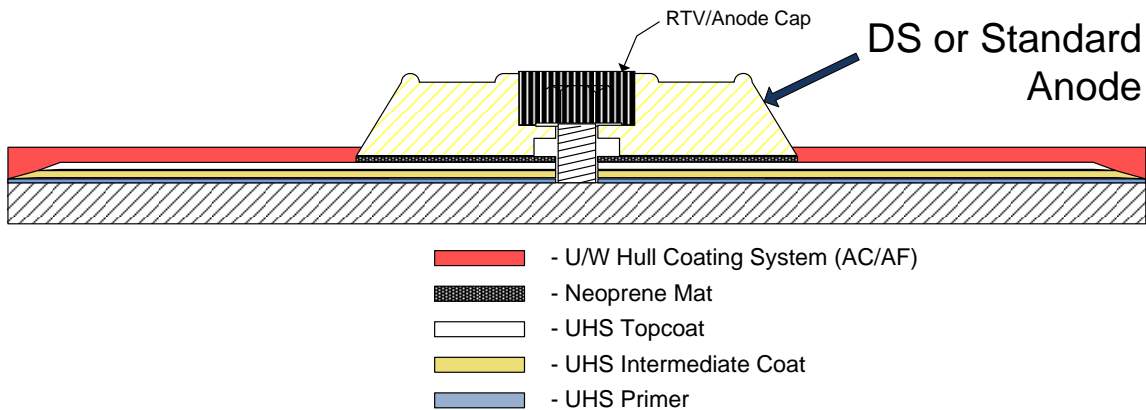

Figure D-2: Cross section of coating system and anode

## ATTACHMENT E

### ICCP Sprayable Dielectric Shields Application Instructions Without Removal of Existing Anodes

1. If anode is determined to be in good condition, install a fitted metal covering to prevent damage during surface preparation and coating application. Install plug or masking material for the protection of areas not to be painted to include sea chests and other areas as directed by the SUPERVISOR.
2. Low pressure water wash the existing Capastic shield.
3. Abrasive blast the shield area to SSPC-SP 5, leaving a 10 inch diameter ring of Capastic around the anode. Feather the transition between bare steel and the anode, gradually tapering the Capastic from the height of the anode to the bare steel in one smooth transition. QA checkpoints are conducted in accordance with 3.7.
4. Inspect remaining Capastic to ensure it is tightly adherent, intact, and has no visible cracking. If the Capastic is in good condition, move to step 6.
5. If any unsound Capastic is found within the 10 inch ring, blast the area to SSPC-SP 5 and apply Capastic. If for any reason the Capastic is not able to be repaired, or damage to the anode is found, the anode must be removed and the shield preserved in accordance with Standard Item 009-32.
6. Hand sand the remaining Capastic with 80 grit sandpaper and solvent wipe to SSPC-SP 1 cleanliness.

NOTE: All coatings must be listed in the Table and Line for “Dielectric Shields” and be applied in accordance with their NAVSEA-reviewed ASTM F718. All QA checkpoints must be conducted in accordance with 3.7.

7. Apply primer to the DFT required by the manufacturer’s NAVSEA-reviewed ASTM F718.
  - a. For 8 foot anode, prepare area 15 feet by 22 feet in accordance with Figure E-1.
  - b. For 4 foot anode, prepare area 15 feet by 18 feet in accordance with Figure E-1.
  - c. For 2 foot anode, prepare area 15 feet by 16 feet in accordance with Figure E-1.

NOTE: Intermediate and topcoat cannot be applied at required thickness in single pass without significant runs and sags. To prevent application defects, apply coatings in two passes as instructed below.

8. Within the primer’s specified overcoat window, apply the first pass of the intermediate coat at a thickness between 13 and 18 mils. The intermediate coat must be applied to the anode area within 5 to 7 inches of the primer boundary, leaving a 5 to 7 inch band of primer along the perimeter.

- a. For 8 foot anode, coat area 14 feet by 21 feet in accordance with Figure E-1.
  - b. For 4 foot anode, coat area 14 feet by 17 feet in accordance with Figure E-1.
  - c. For 2 foot anode, coat area 14 feet by 15 feet in accordance with Figure E-1.
9. Within 5 minutes of completion of the first pass, begin applying the second pass of intermediate coat to acquire the required minimum DFT of 30 mils.
10. Within the intermediate coat's specified overcoat window, apply the first pass of topcoat coat at a thickness between 13 and 18 mils in a contrasting color. The topcoat must be applied to the anode area within 5 to 7 inches of the intermediate coat boundary, leaving a 5 to 7 inch band of intermediate coat along the 5 to 7 inch band of primer.
- a. For 8 foot anode, coat area 13 feet by 20 feet in accordance with Figure E-1.
  - b. For 4 foot anode, coat area 13 feet by 16 feet in accordance with Figure E-1.
  - c. For 2 foot anode, coat area 13 feet by 14 feet in accordance with Figure E-1.
11. Within 5 minutes of completion of the first pass, begin applying the second pass of topcoat to acquire the required minimum DFT of 30 mils.
12. Allow topcoat to cure for minimum recoat time and ensure the total coating system meets the required 70 mils minimum DFT.
13. Within the topcoat's specified overcoat window, apply the underwater hull coating system over the entire dielectric shield area.
14. Remove masking from step 1.

Note: If any overcoat windows are breached, standard recovery methods apply – hand sand with 80 grit sandpaper to degloss, then solvent wipe to SSPC-SP 1 cleanliness and continue painting.

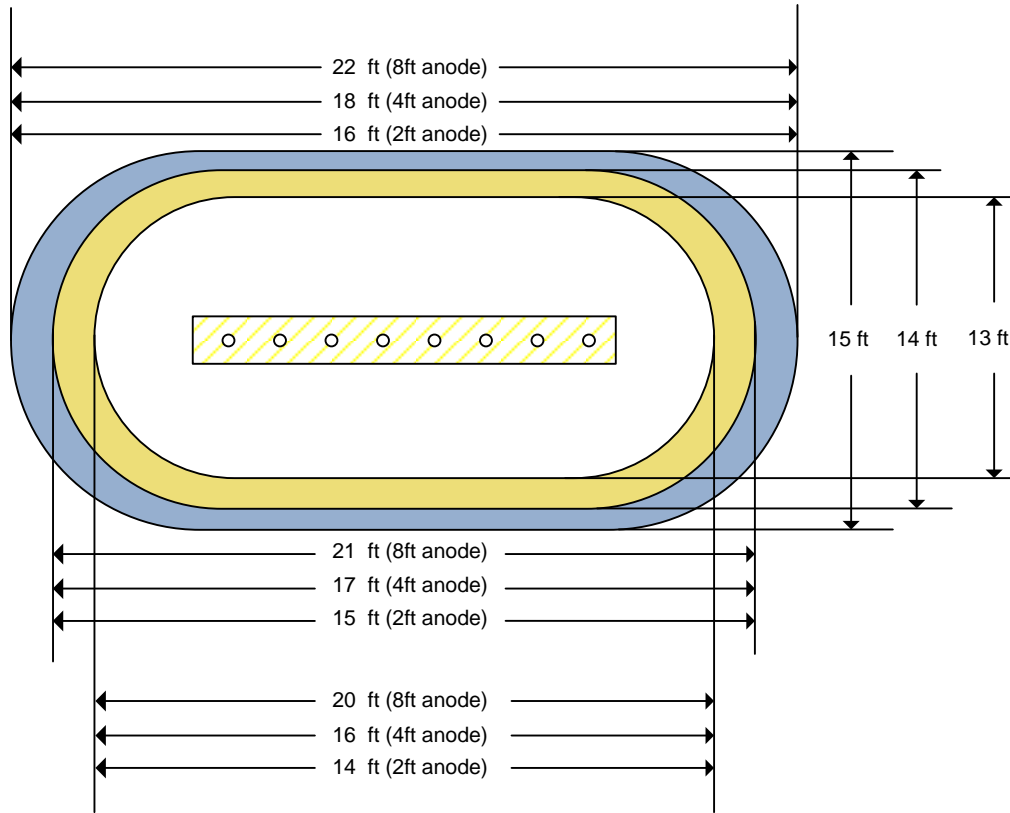

Figure E-1: Area to abrasive blast

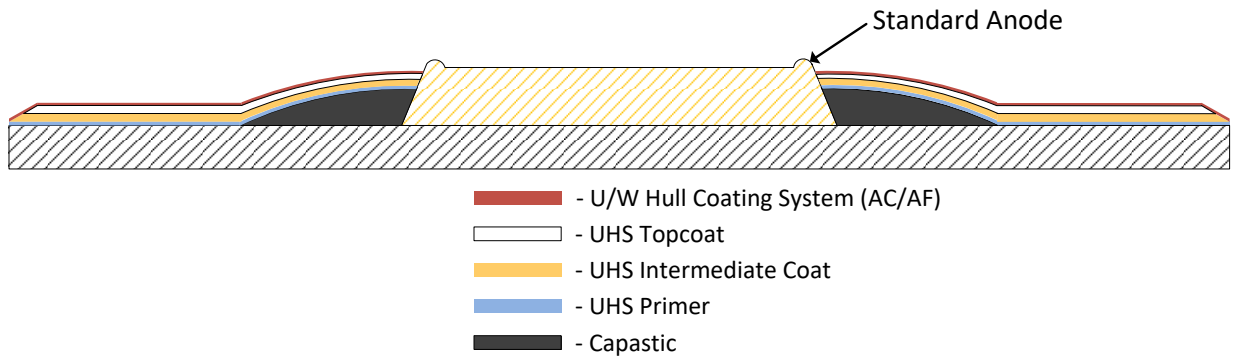

Figure E-2: Cross section of coating system and anode

## ATTACHMENT F

### Process for SSPC-SP 18 Thorough Spot and Sweep Blast Cleaning of Areas Previously Coated with MIL-PRF-23236, Type VII Coatings

The SSPC-SP 18 surface preparation must only be conducted in accordance with the specified lines in Tables 2 and 4. The SSPC-SP 18 surface preparation process must only be conducted in areas previously coated with MIL-PRF-23236, Type VII coatings. Validate that areas were previously coated with MIL-PRF-23236, Type VII coatings by QA records review or by validating dry film thicknesses in the area are between 14 and 30 mils.

Preparing an area in accordance with SSPC-SP 18 does not waive any surface preparation QA steps or data recording requirements except as modified below.

1. Blaster qualification. All blasters conducting SSPC-SP 18 surface preparation must be certified in accordance with SSPC C-7, SSPC CAS Level 2, or NAVSEA-approved equivalent.
2. Pre-job validate. Prior to starting abrasive blasting of an area to an SSPC-SP 18 level of cleanliness, the blaster must prepare a sample area that is 9 square feet or larger, and that includes corroded steel and MIL-PRF-23236, Type VII coating that is to be retained, to demonstrate compliance with SSPC-SP 18 requirements. Validate the SSPC-SP 18 requirements for retained coating in the area. Validation will include profile measurement on an area of exposed steel prepared to an SSPC-SP 10 level of cleanliness. Documentation of this validation shall be on QA Checklist Form Appendix 3 or Naval Shipyard QA Checklist Form Appendix 3 or 3A. The QA Checklist Form Appendix 3 or Naval Shipyard QA Checklist Form Appendix 3 or 3A must note the area will be prepared in accordance with SSPC-SP 18 and retained with the preservation records for the total preservation identified in the Work Specification.
3. Surface profile. For surfaces listed in 3.7, accomplish the requirements for profile measurements of 3.10.5 following SSPC-SP 18 preparation.

3.1 The required number of surface profile measurements must be calculated based on the cumulative area of substrate prepared to a near white metal, SSPC-SP 10 level of cleanliness. If the cumulative area prepared to SSPC-SP 10 is less than 100 square feet, a minimum of three profile measurement must be recorded. For areas listed in 3.7, document surface profile on QA Checklist Form Appendix 3 or Naval Shipyard QA Checklist Form Appendix 3 or 3A.

3.2 Profile measurements must not be accomplished on retained MIL-PRF-23236, Type VII coatings. The QA Checklist Form Appendix 3 or Naval Shipyard QA Checklist Form Appendix 3 or 3A must note the retained MIL-PRF-23236, Type VII coating was visually inspected in accordance with SSPC-SP 18.



4. Conductivity. For surfaces listed in 3.7, accomplish the requirements for conductivity measurements of 3.10.6. If the cumulative area prepared to SSPC-SP 10 is less than 100 square feet, a minimum of one conductivity measurement must still be recorded. For areas listed in 3.7, document conductivity on QA Checklist Form Appendix 4. Conductivity measurements must not be accomplished on retained MIL-PRF-23236, Type VII coatings.

5. SSPC-SP 1 inspection/validation. Upon completion of surface preparation in accordance with SSPC-SP 18, visually inspect retained MIL-PRF-23236, Type VII coating for staining, discoloration, or other evidence of hydrocarbon absorption. A visual water break test (ASTM F-21 or F-22) may be used to validate SSPC-SP 1 cleanliness in areas with retained MIL-PRF-23236, Type VII coating that may be stained or discolored. Any area that fails to pass a SSPC-SP 1 visual assessment and/or a water break test must be removed by abrasive blasting to an SSPC-SP 10 level of cleanliness.

6. Single coat application. Upon completion of surface preparation in accordance with SSPC-SP 18, apply one coat of MIL-PRF-23236, Type VII coating in accordance with the specified lines in Tables 2 and 4.

6.1 The applied coating must be in a contrasting color to the MIL-PRF-23236, Type VII coating that is retained after the SSPC-SP 18 surface preparation.

6.2 During paint application, a WFT gauge must be used to verify the application of proper film thickness (see 3.10.10.3 and SSPC-SP 18, section A8.5). WFTs must be taken on flat surfaces to ensure accuracy, and must be taken in areas where the paint was applied over retained MIL-PRF-23236, Type VII coating. WFT readings are not required to be recorded.

7. Coating inspection. Inspect newly applied MIL-PRF-23236, Type VII system as directed in 3.10.9 and accomplish DFTs per 3.10.9.1 and 3.10.10. For areas listed in 3.7, document on QA Checklist Form Appendix 7.

7.1 DFT readings must not be taken in areas where a stripe coat was applied.

7.2 The maximum allowable DFT for application of a MIL-PRF-23236, Type VII coating over an SSPC-SP 18 prepared surface is 60 mils.

## NOTES OF TABLES ONE THROUGH 5 FOR SURFACE SHIPS

- (1) Draft marks are applied directly over the complete antifouling system.
- (2) Boottop - The boottopping is defined as the black area from minimum load waterline at which the ship is expected to operate to 12 inches above the maximum load waterline. The black paint is an antifouling paint conforming to MIL-PRF-24647. The haze gray MIL-PRF-24635 must not overlap onto the black MIL-PRF-24647 antifouling topcoat.
- (3) This area includes DDG-51 Class top of stacks (i.e., 05 level weather decks and bulwarks).
- (4) For the structural decks within the machinery spaces above the bilge line, use the Table Lines for "INTERIOR DECK PASSAGEWAYS NOT RECEIVING DECK COVERINGS."
- (5) Applicable to mast and yardarm surfaces as approved by the SUPERVISOR.
- (6) A minimum of 24 hours drying time must be allowed after last coat prior to undocking.
- (7) Within a zone or work area, a proprietary nonskid system listed on the QPL for MIL-PRF-24667 must be used.
- (8) For applications below 50 degrees Fahrenheit, MIL-PRF-24647 coatings must be used in accordance with the NAVSEA-reviewed ASTM F-718 to determine lower application temperature limit. Do not apply these coatings below 35 degrees Fahrenheit.
- (9) MIL-PRF-24596, Grade C, Classes 1 and 2 or MIL-DTL-24607 must be used if surface and ambient temperatures are less than 50 degrees Fahrenheit.
- (10) The "inner shield" is defined as the portion of the dielectric shield that extends 3 ft. from the anode in all directions. The "outer shield" is defined as the portion of the dielectric shield from the inner shield to a distance of 6 ft. from the anode. Repair of the inner shield area is required when total deteriorated inner shield surface area is from 0 to 2 percent, and no single spot is greater than one square foot. Repair of the outer shield area is required when total deteriorated outer shield surface area is from 0 to 10 percent, and no single spot is greater than one square foot. Replacement (new installation) of the entire dielectric shield is required when either of the above criteria is exceeded (damage to the inner shield is greater than 2 percent, OR damage to the outer shield is greater than 10 percent, OR any single spot damage is greater than one square foot). Repair of this system must be performed with EVOQUA Water Technologies LLC part number Capastic™ 35524 (W3T106410).
- (11) Attachments D must be used for sprayable dielectric shield application for removed and new anode installations. Attachment E must be used for sprayable dielectric shield application without removal of existing anodes.
  - a. During visual inspection, ensure anode surfaces are undamaged and free of paint and dielectric shield material.
  - b. The anode should remain covered with heavy cardboard or plywood to prevent damage or contamination by the ship's underwater hull coating system until just before undocking.

- (12) These systems may also be invoked for preservation of decks in spaces that are prone to wear and do not receive deck covering.
- (13) Anchors below lower boottopping limit must be painted in accordance with normal underwater hull anti-corrosion/antifouling system.
- (14) For MCM class ships, use walnut shells, garnet, or crushed glass for abrasive blast media. Waterjetting to NACE/SSPC-SP WJ-2/L may be used in place of NACE 2/SSPC-SP 10. Waterjetting to NACE/SSPC-SP WJ-3/L may be used in place of NACE 3/SSPC-SP 6.
- (15) Anchor chain and detachable links must be marked and color-coded in accordance with NSTM Chapter 581 unless otherwise directed by the Work Item or task order. Stern gate chain must be haze gray.
- (16) Apply polysulfide compound conforming to MIL-PRF-81733, Type II, Class 2, after primer application, prior to topcoat application.
- (17) Colors shown in Tables 631-8-10 and 631-8-11 of 2.2 must be specified by TYCOM, ship's Commanding Officer, or the SUPERVISOR for boats and small craft in accordance with Paragraph 631-8.18.3.2 of 2.2.
- (18) Restore each compartment marking in accordance with 2.11 and 2.12.
- (19) MIL-PRF-24667 nonskid systems must be applied as a complete system from the same manufacturer. The use of any manufacturer's MIL-PRF-24667 color topping is authorized over any MIL-PRF-24667 nonskid including type XI nonskid.
- (20) Prior to accomplishing painting of wooden underwater hulls, allow the hull to dry to a moisture content of 15 percent. Readings must be taken with an electronic moisture meter, Sovereign Moisture Master or equal. Cover grounding plates and zincs prior to painting.
- (21) Blasted surface metal must be degreased following walnut shell blasting. Even traces of residual oil will degrade paint adhesion. Appropriate safety precautions for working with flammable solvents must be enforced. Alternate procedure is a vigorous soap and water wash followed by pressurized fresh water rinse. Do not use a detergent and fresh water washdown when using aluminum oxide as an abrasive blast medium.
- (22) Peripheral deck edging and areas not receiving nonskid may use either the manufacturer's MIL-PRF-24667 color topping or MIL-PRF-24635 Type V. Aircraft tie-downs may be coated with MIL-DTL-24441 F-155 in lieu of nonskid color topping.
- (23) For DDG Flight II class ships where troughs are installed, topcoat using Deck Gray for trough covers and troughs.
- (24) For application of the "single coat" products (by brush, roller, or spray), the product must be applied all at one time, meaning during a continuous spray and touch-up operation. Specifically, a "single-coat" system involves one color of paint, applied during one work evolution (i.e., no time is required to wait for the paint to dry), with a single pass or double pass. Because the spray application is one work evolution, coating inspection QA checkpoint 3.10.9 need only be conducted after completion of application of the full coat. Completing a single work evolution may involve actions over numerous days, but it is still one evolution, requiring one QA checkpoint. If a tank or void is touched-up with a contrasting color, it is acceptable for the area to have a multi-color appearance.

- (25) Power impact tool cleaning using power-driven needle guns, chipping or scaling hammers, rotary scalers, single or multiple-piston scalers, or other similar impact cleaning tools must not be utilized in the cleaning methods.
- (26) For newly installed coating repair or replacement, maintain the relative humidity in the tank or void space at a maximum of 50 percent from surface preparation checkpoint acceptance until cure to recoat time of final touch-up of the topcoat; relative humidity must be maintained at a maximum of 85 percent from cure to recoat for the final touch-up of the topcoat through cure to service. For in-service coating touch-up until cure to immersion of topcoat, maintain relative humidity at a maximum of 85 percent.
- (27) Finish coats for boats and craft must be as specified in Paragraph 631-9.3.2 through 631-9.3.3 of 2.2 unless otherwise specified in the invoking Work Item or task order.
- (28) Thermal insulation must be soap and water cleaned and hand sanded.
- (29) Three coats of MIL-DTL-24441, Type III at 3-4 mils per coat can be substituted for 2 coats of MIL-DTL-24441, Type IV at 4-6 mils per coat, for total system DFT of 8-12 mils. Three full coats and 2 stripe coats of MIL-DTL-24441, Type III at 3-4 mils per coat can be substituted for 2 full coats and one stripe coat of MIL-DTL-24441, Type IV at 4-6 mils per coat, for total system DFT of 8-12 mils.
- (30) Grit blasting to near white metal is the preferred method of surface preparation. Only where grit blasting is not possible should power tool cleaning be used with prior authorization by the SUPERVISOR. Power tool cleaning should not be used for well deck areas frequently exposed to LCAC exhaust.
- (31) A low-pressure (3,000 to 5,000 PSI) fresh water washdown of the well deck area must be performed before either grit blasting or power tool cleaning to remove dirt, oil, grease, salts, and loosely adherent paint.
- (32) Upon completion of the 3.10.7 surface preparation, pH measurements will be documented on QA Checklist Form Appendix 3 in the comments section or Naval Shipyard General Comment Sheet. The pH must be in the range of 6.5 to 7.5. If the pH is not within this range, wash the surface with potable water until the required pH is obtained.
- (33) If approved by the SUPERVISOR, the surface preparation method of Spot and Sweep, described in Attachment C may be used in place of the surface preparation SSPC/NACE standard required in the Table Line.
- (34) These systems may also be invoked for preservation of well deck bulkheads and decks.
- (35) The topcoat in jet blast deflector (JBD) pits and barricade stanchions must be painted with one coat MIL-DTL-24441, white, 4-6 mils or MIL-PRF-23236 Type VI, white, at 4-8 mils.
- (36) SSPC-SP 11 must be the surface preparation standard used, even if the applicable NAVSEA-reviewed ASTM F718 has a more stringent requirement.
- (37) Total DFT specified for potable water tanks must not be exceeded except in isolated areas adjacent to shapes and stiffeners. In no case must the maximum DFT be exceeded by 2 mils. The isolated areas must be less than 2 percent of the total area.

- (38) Maintain the relative humidity in the tank at a maximum of 85 percent from the start of abrasive blasting to cure of the topcoat. By allowing 85 percent vice 50 percent relative humidity, this will reduce the service life of the tank from 15-20 years to 10-12 years.
- (39) PPG Industries PSX 892HS must not be used for surfaces that exceed 700 degrees Fahrenheit.
- (40) Do not stripe coat inside surfaces of the Sonar Trunk Guide Rail angles.
- (41) Apply 3 coats of a vapor barrier-coating compound, MIL-PRF-19565, in contrasting colors (final coat white), to thermal insulation within laundries, sculleries, galleys, drying rooms, and to thermal insulation on the warm side of refrigerated stores spaces.
- (42) High temperature areas of exhaust pipe exteriors include air eductors and exhaust stacks.
- (43) In lieu of white, use Light Gray, Color No. 26373 (Low Solar Absorption only). In lieu of black, use Ocean Gray, Color No. 26173 (Low Solar Absorption only).
- (44) These systems must also be invoked for Aircraft Electrical Servicing Stations (AESS) trunks.
- (45) Passive Counter-measure System (PCMS) tile on the bow flares must be painted with the same topcoat as the freeboard.
- (46) As directed by the SUPERVISOR, remove nonskid within 18 inches of any visible Thermal Spray Nonskid (TSN) using High Pressure Waterjet Cleaning (HP WJ) with an initial operating pressure of 10,000 PSI. Increase HP WJ operating pressure by increments of up to 2,000 PSI until the HP WJ process removes nonskid without damage to the underlying TSN. Conduct six passes over the work zone at the operating pressure that removes nonskid, but does not damage the underlying TSN, to remove the nonskid. HP WJ operating pressure must not exceed 25,000 PSI.
- (47) The topcoats for ordnance/non-ordnance pyrotechnic locker sun shields must be painted white or as directed by NAVSEA.
- (48) All of the AC and AF coats in the product system must be from the same manufacturer.
- (49) As directed by the SUPERVISOR, verify that Thermal Spray Nonskid (TSN) substrate has dried following any water cleaning, water jet preparation, or other exposure to water before MIL-PRF-24667 nonskid primer is applied to the TSN tie in zone.
- (50) "Cosmetic" color topping is not to be applied on top of nonskid on vertical replenishment or aviation decks.
- (51) Inorganic zinc silicate coatings must be applied in accordance with the manufacturer's instruction.
- (52) Do not blast fin stabilizers to near white metal. As-received fin stabilizers must be brush-off blasted to NACE 4/SSPC-SP 7 (Brush-Off Blast Cleaning) in lieu of near white metal blast to ensure polymer fairing compound is not removed prior to application of paint.

Blank, wrap, cover, or mask equipment, shafts and openings to preclude damage and prevent entry of contaminants prior to cleaning operation. Remove protective covering upon completion of preservation operations.

- (53) “Total System” value is only listed when it is more stringent than the sum of the individual coats of the system.
- (54) This Table Line does not apply to propulsion plant water tanks aboard nuclear-powered ships.
- (55) For MIL-PRF-23236 Type VII Class 9, 9/18, 11, and 11/18 paints, follow the NAVSEA-reviewed ASTM F718 for temperatures, cure and recoat times. This supersedes the 70 degree Fahrenheit, 36/12-hour/5 day requirement.
- (56) Nonskid must be applied to within 3.5 – 4.0 inches of the exterior and interior helicopter hangar door seal edges.
- (57) Painting PCMS tile on paint-allowed PCMS ships will be to match surrounding surfaces and as designated by the SUPERVISOR. Painting is prohibited on no-paint PCMS ships.
- (58) Products used for the primer or single coat must contain OAP. Touch-up coating is not required to contain OAP.
- (59) Composition L nonskid may be used in Composition G areas with TYCOM approval.
- (60) MIL-PRF-24667 Composition L material must be applied in areas designated by the VLA General Services Bulletin Number 8.
- (61) For flight decks equipped with RAST tracks, see Figure One for guidance on RAST track plates.

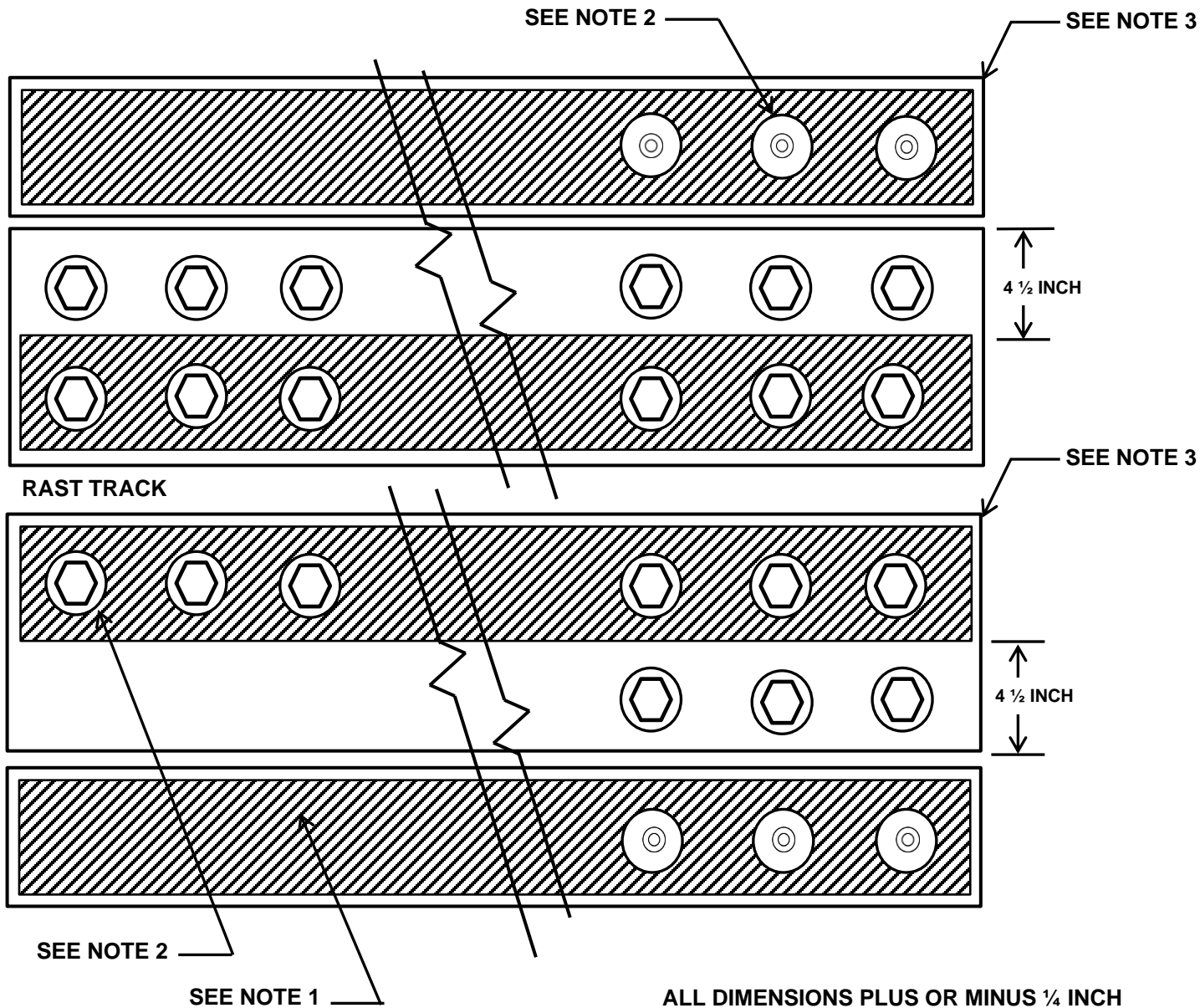

Figure One

NOTES:

1. APPLY NONSKID ONLY TO CROSS-HATCHED AREAS.
2. NO NONSKID ON 2-3/4 to 3-1/4 INCH DIAMETER CIRCLES CENTERED ON HOLES.
3. ¾ INCH MASKING AROUND ALL PLATE EDGES.

(62) Once the old nonskid system is removed, or if it is a new deck being prepared for nonskid system installation, the surface of the GRP fiberglass must be lightly hand-sanded with 80-grit paper to roughen the surface.

- (63) Nonskid must be applied to within 2-3 inches of deck fittings and protrusions. Nonskid must be applied to within 4-6 inches from coamings and deck edges. Areas underneath protrusions, such as stowage racks or fire stations that are normally found on hangar decks, or coaming areas of decks not subject to vehicle or aircraft movement, need not comply with the 4-6 inch rule for applying nonskid near deck edges.
- (64) Primer coat(s) must be from the same manufacturer as the other coats in the system.
- (65) Fuel oil storage, fuel oil service, fuel oil gravity head tanks, and diesel service tanks are not required to be painted unless specifically addressed in the tables. For existing paints, when flaking occurs, SSPC-SP 3 surface preparation must be accomplished and a light coat of system fluid must be wiped over the surface prior to closing. If preconstruction primer was applied in accordance with 3.1.5, it may be retained, but it must be overcoated with one coat MIL-PRF-23236, Type V, VI, or VII Class 5 at 4-8 mils.
- (66) Do not apply primer to bulkheads and overheads.
- (67) Prepare surfaces in accordance with Thorough Spot and Sweep Blast Cleaning as described in Attachment F.
- (68) For interior surfaces of stern tubes and extensions, strut barrels, fairwater interiors, shaft flanges (not exposed to seawater) and coupling covers, only apply 2 coats of anti-corrosive.
- (69) Intentionally left blank.
- (70) MIL-PRF-24635, Type III, Class 2, Grade B or C is permitted for touch-up repairs of existing MIL-PRF-24635, Type III, Class 2, Grade B or C.
- (71) Hand sand or use orbital sander with 80-120 grit sandpaper.
- (72) MIL-PRF-24667 Type I spray-applied products are not authorized for application to critical coated areas on CVNs.
- (73) Runs, drips, and sags may appear in application of MIL-PRF-23236, Type VII paint. When wet, runs, drips, and sags must be brushed out to form a smooth, uniform film. When cured, runs, drips, and sags must be evaluated by the SUPERVISOR and if found to be detrimental to the coating system, must be repaired.
- (74) Painting over PCMS tile is not allowed, except tiles that are installed to the hull.
- (75) The entire deck surface (i.e. forecastle, fantail, flight, etc.) containing a Vertical Replenishment Deck area must be considered a critical coated area as addressed in 3.7.
- (76) For aircraft carriers, substitute 1 stripe coat of primer for the 2<sup>nd</sup> primer full coat.
- (77) Bilge drain wells are to be coated with the coating systems for machinery spaces, bilges & distilling unit pans. The MIL-PRF-32584, Type III coating system for AFFF decks (i.e., under AFFF Proportioning Units) may be applied to bilge drain wells and must be applied to bilge drain wells on DDG and CG Class ships.
- (78) SSPC-SP 3 of tightly adherent paint may be used for locations located 12 inches and above the inner bottom tank top for the bilge area, with the exception that the exterior structure of stand-alone tanks on aircraft carriers will require a minimum of SSPC-SP 11.



- (79) Intentionally left blank.
- (80) Maximum water pressure must be such that 30 seconds of stationary operation of the vacuum self-contained equipment produces no visible degradation of the nonskid surface. Vacuum self-contained equipment must be capable of cleaning within 4 inches of bulkheads, coamings, and other deck appurtenances.
- (81) Abrade sides of dielectric shield anode bars by hand with 80 grit sandpaper to SSPC-SP 2 and verify SSPC-SP 1 cleanliness prior to first application of dielectric shield to the bar.
- (82) Each cell hatch lip must be prepared to SSPC-SP 2.
- (83) Nonskid on vehicle ramps must be rolled perpendicular to the main axis of the ramp. Welds must not be cross-rolled on vehicle ramps.
- (84) For applications when substrate temperature cannot be maintained above 50 degrees Fahrenheit, MIL-PRF-23236 coatings must be used in accordance with the NAVSEA-reviewed ASTM F718 to determine the lower application temperature limit. Do not apply these coatings below 35 degrees Fahrenheit substrate or ambient temperature.
- (85) As designated by the SUPERVISOR, apply topside coating colors and patterns in accordance with 2.7.
- (86) For aircraft carriers only, MIL-PRF-24635, Type III, Class 2, Grade B or C may be substituted where MIL-PRF-24635, Type V and VI, Class 2, Grade B or C is specified.
- (87) Coat the prepared surface one foot beyond the prepared surfaces, cut back areas of 1 1/2 inches from cutouts, exposed edges, high wear areas, and label plates and 2 inches from the deck with MIL-PRF-24635, Type V of VI, Class 2, Grade B or C.
- (88) If no products are listed on QPL-32584, utilize the legacy QPLs as listed below,  
a. MIL-PRF-32584, Type I: MIL-PRF-32171, Type I  
b. MIL-PRF-32584, Type II: MIL-PRF-32171, Type III  
c. MIL-PRF-32584, Type III: MIL-PRF-32171, Type IV
- (89) When hand tool or power tool aluminum cleaning to SSPC-SP 2 Hand Tool Cleaning, SSPC-SP 3 Power Tool Cleaning, SSPC-SP 11 Bare Metal Power Tool Cleaning, and SSPC-SP 15 Commercial Power Tool Cleaning only stainless steel needles, stainless steel bristle impact belts, stainless steel wire brushes, stainless steel scouring pads, or aluminum oxide abrasive sanding pads must be used. None of these materials must have been previously used on other metal, or for the removal of copper pigmented paint, prior to being used on aluminum. Rotary sanders or grinders fitted with abrasive discs or flap wheels, and rotary impact tools fitted with cutter or hammer bundle assemblies are not authorized on aluminum substrates. Rotary impact tools may only be fitted with tungsten carbide tipped, rubber impregnated woven nylon cloth flaps.
- (90) When waterjetting an aluminum surface to SSPC-SP WJ-2/NACE WJ-2, the surface cleanliness requirements must be the same as that stated in the standard, except that the words "corrosion products" must be substituted for the word "rust"; and the flash rusting requirement does not apply.

- (91) For nonskid removal using waterjetting on LCS 2 Class ships, the pressure must not exceed 30,000 PSI.
- (92) After nonskid installation, remove masking from bolted-crossbar aircraft securing fittings. Unless directed by the SUPERVISOR, do not conduct surface preparation or apply coatings to bolted-crossbar aircraft securing fittings.
- (93) Except in machinery spaces of nuclear-powered ships and medical spaces, TT-P-645 may be replaced by MIL-DTL-24607 applied at 2-4 mils per coat.
- (94) For wet spaces or weather exposed spaces, topcoat to match surrounding area.
- (95) Runs, drips, and sags may appear during application of FS1 paint. When wet, runs, drips, and sags must be brushed out to form a smooth, uniform film. Runs, drips, or sags that have dried to touch in accordance with the NAVSEA-reviewed ASTM F718 must not be sanded to reduce DFT without approval of the SUPERVISOR.

## NOTES OF TABLES 6 THROUGH 8 FOR SUBMARINES

- (1A) Hull inserts must be coated with the preservation system applied to adjacent surfaces. Extend paint system on to non-ferrous liner or cladding for a minimum of 1/2 inch or as directed by the SUPERVISOR. For MBT vent valves, preserve weld radius of the clad sealing surface and the vertical surface mating with the MBT vent valve gasket retainer; the only surface which is not painted is the horizontal clad sealing surface which mates with the MBT vent valve disc gasket.
- (2A) Alternating AF colors may be used. Final coat can be red or black.
- (3A) The upper boottop limit is extended to 12 inches above the maximum condition diving trim waterline. For all surfaces above max beam that are to receive AF, all coats must be black. The final coat of all exterior paint systems above the upper boottop must also be black.
- (4A) A minimum of 24 hours drying time must be allowed after last coat prior to undocking.
- (5A) Products used for the primer or single coat must contain OAP. Touch-up coating is not required to contain OAP.
- (6A) Blasting is not allowed in machinery spaces.
- (7A) Topcoat color must match surrounding paint on visible surfaces.
- (8A) MIL-PRF-23236 Type VII Class 17 NAVSEA-reviewed paints for interior submarine use under the Submarine Atmosphere Control Manual are International Interbond 998 and Sherwin-Williams Euronavy ES301.
- (9A) To minimize premature yellowing, chlorinated alkyd-based paints (MIL-DTL-24607) must not be applied within 4 weeks before and after the application of amine-cured epoxy paints formulated to MIL-PRF-23236.
- (10A) When using MIL-DTL-24607 paints, use Table 631-8-10 of 2.2 to select approved colors.
- (11A) MIL-PRF-24596 Class 2, Grade A, and Formula 25A may be substituted for MIL-DTL-24607 chlorinated alkyd enamels. Color must match the existing surroundings.
- (12A) The SSBN/SSGN-726 Class logistics escape trunk (LET) fasteners and bubble skirt knife edge in way of gaskets and fasteners for LET upper hatch fairings are to be left unpainted.
- (13A) The Environmental Protection Agency (EPA) has found that samples of vermiculite ore contain asbestos fibers. Vermiculite was used as an anti-sweat treatment on the upper hatch covers on submarines. All facilities and workers must assume vermiculite contains asbestos fibers until it has been tested. All facilities are to test new vermiculite or vermiculite in use prior to working with the material. Workers who are doing work with or near vermiculite should be aware that it may contain asbestos and proper precautions must be used.
- (14A) The requirements of SSPC-SP 1 must be met via a HP or UHP fresh water washdown of the tank prior to blasting the tank to NACE 2/SSPC-SP 10.

- (15A) Motor generators require protection from paints conforming to MIL-DTL-24441 or MIL-PRF-23236 during application and curing of the paint. When these paints are being applied or cured while venting in a space containing motor generators, the motor generators must be protected using a NAVSEA-approved procedure. For 300 kilo-watt (kW) and 500 kW motor generators, a positive pressure unit according to Appendix A of the motor generator technical manual must be used. Maintenance on motor generators must not be performed for a minimum of 5 days after painting with MIL-DTL-24441 and MIL-PRF-23236 paints or any application of silicones (e.g., TT-P-28, MIL-PRF-24635 silicone enamels) in the engine room.
- (16A) When lead is removed from lead bins, the structure must be blasted to NACE 2/SSPC-SP 10 and preserved with an ultra-high solids paint, (even if the surrounding structure is being touch-up painted) prior to installing lead.
- (17A) Non-ferrous and corrosion-resistant steel piping and CRES torpedo system components in torpedo impulse tanks must not be painted; non-ferrous and CRES piping above residual waterline in MBTs is not required to be painted.
- (18A) Succeeding coats of the coating system must be of contrasting color, and the top coat must be white or a very light pastel shade.
- (19A) CRES fasteners (studs, nuts, washers) used to secure Type II vibration damping and acoustic tiles may be left unpainted.
- (20A) Unpainted upper portions of Normal Fuel Oil (NFO) and all areas of hydraulic oil, hydrophone, and Clean Fuel Oil (CFO) tanks must not be painted unless required in Table 8. Surface preparation and URO MRC 003 inspections are to be performed as required and bare steel must be coated with applicable system fluid or preservative as approved by the SUPERVISOR. Lube oil sludge tanks on SSBN/SSGN-726 Class submarines must not be painted.
- (21A) Reduced touch-up paint curing procedures of Section 7 of 2.2 do not apply to these surfaces. Also, note accelerated touch-up times authorized by 2.2 are for non-reactor potable water tanks only, and therefore are not to be used for potable water, reserve feedwater, and freshwater drain collecting tanks unless specifically approved by NAVSEA.
- (22A) Total DFT specified in Table 8 for potable water tanks must not be exceeded except in isolated areas adjacent to shapes and stiffeners. In no case must the maximum DFT be exceeded by more than 2 mils. The isolated areas must be less than 2 percent of the total area. For touch-up or overcoating intact aged paint in good condition, the same requirements for each coat apply, and the total film thickness maximum requirement may be corrected to allow for thickness of underlying aged paint.
- (23A) Prior to surface preparation, flasks must be depressurized. Barrier protection must be in accordance with NAVSEA S0400-AD-URM-010/TUM, Tag-Out User's Manual (TUM), Appendix G.
- (24A) Welds and area above welds will be coated with MIL-DTL-24441 primer (at 4-6 mils/coat) and 2 coats MIL-PRF-24635 (Composition 2 at 5 - 8 mils/coat or Composition 1 at 2 - 3 mils/coat). Tek-Haz paint system must be applied in accordance with EB Specification 4277 and will extend to a line even with the underside of the ventilation plenum welds, but not including the welds.

- (25A) Bilge and Drain Collection Tanks includes the following: Bilge Collecting Tanks, Bilge Collecting Sump Tanks, Non-Oily Drain Collecting Tanks (other than Fresh Water), Oily Drain Collecting Tanks, Bilge Water Processing Tank, Drain Water Collecting Tanks, VLS Drain Collecting Tank, Oil Collection Tanks.
- (26A) For Moored Training Ships (MTS), the antifoulant coating is not required, because the tanks are blanked off and filled with fresh water.
- (27A) Conduct low voltage holiday detection on 100 percent of potable water tanks when MIL-DTL-24441 Type III paint is being applied. Holiday detection must also be performed on any repaired (touch-up) areas of an existing paint system. The holiday checks are to be performed after application of the topcoat using a low voltage wet sponge holiday detector. Any holidays (defects to bare metal) found must be marked by the inspector and the area touched-up. Holiday checks must be performed again on these areas after repair.
- (28A) All painting with organic solvent-based paints (alkyd, epoxy, oil based) that exceeds 1 quart per day for the entire ship must be completed 5 days prior to the date of departure as determined by the Commanding Officer. Date of departure, as it relates to painting, is the date of first dive after departure for a period of operation.
- (29A) For newly installed coating repair or replacement, maintain the relative humidity in the tank or void space at a maximum of 50 percent from surface preparation checkpoint acceptance until cure to recoat time of final touch-up of the topcoat; relative humidity must be maintained at a maximum of 85 percent from cure to recoat for the final touch-up of the topcoat through cure to service. For in-service coating touch-up until cure to immersion of topcoat, maintain relative humidity at a maximum of 85 percent.
- (30A) If no products are listed on QPL-32584, utilize the legacy QPLs as listed below,  
a. MIL-PRF-32584, Type I: MIL-PRF-32171, Type I  
b. MIL-PRF-32584, Type II: MIL-PRF-32171, Type III
- (31A) Tank manhole covers are critical coated areas. Solvent-based paint systems may be used to paint manhole covers of tanks painted with high solids paint systems due to fit-up issues associated with high solids paint systems. Powder coatings must not be applied to reserve feedwater, potable water, freshwater drain collecting, and steam surge tank manhole covers.
- (32A) Areas visible from above must be topcoated either gray or black.
- (33A) Total number of coats and total DFT specified in Table 7 for all interior spaces must not be exceeded. Maximum system total DFT must not exceed 17 mils for surfaces topcoated with MIL-DTL-24607, 21 mils for surfaces topcoated with MIL-PRF-24596, or 24 mils for surfaces topcoated with Formula 25A.
- (34A) Naval Shipyards are allowed to work on these items. All other activities are to be approved by NAVSEA.
- (35A) The David Taylor Research Center paint system (DTRC 2844-1110 and 2844-1109) may be used on other exterior hull areas. This is to allow areas adjacent to areas covered by MIP or SHT to be re-preserved the same as MIP or SHT areas. For areas requiring stripe coat, refer to 3.2.

- (36A) Areas within the HOSUB Deep Submergence System/Scope of Certification (DSS-SOC) boundary are not covered by this Standard Item but are covered by the applicable DSS-SOC preservation maintenance standard. The SUPERVISOR should be contacted to specify the areas that are outside the DSS-SOC boundary.
- (37A) Runs, drips, and sags may appear in application of MIL-PRF-23236, Type VII paint. When wet, runs, drips, and sags must be brushed out to form a smooth, uniform film. When cured, runs, drips, and sags must be evaluated by the SUPERVISOR and if found to be detrimental to the coating system, must be repaired.
- (38A) Final grooming of bow domes and chin arrays must be performed by qualified shipyard personnel. Final surface finish of bow domes must be 180 microinches Ra or smoother. Measure and record surface roughness in accordance with ASME B46.1-2009 Surface Texture (Surface Roughness, Waviness, and Lay.) If necessary, groom the surface of the dome to attain a maximum surface roughness of 180 microinches Ra. This additional grooming can be accomplished by wet sanding the surface by hand using 120 grit paper and fresh water. Refer to the appropriate bow dome manual for the class for more specific guidance on surface roughness, grooming and paint application.
- (39A) For MIL-PRF-23236, Type VII, Class 9 and 9/18 paints, follow the NAVSEA-reviewed ASTM F718 for temperatures, cure, and recoat times. This supersedes the 70 degree Fahrenheit, 36/12-hour/5-day requirement.
- (40A) For application of the "single coat" products (by brush, roller, or spray), the product must be applied all at one time, meaning during a continuous spray and touch-up operation. Specifically, a "single-coat" system involves one color of paint, applied during one work evolution (i.e., no time is required to wait for the paint to dry), with a single pass or double pass. Because the spray application is one work evolution, coating inspection QA checkpoint 3.10.9 need only be conducted after completion of application of the full coat. Completing a single work evolution may involve actions over numerous days, but it is still one evolution, requiring one QA checkpoint. If a tank or void is touched-up with a contrasting color, it is acceptable for the area to have a multi-color appearance.
- (41A) Powder coatings approved for use on submarines must comply with 2.4 and 2.6.
- (42A) Low Pressure Water Clean (LP WC) with a fan spray starting at a pressure of 1,000 PSI. Keep the cleaning lance nozzle tip perpendicular to and at least 4 inches from the surface. Increase pressure, if needed, in increments of 500 PSI up to a maximum of 5,000 PSI. Remove all paints down to sound gray or green anti-corrosive paint (F-151 or F-150) or bare GRP. Remove any remaining barnacle particles or other foreign objects with wood or plastic scrapers, or by sanding. Do not use wire brushes or other abrasive instruments.
- (43A) Remove all marine growth and existing paint from the boot surface by LP WC or sanding with soft back dual action or soft back random orbital sanders and 60 grit paper. Observe extreme caution when LP WC. Measure stand-off distance and control nozzle pressure to assure that the boot is not damaged during the cleaning process. LP WC must be performed using fresh water with a starting pressure of 1,000 PSI. Pressure must be increased in 500 PSI increments until the desired results are obtained. Scuff the entire boot surface using 60 grit paper or equivalent coarseness Scotch-Brite pad to remove any remaining paint and provide an adequately prepared surface for paint application. Clean the bare boot surface with degreasing solvent per MIL-PRF-680, Type I.
- (44A) Do not apply nonskid to Fairwater Planes or Retractable Bow Planes.

- (45A) MIL-PRF-24647 and MIL-DTL-24441, Type IV coatings may be used for cold weather applications below 50 degrees Fahrenheit. For cold weather applications of MIL-PRF-24647 and MIL-DTL-24441, Type IV coatings, the NAVSEA-reviewed ASTM F718 must be used to determine lower application temperature limit. Do not apply these coatings below 35 degrees Fahrenheit.
- (46A) Navy Formula F-187 cannot be applied over F-184.
- (47A) If performing touch-up of paint in Steam Plant Surge Tanks, one coat Dampney Company ENDCOR 450 (no DFT required) must be applied prior to application of the coats of Apexior No. 1.
- (48A) Foundation bearing surfaces for the bedplate or outboard transducer array assembly (OTAA) and surfaces of all through bolt mounting holes must be coated with one coat MIL-DTL-24441, Type IV, F-150 at 5 - 7 mils. These surfaces are not to be coated with single coat high solids and DFTs on these surfaces must not exceed 8 mils.

TABLE ONE STEEL SURFACES  SURFACE SHIPS	LINE	A SURFACE PREPARATION	B PRIMER	C	D	E KEEL TO BOTTOM OF BOOTTOP	F BOOTTOP	G DRAFT MARKS
<p>UNDERWATER HULL (KEEL TO TOP OF BOOTTOP, INCLUDING PROPULSION SHAFT OUTBOARD BEARING VOIDS AND SEA CHESTS)</p> <p>UP TO 3 YEARS SERVICE LIFE</p> <p>FOR SMALL BOATS AND SERVICE CRAFT ONLY (INCLUDING EMBARKED BOATS AND CRAFT)</p>	1	<p>NEAR WHITE METAL BLAST, NACE 2/SSPC-SP 10 - OR - WATERJETTING TO NACE/SSPC-SP WJ-2/M - OR - SSPC-SP 10/M (WAB)/NACE WAB-2/M</p> <p>SEE NOTE (33)</p>	<p>ONE AC COAT MIL-PRF-24647, TYPE I OR II, RED, 5-7 MILS -- &amp; -- ONE AC COAT MIL-PRF-24647, TYPE I OR II, 5 - 7 MILS</p> <p>SEE NOTES (8) &amp; (48)</p>			<p>ONE AF COAT MIL-PRF-24647, TYPE I OR II, 5 - 7 MILS</p> <p>SEE NOTES (2), (6), (8), (27), (48), &amp; (68)</p>	<p>ONE AF COAT MIL-PRF-24647, TYPE I OR II, 5 - 7 MILS</p> <p>SEE NOTES (2), (6), (8), (27) &amp; (48)</p>	<p>ONE COAT MIL-PRF-24635 TYPE V OR VI, CLASS 2, GRADE B OR C, COMPOSITION 2, LIGHT GRAY (LOW SOLAR ABSORPTION ONLY) TO BOOTTOPPING &amp; BELOW, 5 - 8 MILS --OR-- ONE COAT MIL-PRF-24635 TYPE V OR VI, CLASS 2, GRADE B OR C, COMPOSITION 1, LIGHT GRAY (LOW SOLAR ABSORPTION ONLY) TO BOOTTOPPING &amp; BELOW, 2-3 MILS --OR-- COMMERCIAL GRADE WHITE AF</p> <p>ONE COAT MIL-PRF-24635, COMPOSITION 2, OCEAN GRAY (LOW SOLAR ABSORPTION ONLY) ABOVE BOOTTOPPING, 5 - 8 MILS --OR-- ONE COAT MIL-PRF-24635, COMPOSITION 1, OCEAN GRAY (LOW SOLAR ABSORPTION ONLY) ABOVE BOOTTOPPING, 2 - 3 MILS</p> <p>SEE NOTE (1)</p>



TABLE ONE STEEL SURFACES  SURFACE SHIPS	LINE	A SURFACE PREPARATION	B PRIMER	C	D	E KEEL TO BOTTOM OF BOOTTOP	F BOOTTOP	G DRAFT MARKS
	2	NEAR WHITE METAL BLAST, NACE 2/SSPC-SP 10 - OR - WATERJETTING TO NACE/SSPC-SP WJ-2/M - OR - SSPC-SP 10/M (WAB)/NACE WAB-2/M   SEE NOTE (33)	ONE AC COAT MIL-PRF-24647, TYPE III, CLASSES 1, 2, AND 3, GRADE A, RED, 5 - 7 MILS -- & -- ONE AC COAT MIL-PRF-24647, TYPE III, CLASSES 1, 2, AND 3, GRADE A, 5 - 7 MILS  SEE NOTE (8)			ONE AF TIE COAT 3 - 5 MILS -- & -- ONE AF FULL COAT 5 - 7 MILS MIL-PRF-24647, TYPE III, CLASSES 1, 2, AND 3, GRADE A  SEE NOTES (2), (6), (8) & (68)	ONE AF TIE COAT 3 - 5 MILS -- & -- ONE AF FULL COAT 5 - 7 MILS MIL-PRF-24647, TYPE III, CLASSES 1, 2, AND 3, GRADE A  SEE NOTES (2), (6), & (8)	ONE COAT MIL-PRF-24635 TYPE V OR VI, CLASS 2, GRADE B OR C, COMPOSITION 2, LIGHT GRAY (LOW SOLAR ABSORPTION ONLY) TO BOOTTOPPING & BELOW, 5 - 8 MILS --OR-- ONE COAT MIL-PRF-24635 TYPE V OR VI, CLASS 2, GRADE B OR C, COMPOSITION 1, LIGHT GRAY (LOW SOLAR ABSORPTION ONLY) TO BOOTTOPPING & BELOW, 2-3 MILS --OR-- COMMERCIAL GRADE WHITE AF  ONE COAT MIL-PRF-24635, COMPOSITION 2, OCEAN GRAY (LOW SOLAR ABSORPTION ONLY) ABOVE BOOTTOPPING, 5 - 8 MILS --OR-- ONE COAT MIL-PRF-24635, COMPOSITION 1, OCEAN GRAY (LOW SOLAR ABSORPTION ONLY) ABOVE BOOTTOPPING, 2 - 3 MILS  SEE NOTE (1)

TABLE ONE STEEL SURFACES  SURFACE SHIPS	LINE	A SURFACE PREPARATION	B PRIMER	C	D	E KEEL TO BOTTOM OF BOOTTOP	F BOOTTOP	G DRAFT MARKS
UNDERWATER HULL (KEEL TO TOP OF BOOTTOP, INCLUDING PROPULSION SHAFT OUTBOARD BEARING VOIDS AND SEA CHESTS)  UP TO 7 YEARS SERVICE LIFE	3	NEAR WHITE METAL BLAST, NACE 2/SSPC-SP 10 - OR - WATERJETTING TO NACE/SSPC-SP WJ-2/M - OR - SSPC-SP 10/M (WAB)/NACE WAB-2/M  SEE NOTE (33)	ONE AC COAT MIL-PRF-24647, TYPE I OR II, RED, 5-7 MILS -- & -- ONE AC COAT MIL-PRF-24647, TYPE I OR II, 5 - 7 MILS  SEE NOTES (8) & (48)			ONE AF COAT MIL-PRF-24647, TYPE I OR II, BLACK -- & -- ONE AF COAT MIL-PRF-24647, TYPE I OR II, RED, 5 - 7 MILS/COAT  SEE NOTES (2), (6), (8), (48) & (68)	2 AF COATS MIL-PRF-24647, TYPE I OR II, BLACK, 5 - 7 MILS/COAT  SEE NOTES (2), (6), (8) & (48)	ONE COAT MIL-PRF-24635 TYPE V OR VI, CLASS 2, GRADE B OR C, COMPOSITION 2, LIGHT GRAY (LOW SOLAR ABSORPTION ONLY) TO BOOTTOPPING & BELOW, 5 - 8 MILS --OR-- ONE COAT MIL-PRF-24635 TYPE V OR VI, CLASS 2, GRADE B OR C, COMPOSITION 1, LIGHT GRAY (LOW SOLAR ABSORPTION ONLY) TO BOOTTOPPING & BELOW, 2-3 MILS --OR-- COMMERCIAL GRADE WHITE AF  ONE COAT MIL-PRF-24635, COMPOSITION 2, OCEAN GRAY (LOW SOLAR ABSORPTION ONLY) ABOVE BOOTTOPPING, 5 - 8 MILS --OR-- ONE COAT MIL-PRF-24635, COMPOSITION 1, OCEAN GRAY (LOW SOLAR ABSORPTION ONLY) ABOVE BOOTTOPPING, 2 - 3 MILS  SEE NOTE (1)

TABLE ONE STEEL SURFACES  SURFACE SHIPS	LINE	A SURFACE PREPARATION	B PRIMER	C	D	E KEEL TO BOTTOM OF BOOTTOP	F BOOTTOP	G DRAFT MARKS
	4	NEAR WHITE METAL BLAST, NACE 2/SSPC-SP 10 - OR - WATERJETTING TO NACE/SSPC-SP WJ-2/M - OR - SSPC-SP 10/M (WAB)/NACE WAB-2/M  SEE NOTE (33)	ONE AC COAT MIL-PRF-24647, TYPE III, CLASSES 1, 2, AND 3, GRADE A, RED, 5 - 7 MILS -- & -- ONE AC COAT MIL-PRF-24647, TYPE III, CLASSES 1, 2, AND 3, GRADE A, 5 - 7 MILS  SEE NOTE (8)			ONE AF TIE COAT 3 - 5 MILS -- & -- ONE AF FULL COAT 5 - 7 MILS MIL-PRF-24647, TYPE III, CLASSES 1, 2, AND 3, GRADE A  SEE NOTES (2), (6), (8) & (68)	ONE AF TIE COAT 3 - 5 MILS -- & -- ONE AF FULL COAT 5 - 7 MILS MIL-PRF-24647, TYPE III, CLASSES 1, 2, AND 3, GRADE A  SEE NOTES (2), (6), & (8)	ONE COAT MIL-PRF-24635 TYPE V OR VI, CLASS 2, GRADE B OR C, COMPOSITION 2, LIGHT GRAY (LOW SOLAR ABSORPTION ONLY) TO BOOTTOPPING & BELOW, 5 - 8 MILS --OR-- ONE COAT MIL-PRF-24635 TYPE V OR VI, CLASS 2, GRADE B OR C, COMPOSITION 1, LIGHT GRAY (LOW SOLAR ABSORPTION ONLY) TO BOOTTOPPING & BELOW, 2-3 MILS --OR-- COMMERCIAL GRADE WHITE AF  ONE COAT MIL-PRF-24635, COMPOSITION 2, OCEAN GRAY (LOW SOLAR ABSORPTION ONLY) ABOVE BOOTTOPPING, 5 - 8 MILS --OR-- ONE COAT MIL-PRF-24635, COMPOSITION 1, OCEAN GRAY (LOW SOLAR ABSORPTION ONLY) ABOVE BOOTTOPPING, 2 - 3 MILS  SEE NOTE (1)

TABLE ONE STEEL SURFACES  SURFACE SHIPS	LINE	A SURFACE PREPARATION	B PRIMER	C	D	E KEEL TO BOTTOM OF BOOTTOP	F BOOTTOP	G DRAFT MARKS
<p>UNDERWATER HULL (KEEL TO TOP OF BOOTTOP, INCLUDING PROPULSION SHAFT OUTBOARD BEARING VOIDS AND SEA CHESTS)</p> <p>UP TO 12 YEARS SERVICE LIFE</p>	5	<p>NEAR WHITE METAL BLAST, NACE 2/SSPC-SP 10 - OR - WATERJETTING TO NACE/SSPC-SP WJ-2/M - OR - SSPC-SP 10/M (WAB)/NACE WAB-2/M</p> <p>SEE NOTE (33)</p>	<p>ONE AC COAT MIL-PRF-24647, TYPE I OR II, 5-7 MILS -- &amp; -- ONE AC COAT MIL-PRF-24647, TYPE I OR II, 5 - 7 MILS</p> <p>SEE NOTES (8) &amp; (48)</p>			<p>ONE AF COAT MIL-PRF-24647, TYPE II, RED -- &amp; -- ONE AF COAT MIL-PRF-24647, TYPE II, BLACK -- &amp; -- ONE AF COAT MIL-PRF-24647, TYPE II, RED, 5 - 7 MILS/COAT</p> <p>SEE NOTES (2), (6), (8), (48) &amp; (68)</p>	<p>ONE AF COAT MIL-PRF-24647, TYPE II, RED AND 2 AF COATS MIL-PRF-24647, TYPE II, BLACK, 5 - 7 MILS/COAT</p> <p>SEE NOTES (2), (6), (8) &amp; (48)</p>	<p>ONE COAT MIL-PRF-24635 TYPE V OR VI, CLASS 2, GRADE B OR C, COMPOSITION 2, LIGHT GRAY (LOW SOLAR ABSORPTION ONLY) TO BOOTTOPPING &amp; BELOW, 5 - 8 MILS --OR-- ONE COAT MIL-PRF-24635 TYPE V OR VI, CLASS 2, GRADE B OR C, COMPOSITION 1, LIGHT GRAY (LOW SOLAR ABSORPTION ONLY) TO BOOTTOPPING &amp; BELOW, 2-3 MILS --OR-- COMMERCIAL GRADE WHITE AF</p> <p>ONE COAT MIL-PRF-24635, COMPOSITION 2, OCEAN GRAY (LOW SOLAR ABSORPTION ONLY) ABOVE BOOTTOPPING, 5 - 8 MILS --OR-- ONE COAT MIL-PRF-24635, COMPOSITION 1, OCEAN GRAY (LOW SOLAR ABSORPTION ONLY) ABOVE BOOTTOPPING, 2 - 3 MILS</p> <p>SEE NOTE (1)</p>

TABLE ONE STEEL SURFACES	LINE	A SURFACE PREPARATION	B PRIMER	C	D	E KEEL TO BOTTOM OF BOOTTOP	F BOOTTOP	G DRAFT MARKS
SURFACE SHIPS								
RR EXISTING FIN STABILIZERS  SEE NOTES (48) & (52)	6	BRUSH-OFF BLAST TO NACE 4/SSPC-SP 7	ONE AC COAT MIL-PRF-24647, TYPE I OR II, RED, 5-7 MILS -- & -- ONE AC COAT MIL-PRF-24647, TYPE I OR II, 5 - 7 MILS/COAT  SEE NOTES (8) & (48)			ONE AF COAT MIL-PRF- 24647, TYPE II, RED -- & -- ONE AF COAT MIL-PRF- 24647, TYPE II, BLACK -- & -- ONE AF COAT MIL-PRF- 24647, TYPE II, RED, 5 - 7 MILS/COAT  SEE NOTES (2), (6), (8), (48) & (68)		
REFURBISHED FIN STABILIZERS  SEE NOTE (48)	7	HAND TOOL CLEAN TO SSPC-SP 2	ONE AC COAT MIL-PRF-24647, TYPE I OR II, RED, 5-7 MILS -- & -- ONE AC COAT MIL-PRF-24647, TYPE I OR II, 5 - 7 MILS/COAT  SEE NOTES (8) & (48)			ONE AF COAT MIL-PRF- 24647, TYPE II, RED -- & -- ONE AF COAT MIL-PRF- 24647, TYPE II, BLACK -- & -- ONE AF COAT MIL-PRF- 24647, TYPE II, RED, 5 - 7 MILS/COAT  SEE NOTES (2), (6), (8), (48) & (68)		
UNDERWATER HULL (DIELECTRIC SHIELDS)	8	WHITE METAL BLAST, NACE 1/SSPC-SP 5	TROWELABLE DIELECTRIC SHIELD  INNER SHIELD: ONE COAT EVOQUA WATER TECHNOLOGIES LLC CAPASTIC™, PART NO. 35524 (W3T106410), 100 MILS MIN  OUTER SHIELD: ONE COAT EVOQUA WATER TECHNOLOGIES LLC, CAPASTIC™, PART NO. 35524 (W3T106410), 22 MILS MIN  SEE NOTES (10), (11), & (81)		ANTI- CORROSIVE PAINT SAME AS SURROUNDING HULL EXCEPT ONE COAT	ANTIFOULING PAINT SAME AS SURROUNDING HULL  SEE NOTES (2), (6) & (8)		

TABLE ONE STEEL SURFACES  SURFACE SHIPS	LINE	A SURFACE PREPARATION	B PRIMER	C	D	E KEEL TO BOTTOM OF BOOTTOP	F BOOTTOP	G DRAFT MARKS
	9	WHITE METAL BLAST, NACE 1/SSPC-SP 5	SPRAYABLE DIELECTRIC SHIELD:  ONE COAT INTERNATIONAL INTERLINE 624 BUFF --OR-- SHERWIN-WILLIAMS NOVAPLATE UHS PRIMER AT 10 MILS MINIMUM DFT (OUT TO 7 FEET).  SEE NOTES (11) & (81)	ONE COAT INTERNATIONAL INTERLINE 624 --OR-- SHERWIN-WILLIAMS NOVAPLATE UHS AT 30 MILS MINIMUM DFT (OUT TO 6.5 FEET). --&-- ONE COAT INTERNATIONAL INTERLINE 624 --OR-- SHERWIN-WILLIAMS NOVAPLATE UHS AT 30 MILS MINIMUM DFT (OUT TO 6 FEET WITH A TOTAL MINIMUM DFT OF 70 MILS).  SEE NOTES (11) & (81)	ANTI- CORROSIVE PAINT SAME AS SURROUNDING HULL EXCEPT ONE COAT	ANTIFOULING PAINT SAME AS SURROUNDING HULL           SEE NOTES (2), (6) & (8)		
EXPOSED AREAS OF OUTBOARD SHAFTING COVERED BY GLASS- REINFORCED PLASTIC (GRP) AND SHAFT FLANGES	10	HAND TOOL CLEAN TO SSPC-SP 2	ONE AC COAT MIL-PRF-24647, TYPE I OR II, 5 - 7 MILS  SEE NOTES (8) & (48)			ANTIFOULING PAINT SAME AS SURROUNDING HULL  SEE NOTES (6), (8) & (68)		

TABLE ONE ALUMINUM SURFACES  SURFACE SHIPS	LINE	A SURFACE PREPARATION	B PRIMER	C	D	E KEEL TO BOTTOM OF BOOTTOP	F BOOTTOP	G DRAFT MARKS
UNDERWATER HULL (KEEL TO TOP OF BOOTTOP, INCLUDING PROPULSION SHAFT OUTBOARD BEARING VOIDS AND SEA CHESTS)	11	THOROUGH ABRASIVE BLAST CLEANING OF NON-FERROUS METALS, SSPC-SP 17 USING MIL-A-22262 QUALIFIED MEDIA (EXCLUDING COAL SLAG) OR ALUMINUM OXIDE - OR - WATERJETTING TO NACE/SSPC-SP WJ-2  SEE NOTES (90)	ONE AC COAT RED, WITHIN 6 HOURS AFTER SURFACE PREPARATION, 5-7 MILS --&-- ONE AC COAT MIL-PRF-24647, TYPE III, CLASSES 1, 2, AND 3, GRADE A, APPLICATION I, 5 - 7 MILS  SEE NOTES (8) & (48)			ONE AF TIE COAT MIL-PRF-24647, TYPE III, CLASSES 1, 2, AND 3, GRADE A, APPLICATION I, 3 - 5 MILS --&-- ONE AF FULL COAT MIL-PRF-24647, TYPE III, CLASSES 1, 2, AND 3, GRADE A, APPLICATION I, 5 - 7 MILS, HAZE GRAY  SEE NOTES (2), (6), (8), (48) & (68)	ONE AF TIE COAT MIL-PRF-24647, TYPE III, CLASSES 1, 2, AND 3, GRADE A, APPLICATION I, 3 - 5 MILS --&-- ONE AF FULL COAT MIL-PRF-24647, TYPE III, CLASSES 1, 2, AND 3, GRADE A, APPLICATION I, 5 - 7 MILS, HAZE GRAY  SEE NOTES (2), (6), (8), & (48)	ONE AF TIE COAT MIL-PRF-24647, TYPE III, CLASSES 1, 2, AND 3, GRADE A, APPLICATION I, 3 - 5 MILS --&-- ONE AF FULL COAT MIL-PRF-24647, TYPE III, CLASSES 1, 2, AND 3, GRADE A, APPLICATION I, 5 - 7 MILS, BLACK  SEE NOTES (1) & (48)
	12	THOROUGH ABRASIVE BLAST CLEANING OF NON-FERROUS METALS, SSPC-SP 17 USING MIL-A-22262 QUALIFIED MEDIA (EXCLUDING COAL SLAG) OR ALUMINUM OXIDE - OR - WATERJETTING TO NACE/SSPC-SP WJ-2  SEE NOTES (90)	ONE AC COAT MIL-PRF-24647, TYPE I, RED WITHIN 6 HOURS AFTER SURFACE PREPARATION, 5-7 MILS -- & -- ONE AC COAT MIL-PRF-24647, TYPE I, 5 - 7 MILS/COAT  SEE NOTES (8) & (48)			ONE AF COAT MIL-PRF-24647, TYPE I, BLACK -- & -- ONE AF COAT MIL-PRF-24647, TYPE I, RED, 5 - 7 MILS/COAT  SEE NOTES (2), (6), (8), (48) & (68)	2 AF COATS MIL-PRF-24647, TYPE I, BLACK, 5 - 7 MILS/COAT  SEE NOTES (2), (6), (8), & (48)	2 AF COATS MIL-PRF-24647, TYPE I, BLACK, 5 - 7 MILS/COAT  SEE NOTES (1) & (48)
UNDERWATER HULL  APPLIES TO EMBARKED BOATS AND CRAFT ONLY	13	THOROUGH ABRASIVE BLAST CLEANING OF NON-FERROUS METALS, SSPC-SP 17 USING MIL-A-22262 QUALIFIED MEDIA (EXCLUDING COAL SLAG) OR ALUMINUM OXIDE - OR - WATERJETTING TO NACE/SSPC-SP WJ-2  SEE NOTES (90)	ONE AC COAT MIL-PRF-24647, TYPE I, RED WITHIN 6 HOURS AFTER SURFACE PREPARATION, 5-7 MILS -- & -- ONE AC COAT MIL-PRF-24647, TYPE I, 5 - 7 MILS/COAT  SEE NOTES (8) & (48)			ONE AF COAT MIL-PRF-24647, TYPE I, BLACK -- & -- ONE AF COAT MIL-PRF-24647, TYPE I, RED, 5 - 7 MILS/COAT  SEE NOTES (2), (6), (8), (48) & (68)	2 AF COATS MIL-PRF-24647, TYPE I, BLACK, 5 - 7 MILS/COAT  SEE NOTES (2), (6), (8), & (48)	2 AF COATS MIL-PRF-24647, TYPE I, BLACK, 5 - 7 MILS/COAT  SEE NOTES (1) & (48)

TABLE ONE GRP SURFACES	LINE	A SURFACE PREPARATION	B PRIMER	C	D	E KEEL TO BOTTOM OF BOOTTOP	F BOOTTOP	G DRAFT MARKS
<b>SURFACE SHIPS</b>								
UNDERWATER HULL (KEEL TO TOP OF BOOTTOP, INCLUDING PROPULSION SHAFT OUTBOARD BEARING VOIDS AND SEA CHESTS)  UP TO 3 YEARS SERVICE LIFE	14	HIGH PRESSURE WASH TO REMOVE MARINE GROWTH & LOOSE PAINT - OR - TOUCH-UP OR REMOVAL OF PAINT SYSTEM TO SOUND AC COAT BY LIGHT ABRASIVE BLASTING WITH WALNUT SHELLS -- & -- SPOT CLEAN, CHAP 631, PARA 631-5.2.6  SEE NOTE (21)	ONE AC COAT MIL-PRF-24647, TYPE III, CLASSES 1, 2, AND 3, GRADE A, 5 - 7 MILS  SEE NOTE (8)			ONE AF TIE COAT 3 - 5 MILS -- & -- ONE AF FULL COAT 5 - 7 MILS MIL-PRF-24647, TYPE III, CLASSES 1, 2, AND 3, GRADE A  SEE NOTES (2), (6), (8) & (68)	ONE AF TIE COAT 3 - 5 MILS -- & -- ONE AF FULL COAT 5 - 7 MILS MIL-PRF-24647, TYPE III, CLASSES 1, 2, AND 3, GRADE A  SEE NOTES (2), (6) & (8)	ONE COAT MIL-PRF-24635 LIGHT GRAY (LOW SOLAR ABSORPTION ONLY) TO BOOTTOPPING & BELOW, 5 - 8 MILS  ONE COAT MIL-PRF-24635 OCEAN GRAY (LOW SOLAR ABSORPTION ONLY) ABOVE BOOTTOPPING, 5 - 8 MILS  SEE NOTE (1)
	15	HIGH PRESSURE WASH TO REMOVE MARINE GROWTH & LOOSE PAINT - OR - TOUCH-UP OR REMOVAL OF PAINT SYSTEM TO SOUND AC COAT BY LIGHT ABRASIVE BLASTING WITH WALNUT SHELLS -- & -- SPOT CLEAN, CHAP 631, PARA 631-5.2.6  SEE NOTE (21)	ONE AC COAT MIL-PRF-24647, TYPE I OR II, -5 - 7 MILS  SEE NOTES (8) & (48)			ONE AF COAT MIL-PRF-24647, TYPE I OR II, RED, 5 - 7 MILS  SEE NOTES (2), (6), (8), (48) & (68)	ONE AF COAT MIL-PRF-24647, TYPE I OR II, BLACK, 5 - 7 MILS  SEE NOTES (2), (6), (8) & (48)	ONE COAT MIL-PRF-24635 LIGHT GRAY (LOW SOLAR ABSORPTION ONLY) TO BOOTTOPPING & BELOW, 5 - 8 MILS  ONE COAT MIL-PRF-24635 OCEAN GRAY (LOW SOLAR ABSORPTION ONLY) ABOVE BOOTTOPPING, 5 - 8 MILS  SEE NOTE (1)
UNDERWATER HULL (KEEL TO TOP OF BOOTTOP, INCLUDING PROPULSION SHAFT OUTBOARD BEARING VOIDS AND SEA CHESTS)  UP TO 7 YEARS SERVICE LIFE	16	HIGH PRESSURE WASH TO REMOVE MARINE GROWTH & LOOSE PAINT - OR - TOUCH-UP OR REMOVAL OF PAINT SYSTEM TO SOUND AC COAT BY LIGHT ABRASIVE BLASTING WITH WALNUT SHELLS -- & -- SPOT CLEAN, CHAP 631, PARA 631-5.2.6  SEE NOTE (21)	ONE AC COAT MIL-PRF-24647, TYPE I OR II, -5 - 7 MILS  SEE NOTES (8) & (48)			ONE AF COAT MIL-PRF-24647, TYPE I OR II, BLACK -- & -- ONE AF COAT MIL-PRF-24647, TYPE I OR II, RED, 5 - 7 MILS/COAT  SEE NOTES (2), (6), (8), (48) & (68)	2 AF COATS MIL-PRF-24647, TYPE I OR II, BLACK, 5 - 7 MILS/COAT  SEE NOTES (2), (6), (8) & (48)	ONE COAT MIL-PRF-24635 LIGHT GRAY (LOW SOLAR ABSORPTION ONLY) TO BOOTTOPPING & BELOW, 5 - 8 MILS  ONE COAT MIL-PRF-24635 OCEAN GRAY (LOW SOLAR ABSORPTION ONLY) ABOVE BOOTTOPPING, 5 - 8 MILS  SEE NOTE (1)
	17	HIGH PRESSURE WASH TO REMOVE MARINE GROWTH & LOOSE PAINT - OR -	ONE AC COAT MIL-PRF-24647, TYPE III, CLASSES 1, 2, AND 3, GRADE A, 5 - 7 MILS			ONE AF TIE COAT 3 - 5 MILS -- & -- ONE AF FULL COAT 5 - 7 MILS MIL-PRF-24647,	ONE AF TIE COAT 3 - 5 MILS -- & -- ONE AF FULL COAT 5 - 7 MILS MIL-PRF-24647, TYPE III, CLASSES 1, 2, AND 3, GRADE A	ONE COAT MIL-PRF-24635 LIGHT GRAY (LOW SOLAR ABSORPTION ONLY) TO BOOTTOPPING & BELOW, 5 - 8 MILS



TABLE ONE GRP SURFACES	LINE	A SURFACE PREPARATION	B PRIMER	C	D	E KEEL TO BOTTOM OF BOOTTOP	F BOOTTOP	G DRAFT MARKS
SURFACE SHIPS		TOUCH-UP OR REMOVAL OF PAINT SYSTEM TO SOUND AC COAT BY LIGHT ABRASIVE BLASTING WITH WALNUT SHELLS -- & -- SPOT CLEAN, CHAP 631, PARA 631-5.2.6  SEE NOTE (21)	SEE NOTE (8)			TYPE III, CLASSES 1, 2, AND 3, GRADE A  SEE NOTES (2), (6), (8) & (68)	SEE NOTES (2), (6) & (8)	ONE COAT MIL-PRF-24635 OCEAN GRAY (LOW SOLAR ABSORPTION ONLY) ABOVE BOOTTOPPING, 5 - 8 MILS  SEE NOTE (1)
UNDERWATER HULL (KEEL TO TOP OF BOOTTOP, INCLUDING PROPULSION SHAFT OUTBOARD BEARING VOIDS AND SEA CHESTS)  UP TO 12 YEARS SERVICE LIFE	18	HIGH PRESSURE WASH TO REMOVE MARINE GROWTH & LOOSE PAINT - OR - TOUCH-UP OR REMOVAL OF PAINT SYSTEM TO SOUND AC COAT BY LIGHT ABRASIVE BLASTING WITH WALNUT SHELLS -- & -- SPOT CLEAN, CHAP 631, PARA 631-5.2.6  SEE NOTE (21)	ONE AC COAT MIL-PRF-24647, TYPE I OR II, -5 - 7 MILS  SEE NOTES (8) & (48)			ONE AF COAT MIL-PRF-24647, TYPE II, RED -- & -- ONE AF COAT MIL-PRF-24647, TYPE II, BLACK -- & -- ONE COAT MIL-PRF-24647, TYPE II, RED, 5 - 7 MILS/COAT  SEE NOTES (2), (6), (8), (48) & (68)	ONE AF COAT RED AND 2 AF COATS BLACK MIL-PRF-24647, TYPE II, 5 - 7 MILS/COAT  SEE NOTES (2), (6), (8) & (48)	ONE COAT MIL-PRF-24635 LIGHT GRAY (LOW SOLAR ABSORPTION ONLY) TO BOOTTOPPING & BELOW, 5 - 8 MILS  ONE COAT MIL-PRF-24635 OCEAN GRAY (LOW SOLAR ABSORPTION ONLY) ABOVE BOOTTOPPING, 5 - 8 MILS  SEE NOTE (1)
UNDERWATER HULL APPLIES TO EMBARKED BOATS AND CRAFT ONLY	19	HIGH PRESSURE WASH TO REMOVE MARINE GROWTH & LOOSE PAINT - OR - TOUCH-UP OR REMOVAL OF PAINT SYSTEM TO SOUND AC COAT BY LIGHT ABRASIVE BLASTING WITH WALNUT SHELLS -- & -- SPOT CLEAN, CHAP 631, PARA 631-5.2.6  SEE NOTE (21)	ONE AC COAT MIL-PRF-24647, TYPE I OR II, -5 - 7 MILS  SEE NOTES (8) & (48)			ONE AF COAT MIL-PRF-24647, TYPE I, GRAY, 5-7 MILS  SEE NOTES (6), (8) & (48)	ONE AF COAT MIL-PRF-24647, TYPE I, GRAY, 5 - 7 MILS  SEE NOTES (6), (8) & (48)	ONE COAT MIL-PRF-24635 LIGHT GRAY (LOW SOLAR ABSORPTION ONLY) TO BOOTTOPPING & BELOW, 5 - 8 MILS  ONE COAT MIL-PRF-24635 OCEAN GRAY (LOW SOLAR ABSORPTION ONLY) ABOVE BOOTTOPPING, 5 - 8 MILS  SEE NOTE (1)

TABLE ONE GRP SURFACES  SURFACE SHIPS	LINE	A SURFACE PREPARATION	B PRIMER	C	D	E KEEL TO BOTTOM OF BOOTTOP	F BOOTTOP	G DRAFT MARKS
UNDERWATER HULL APPENDAGES ON MINESWEEPERS ONLY	20	NEAR WHITE METAL BLAST USING GARNET OR ALUMINUM OXIDE - OR - WATERJETTING TO NACE/SSPC-SP WJ-2	ONE FULL COAT --- & --- ONE STRIPE COAT --- & --- ONE FULL COAT --- & --- ONE STRIPE COAT --- & --- ONE FULL COAT MIL-DTL-24441 TYPE IV , 3 - 5 MILS/COAT  SEE NOTE (40)	ANTIFOULING PAINT SAME AS SURROUNDING HULL				
MINESWEEPER PROPULSION SHAFTS	21	NEAR WHITE METAL BLAST USING GARNET OR ALUMINUM OXIDE - OR - WATERJETTING TO NACE/SSPC-SP WJ-2	ONE AC COAT MIL-PRF-24647, TYPE I OR II, -5 - 7 MILS  SEE NOTES (8) & (48)			ONE AF COAT MIL-PRF- 24647, TYPE II, RED -- & -- ONE AF COAT MIL-PRF- 24647, TYPE II, BLACK -- & -- ONE COAT MIL-PRF- 24647, TYPE II, RED, 5 - 7 MILS/COAT  SEE NOTES (2), (6), (8), (48) & (68)		
SONAR TRANSDUCER TR- 192B/UQN-1 ON MINESWEEPERS ONLY	22	POWER TOOL CLEAN TO BARE METAL PER SSPC-SP 11	ONE FULL COAT --- & --- ONE STRIPE COAT --- & --- ONE FULL COAT --- & --- ONE STRIPE COAT --- & --- ONE FULL COAT MIL-DTL-24441 TYPE IV , 3 - 5 MILS/COAT  SEE NOTE (40)	ANTIFOULING PAINT SAME AS SURROUNDING HULL				

TABLE ONE WOOD SURFACES  SURFACE SHIPS	LINE	A SURFACE PREPARATION	B PRIMER	C	D	E KEEL TO BOTTOM OF BOOTTOP	F BOOTTOP	G DRAFT MARKS
UNDERWATER HULL	23	BRUSH-OFF BLAST TO REMOVE LOOSE & DETERIORATED COATINGS - OR - HIGH PRESSURE WASH TO REMOVE MARINE GROWTH & LOOSE PAINT  SEE NOTE (20)	KEEL TO 6 INCHES ABOVE UPPER BOOTTOP LIMIT  ONE AC COAT MIL-PRF-24647, TYPE I OR II, 5 - 7 MILS  SEE NOTES (8) & (48)			ONE AF COAT MIL-PRF-24647, TYPE I OR II, 5 - 7 MILS  SEE NOTES (2), (6), (8), (27), (48) & (68)	ONE AF COAT MIL-PRF-24647, TYPE I OR II, 5 - 7 MILS  SEE NOTES (2), (6), (8), (27) & (48)	ONE COAT MIL-PRF-24635 (LOW SOLAR ABSORPTION ONLY) LIGHT GRAY, TO BOOTTOPPING & BELOW, 5 - 8 MILS  ONE COAT MIL-PRF-24635 (LOW SOLAR ABSORPTION ONLY) OCEAN GRAY, ABOVE BOOTTOPPING, 5 - 8 MILS  SEE NOTES (1) & (6)

TABLE 2 STEEL SURFACES  SURFACE SHIPS	LINE	A SURFACE PREPARATION	B PRIMER	C	D	E HORIZONTAL SURFACES DECKS & FITTINGS	F MASTS & STACKS EXPOSED TO GASES	G VERTICAL SURFACES
EXTERIOR SURFACES ABOVE BOOTTOP WITH EXCEPTION OF AREAS RECEIVING NONSKID & WELL DECK OVERHEAD AREAS  SEE NOTES (2), (3), (33) & (70)	1	NEAR WHITE METAL BLAST, NACE 2/SSPC-SP 10 - OR - WATERJETTING TO NACE/SSPC-SP WJ-2/M - OR - SSPC-SP 10/M (WAB)/NACE WAB-2/M	ONE COAT MIL-PRF-23236, TYPE V OR VI, CLASS 5 OR 7, 4 - 8 MILS --OR-- ONE FULL COAT ANTICORROSIVE MIL-PRF-24647, TYPE I OR II, 5 - 7 MILS  SEE NOTE (8)	ONE STRIPE COAT MIL-PRF-23236, TYPE V OR VI, CLASS 5 OR 7, 4 - 8 MILS/COAT --OR-- ONE STRIPE COAT ANTICORROSIVE MIL-PRF-24647, TYPE I OR II, 5 - 7 MILS  SEE NOTE (8)		ONE COAT DECK GRAY MIL-PRF-24635 TYPE V OR VI, CLASS 2, GRADE B OR C, COMPOSITION 2, 5 - 8 MILS  SEE NOTES (47), (64), & (86)	ONE COAT HAZE GRAY MIL-PRF-24635 TYPE V OR VI, CLASS 2, GRADE B OR C, COMPOSITION 2, 5 - 8 MILS  SEE NOTES (42), (64), (85), & (86)	ONE COAT HAZE GRAY MIL-PRF-24635 TYPE V OR VI, CLASS 2, GRADE B OR C, COMPOSITION 2, 5 - 8 MILS  PAINT DESIGNATIONS & MARKINGS MIL-PRF-24635 COMPOSITION 2, 5 - 8 MILS  SEE NOTES (43), (47), (64), (85), & (86)
	1A	NEAR WHITE METAL BLAST, NACE 2/SSPC-SP 10 - OR - WATERJETTING TO NACE/SSPC-SP WJ-2/M - OR - SSPC-SP 10/M (WAB)/NACE WAB-2/M	ONE COAT MIL-PRF-23236, TYPE V OR VI, CLASS 5 OR 7, 4 - 8 MILS --OR-- ONE FULL COAT ANTICORROSIVE MIL-PRF-24647, TYPE I OR II, 5 - 7 MILS  SEE NOTE (8)	ONE STRIPE COAT -- & -- ONE FULL COAT MIL-PRF-23236, TYPE V OR VI, CLASS 5 OR 7, 4 - 8 MILS/COAT		ONE COAT DECK GRAY MIL-PRF-24635 TYPE V OR VI, CLASS 2, GRADE B OR C, COMPOSITION 1, 2 - 3 MILS  SEE NOTES (47), (64), & (86)	ONE COAT HAZE GRAY MIL-PRF-24635 TYPE V OR VI, CLASS 2, GRADE B OR C, COMPOSITION 1, 2 - 3 MILS - OR - MIL-PRF-24763, TYPE II OR III, CLASS 2, GRADE B, 2 - 4 MILS  SEE NOTES (42), (64), (85), & (86)	ONE COAT HAZE GRAY MIL-PRF-24635 TYPE V OR VI, CLASS 2, GRADE B OR C, COMPOSITION 1, 2 - 3 MILS - OR - MIL-PRF-24763, TYPE II OR III, CLASS 2, GRADE B, 2 - 4 MILS  PAINT DESIGNATIONS & MARKINGS MIL-PRF-24635 COMPOSITION 1, 2 - 3 MILS  SEE NOTES (43), (47), (64), (85), & (86)

TABLE 2 STEEL SURFACES  SURFACE SHIPS	LINE	A SURFACE PREPARATION	B PRIMER	C	D	E HORIZONTAL SURFACES DECKS & FITTINGS	F MASTS & STACKS EXPOSED TO GASES	G VERTICAL SURFACES
	2	NEAR WHITE METAL BLAST, NACE 2/SSPC-SP 10 - OR - WATERJETTING TO NACE/SSPC-SP WJ-2/M - OR - SSPC-SP 10/M (WAB)/NACE WAB-2/M	ONE FULL COAT MIL- PRF-23236, TYPE VII, CLASS 5 OR 7, 4 - 8 MILS	ONE FULL COAT MIL-PRF-23236, TYPE VII, CLASS 5 OR 7, 10 - 12 MILS		ONE COAT DECK GRAY MIL- PRF-24635 TYPE V OR VI, CLASS 2, GRADE B OR C, COMPOSITION 2, 5 - 8 MILS --OR-- ONE COAT DECK GRAY MIL- PRF-24635 TYPE V OR VI, CLASS 2, GRADE B OR C, COMPOSITION 1, 2 - 3 MILS  SEE NOTES (47), (64), & (86)	ONE COAT HAZE GRAY MIL-PRF-24635 TYPE V OR VI, CLASS 2, GRADE B OR C, COMPOSITION 2, 5 - 8 MILS - OR - MIL-PRF-24763, TYPE II OR III, CLASS 2, GRADE B, 2 - 4 MILS --OR-- ONE COAT HAZE GRAY MIL-PRF-24635 TYPE V OR VI, CLASS 2, GRADE B OR C, COMPOSITION 1, 2 - 3 MILS  SEE NOTES (42), (64), (85), & (86)	ONE COAT HAZE GRAY MIL-PRF-24635 TYPE V OR VI, CLASS 2, GRADE B OR C, COMPOSITION 2, 5 - 8 MILS - OR - MIL-PRF-24763, TYPE II OR III, CLASS 2, GRADE B, 2 - 4 MILS --OR-- ONE COAT HAZE GRAY MIL-PRF-24635 TYPE V OR VI, CLASS 2, GRADE B OR C, COMPOSITION 1, 2 - 3 MILS  PAINT DESIGNATIONS & MARKINGS MIL-PRF- 24635 COMPOSITION 2, 5 - 8 MILS OR MIL- PRF-24635 COMPOSITION 1, 2 - 3 MILS  SEE NOTES (43), (47), (64), (85), & (86)



TABLE 2 STEEL SURFACES  SURFACE SHIPS	LINE	A SURFACE PREPARATION	B PRIMER	C	D	E HORIZONTAL SURFACES DECKS & FITTINGS	F MASTS & STACKS EXPOSED TO GASES	G VERTICAL SURFACES
	4	NEAR WHITE METAL BLAST, NACE 2/SSPC-SP 10 - OR - WATERJETTING TO NACE/SSPC-SP WJ-2/M - OR - SSPC-SP 10/M (WAB)/NACE WAB-2/M	ONE FULL COAT ANTICORROSIVE MIL-PRF-24647, TYPE I OR II, 5 - 7 MILS  SEE NOTE (8)	ONE STRIPE COAT -- & -- ONE FULL COAT ANTICORROSIVE MIL-PRF-24647, TYPE I OR II, 5 - 7 MILS  SEE NOTE (8)		ONE COAT DECK GRAY MIL-PRF-24635 TYPE V OR VI, CLASS 2, GRADE B OR C, COMPOSITION 1, 2 -3 MILS  SEE NOTES (47), (64), & (86)	ONE COAT HAZE GRAY MIL-PRF-24635 TYPE V OR VI, CLASS 2, GRADE B OR C, COMPOSITION 1, 2 - 3 MILS - OR - MIL-PRF-24763, TYPE II OR III, CLASS 2, GRADE B, 2 - 4 MILS  SEE NOTES (42), (64), (85), & (86)	ONE COAT HAZE GRAY MIL-PRF-24635 TYPE V OR VI, CLASS 2, GRADE B OR C, COMPOSITION 1, 2 - 3 MILS - OR - MIL-PRF-24763, TYPE II OR III, CLASS 2, GRADE B, 2 - 4 MILS  PAINT DESIGNATIONS & MARKINGS MIL-PRF-24635 COMPOSITION 1, 2 -3 MILS  SEE NOTES (43), (47), (64), (85), & (86)
EXTERIOR SURFACES TO BE INSULATED	5	NEAR WHITE METAL BLAST, NACE 2/SSPC-SP 10 - OR - WATERJETTING TO NACE/SSPC-SP WJ-2/M - OR - SSPC-SP 10/M (WAB)/NACE WAB-2/M	ONE COAT MIL-PRF-23236, TYPE V OR VI, CLASS 5 OR 7, 4 - 8 MILS	ONE STRIPE COAT MIL-PRF-23236, TYPE V OR VI, CLASS 5 OR 7, 4 - 8 MILS/COAT	ONE COAT MIL-PRF-23236, TYPE V OR VI, CLASS 5 OR 7, 4 - 8 MILS --OR-- ONE COAT MIL-PRF-24635, TYPE V OR VI, CLASS 2, GRADE B OR C, COMPOSITION 2, 5 - 8 MILS  FOLLOWED BY INSULATION  SEE NOTES (64), & (86)	ONE COAT HAZE GRAY, MIL-PRF-24635, TYPE V, CLASS 2 GRADE B, COMPOSITION 2, 5 - 8 MILS		ONE COAT HAZE GRAY, MIL-PRF-24635, TYPE V, CLASS 2, GRADE B, COMPOSITION 2, 5 - 8 MILS
	5A	NEAR WHITE METAL BLAST, NACE 2/SSPC-SP 10 - OR - WATERJETTING TO NACE/SSPC-SP WJ-2/M - OR - SSPC-SP 10/M (WAB)/NACE WAB-2/M	ONE COAT MIL-PRF-23236, TYPE V OR VI, CLASS 5 OR 7, 4 - 8 MILS	ONE STRIPE COAT -- & -- ONE FULL COAT MIL-PRF-23236, TYPE V OR VI, CLASS 5 OR 7, 4 - 8 MILS/COAT	ONE COAT MIL-PRF-24635, TYPE V OR VI, CLASS 2, GRADE B OR C, COMPOSITION 1, 2 - 3 MILS  FOLLOWED BY INSULATION  SEE NOTES (64), & (86)	ONE COAT HAZE GRAY, MIL-PRF-24635, TYPE V, CLASS 2 GRADE B, COMPOSITION 1, 2 - 3 MILS		ONE COAT HAZE GRAY, MIL-PRF-24635, TYPE V, CLASS 2, GRADE B, COMPOSITION 1, 2 - 3 MILS

TABLE 2 STEEL SURFACES  SURFACE SHIPS	LINE	A SURFACE PREPARATION	B PRIMER	C	D	E HORIZONTAL SURFACES DECKS & FITTINGS	F MASTS & STACKS EXPOSED TO GASES	G VERTICAL SURFACES
	6	NEAR WHITE METAL BLAST, NACE 2/SSPC-SP 10 - OR - WATERJETTING TO NACE/SSPC-SP WJ-2/M - OR - SSPC-SP 10/M (WAB)/NACE WAB-2/M		ONE FULL COAT MIL-PRF-23236, TYPE VII, CLASS 5 OR 7, 10 - 12 MILS	ONE COAT MIL-PRF-23236, TYPE VII, CLASS 5 OR 7, 4 - 8 MILS --OR-- ONE COAT MIL-PRF-24635, TYPE V OR VI, CLASS 2, GRADE B OR C, COMPOSITION 2, 5 - 8 MILS --OR-- ONE COAT MIL-PRF-24635, TYPE V OR VI, CLASS 2, GRADE B OR C, COMPOSITION 1, 2 - 3 MILS  FOLLOWED BY INSULATION  SEE NOTES (64), & (86)	ONE COAT DECK GRAY, MIL- PRF-24635, TYPE V, CLASS 2 GRADE B, COMPOSITION 2, 5 - 8 MILS --OR-- ONE COAT DECK GRAY, MIL- PRF-24635, TYPE V, CLASS 2 GRADE B, COMPOSITION 1, 2 - 3 MILS		ONE COAT HAZE GRAY, MIL-PRF-24635, TYPE V, CLASS 2 GRADE B, COMPOSITION 2, 5 - 8 MILS --OR-- ONE COAT HAZE GRAY, MIL-PRF-24635, TYPE V, CLASS 2 GRADE B, COMPOSITION 1, 2 - 3 MILS
	7	NEAR WHITE METAL BLAST, NACE 2/SSPC-SP 10 - OR - WATERJETTING TO NACE/SSPC-SP WJ-2/M - OR - SSPC-SP 10/M (WAB)/NACE WAB-2/M	"SINGLE COAT"  ONE COAT MIL-PRF- 23236 TYPE VII CLASS 5/18 OR 7/18, 20 - 30 MILS  SEE NOTE (24)		ONE COAT MIL-PRF-23236, TYPE VII, CLASS 5/18 OR 7/18, 4 - 8 MILS --OR-- ONE COAT MIL-PRF-24635, TYPE V OR VI, CLASS 2, GRADE B OR C, COMPOSITION 2, 5 - 8 MILS --OR-- ONE COAT MIL-PRF-24635, TYPE V OR VI, CLASS 2, GRADE B OR C, COMPOSITION 1, 2 - 3 MILS  FOLLOWED BY INSULATION  SEE NOTES (64), & (86)	ONE COAT DECK GRAY, MIL- PRF-24635, TYPE V, CLASS 2 GRADE B, COMPOSITION 2, 5 - 8 MILS --OR-- ONE COAT DECK GRAY, MIL- PRF-24635, TYPE V, CLASS 2 GRADE B, COMPOSITION 1, 2 - 3 MILS		ONE COAT HAZE GRAY, MIL-PRF-24635, TYPE V, CLASS 2 GRADE B, COMPOSITION 2, 5 - 8 MILS --OR-- ONE COAT HAZE GRAY, MIL-PRF-24635, TYPE V, CLASS 2 GRADE B, COMPOSITION 1, 2 - 3 MILS



TABLE 2 STEEL SURFACES  SURFACE SHIPS	LINE	A SURFACE PREPARATION	B PRIMER	C	D	E HORIZONTAL SURFACES DECKS & FITTINGS	F MASTS & STACKS EXPOSED TO GASES	G VERTICAL SURFACES
	8	NEAR WHITE METAL BLAST, NACE 2/SSPC-SP 10 - OR - WATERJETTING TO NACE/SSPC-SP WJ-2/M - OR - SSPC-SP 10/M (WAB)/NACE WAB-2/M	ONE FULL COAT ANTICORROSIVE MIL- PRF-24647, TYPE I OR II, 5 - 7 MILS  SEE NOTE (8)	ONE STRIPE COAT ANTICORROSIVE MIL- PRF-24647, TYPE I OR II, 5 - 7 MILS  SEE NOTE (8)	ONE COAT ANTICORROSIVE MIL-PRF- 24647, 5 - 7 MILS --OR-- ONE COAT MIL-PRF-24635, TYPE V OR VI, CLASS 2, GRADE B OR C, COMPOSITION 2, 5 - 8 MILS  FOLLOWED BY INSULATION  SEE NOTES (8), (64), & (86)	ONE COAT HAZE GRAY, MIL- PRF-24635, TYPE V, CLASS 2 GRADE B, COMPOSITION 2, 5 - 8 MILS		ONE COAT HAZE GRAY, MIL-PRF-24635, TYPE V, CLASS 2, GRADE B, COMPOSITION 2, 5 - 8 MILS
	8A	NEAR WHITE METAL BLAST, NACE 2/SSPC-SP 10 - OR - WATERJETTING TO NACE/SSPC-SP WJ-2/M - OR - SSPC-SP 10/M (WAB)/NACE WAB-2/M	ONE FULL COAT ANTICORROSIVE MIL- PRF-24647, TYPE I OR II, 5 - 7 MILS  SEE NOTE (8)	ONE STRIPE COAT -- & -- ONE FULL COAT ANTICORROSIVE MIL- PRF-24647, TYPE I OR II, 5 - 7 MILS  SEE NOTE (8)	ONE COAT MIL-PRF-24635, TYPE V OR VI, CLASS 2, GRADE B OR C, COMPOSITION 1, 2 - 3 MILS  FOLLOWED BY INSULATION  SEE NOTES (8), (64), & (86)	ONE COAT HAZE GRAY, MIL- PRF-24635, TYPE V, CLASS 2 GRADE B, COMPOSITION 1, 2 - 3 MILS		ONE COAT HAZE GRAY, MIL-PRF-24635, TYPE V, CLASS 2, GRADE B, COMPOSITION 1, 2 - 3 MILS
HANGAR DECKS, FLIGHT DECKS & VERTICAL REPLENISHMENT DECK AREAS  MINIMUM 3 YEARS SERVICE LIFE  SEE NOTE (75)	9	NEAR WHITE METAL BLAST, NACE 2/SSPC-SP 10 - OR - WATERJETTING TO NACE/SSPC-SP WJ-2/L - OR - SSPC-SP 10/L(WAB)/NACE WAB- 2/L	ONE COAT PROPRIETARY NONSKID PRIMER LISTED ON THE QPL FOR MIL-PRF-24667 (OF TYPE TO MATCH COLUMN E)  SEE NOTE (7)	STRIPE COAT OF PROPRIETARY NONSKID PRIMER LISTED ON THE QPL FOR MIL-PRF-24667  SEE NOTE (7)		ONE COAT DARK GRAY, MIL- PRF-24667, TYPE V, COMP G  SEE NOTES (19), (22), (50), (56), (59), (61), & (63)		
HANGAR DECKS, FLIGHT DECKS & VERTICAL REPLENISHMENT DECK AREAS  MINIMUM 12 MONTHS SERVICE LIFE	10	NEAR WHITE METAL BLAST, NACE 2/SSPC-SP 10 - OR - WATERJETTING TO NACE/SSPC-SP WJ-2/L - OR - SSPC-SP 10/L(WAB)/NACE WAB- 2/L	ONE COAT PROPRIETARY NONSKID PRIMER LISTED ON THE QPL FOR MIL-PRF-24667 (OF TYPE TO MATCH COLUMN E)  SEE NOTE (7)	STRIPE COAT OF PROPRIETARY NONSKID PRIMER LISTED ON THE QPL FOR MIL-PRF-24667  SEE NOTE (7)		ONE COAT DARK GRAY, MIL- PRF-24667, TYPE VI, OR VIII, COMP G  SEE NOTES (19), (22), (50), (56), (59), (61), (63), & (72)		

TABLE 2 STEEL SURFACES  SURFACE SHIPS	LINE	A SURFACE PREPARATION	B PRIMER	C	D	E HORIZONTAL SURFACES DECKS & FITTINGS	F MASTS & STACKS EXPOSED TO GASES	G VERTICAL SURFACES
SEE NOTE (75)	11	NEAR WHITE METAL BLAST, NACE 2/SSPC-SP 10 - OR - WATERJETTING TO NACE/SSPC-SP WJ-2/L - OR - SSPC-SP 10/L(WAB)/NACE WAB- 2/L	ONE COAT PROPRIETARY NONSKID PRIMER LISTED ON THE QPL FOR MIL-PRF-24667 (OF TYPE TO MATCH COLUMN E)  SEE NOTE (7)	ONE FULL COAT OF PROPRIETARY NONSKID PRIMER LISTED ON THE QPL FOR MIL-PRF-24667  SEE NOTES (7) & (76)		ONE COAT DARK GRAY, MIL- PRF-24667, TYPE I, COMP G  SEE NOTES (19), (22), (50), (56), (59), (61), & (63)		
HANGAR DECKS, FLIGHT DECKS & VERTICAL REPLENISHMENT DECK AREAS  MINIMUM 6 MONTHS SERVICE LIFE  SEE NOTE (75)	12	NEAR WHITE METAL BLAST, NACE 2/SSPC-SP 10 - OR - WATERJETTING TO NACE/SSPC-SP WJ-2/L - OR - SSPC-SP 10/L(WAB)/NACE WAB- 2/L	ONE COAT PROPRIETARY NONSKID PRIMER LISTED ON THE QPL FOR MIL-PRF-24667 (OF TYPE TO MATCH COLUMN E)  SEE NOTE (7)	STRIPE COAT OF PROPRIETARY NONSKID PRIMER LISTED ON THE QPL FOR MIL-PRF-24667  SEE NOTE (7)		ONE COAT DARK GRAY, MIL- PRF-24667, TYPE II, COMP G  SEE NOTES (19), (22), (50), (56), (59), (61), & (63)		
HANGAR DECKS, FLIGHT DECKS, VERTICAL REPLENISHMENT DECK AREAS, CVN FLIGHT DECK LANDING AREAS, WALK AREAS AND ALL OTHER DECK AREAS  MINIMUM 30 DAYS SERVICE LIFE  SEE NOTE (75)	13	POWER TOOL CLEANING TO BARE METAL, SSPC-SP 11	ONE COAT PROPRIETARY NONSKID PRIMER LISTED ON THE QPL FOR MIL-PRF-24667 (OF TYPE TO MATCH COLUMN E)  SEE NOTE (7)	STRIPE COAT OF PROPRIETARY NONSKID PRIMER LISTED ON THE QPL FOR MIL-PRF-24667  SEE NOTE (7)		ONE COAT DARK GRAY, MIL-PRF-24667, TYPE VII, COMP G OR L  SEE NOTES (19), (22), (50), (56), (60), (61), & (63)		
	14	POWER TOOL CLEANING TO BARE METAL, SSPC-SP 11				ONE COAT DARK GRAY, MIL-PRF-24667, TYPE VII, COMP G OR L  SEE NOTES (19), (22), (50), (56), (60), (61), & (63)		
CVN FLIGHT DECK LANDING AREAS  SERVICE LIFE MINIMUM 15,000 LANDINGS	15	NEAR WHITE METAL BLAST, NACE 2/SSPC-SP 10 - OR - WATERJETTING TO NACE/SSPC-SP WJ-2/L - OR - SSPC-SP 10/L(WAB)/NACE WAB- 2/L	ONE COAT PROPRIETARY NONSKID PRIMER LISTED ON THE QPL FOR MIL-PRF-24667 (OF TYPE TO MATCH COLUMN E)  SEE NOTE (7)			ONE COAT DARK GRAY, MIL-PRF-24667, TYPE V, COMP L  SEE NOTES (19), (22), (50), (60), & (63)		

TABLE 2 STEEL SURFACES  SURFACE SHIPS	LINE	A SURFACE PREPARATION	B PRIMER	C	D	E HORIZONTAL SURFACES DECKS & FITTINGS	F MASTS & STACKS EXPOSED TO GASES	G VERTICAL SURFACES
CVN FLIGHT DECK LANDING AREAS  SERVICE LIFE MINIMUM 10,000 LANDINGS	16	NEAR WHITE METAL BLAST, NACE 2/SSPC-SP 10 - OR - WATERJETTING TO NACE/SSPC-SP WJ-2/L - OR - SSPC-SP 10/L(WAB)/NACE WAB- 2/L	ONE COAT PROPRIETARY NONSKID PRIMER LISTED ON THE QPL FOR MIL-PRF-24667 (OF TYPE TO MATCH COLUMN E)  SEE NOTE (7)			ONE COAT DARK GRAY, MIL-PRF-24667, TYPE I, VI, OR VIII COMP L  SEE NOTES (19), (22), (50), (60), (63), & (72)		
LHA, LHD, LPD, AND LSD FLIGHT DECK AREAS  MINIMUM 3 YEAR SERVICE LIFE	17	NEAR WHITE METAL BLAST, NACE 2/SSPC-SP 10 - OR - WATERJETTING TO NACE/SSPC-SP WJ-2/L - OR - SSPC-SP 10/L(WAB)/NACE WAB- 2/L  SEE NOTES (46) AND (49)	ONE COAT PROPRIETARY NONSKID PRIMER LISTED ON THE QPL FOR MIL-PRF-24667 (OF TYPE TO MATCH COLUMN E)  SEE NOTE (7)	STRIPE COAT OF PROPRIETARY NONSKID PRIMER LISTED ON THE QPL FOR MIL-PRF-24667  SEE NOTE (7)		ONE COAT DARK GRAY, MIL- PRF-24667, TYPE V, COMP D  SEE NOTES (19), (22), (50), & (63)		
LHA, LHD, LPD, AND LSD FLIGHT DECK AREAS  MINIMUM 12 MONTH SERVICE LIFE	18	NEAR WHITE METAL BLAST, NACE 2/SSPC-SP 10 - OR - WATERJETTING TO NACE/SSPC-SP WJ-2/L - OR - SSPC-SP 10/L(WAB)/NACE WAB- 2/L  SEE NOTES (46) AND (49)	ONE COAT PROPRIETARY NONSKID PRIMER LISTED ON THE QPL FOR MIL-PRF-24667 (OF TYPE TO MATCH COLUMN E)  SEE NOTE (7)	STRIPE COAT OF PROPRIETARY NONSKID PRIMER LISTED ON THE QPL FOR MIL-PRF-24667  SEE NOTE (7)		ONE COAT DARK GRAY, MIL- PRF-24667, TYPE I, COMP D  SEE NOTES (19), (22), (50), (63), & (72)		
	19	NEAR WHITE METAL BLAST, NACE 2/SSPC-SP 10 - OR - WATERJETTING TO NACE/SSPC-SP WJ-2/L - OR - SSPC-SP 10/L(WAB)/NACE WAB- 2/L  SEE NOTES (46) AND (49)	ONE COAT PROPRIETARY NONSKID PRIMER LISTED ON THE QPL FOR MIL-PRF-24667 (OF TYPE TO MATCH COLUMN E)  SEE NOTE (7)	ONE FULL COAT OF PROPRIETARY NONSKID PRIMER LISTED ON THE QPL FOR MIL-PRF-24667  SEE NOTES (7) & (76)		ONE COAT DARK GRAY, MIL- PRF-24667, TYPE I, COMP D  SEE NOTES (19), (22), (50), (63), & (72)		

TABLE 2 STEEL SURFACES  SURFACE SHIPS	LINE	A SURFACE PREPARATION	B PRIMER	C	D	E HORIZONTAL SURFACES DECKS & FITTINGS	F MASTS & STACKS EXPOSED TO GASES	G VERTICAL SURFACES
LHA, LHD, LPD, AND LSD FLIGHT DECK AREAS  MINIMUM 30 DAY SERVICE LIFE	20	NEAR WHITE METAL BLAST, NACE 2/SSPC-SP 10 - OR - WATERJETTING TO NACE/SSPC-SP WJ-2/L - OR - SSPC-SP 10/L(WAB)/NACE WAB-2/L  SEE NOTES (46) AND (49)	ONE COAT PROPRIETARY NONSKID PRIMER LISTED ON THE QPL FOR MIL-PRF-24667 (OF TYPE TO MATCH COLUMN E)  SEE NOTE (7)	STRIPE COAT OF PROPRIETARY NONSKID PRIMER LISTED ON THE QPL FOR MIL-PRF-24667  SEE NOTE (7)		ONE COAT DARK GRAY, MIL-PRF-24667, TYPE VII, COMP D  SEE NOTES (19), (22), (50), & (63)		
LHA, LHD, LPD, AND LSD VEHICLE RAMPS	20A	NEAR WHITE METAL BLAST, NACE 2/SSPC-SP 10 - OR - WATERJETTING TO NACE/SSPC-SP WJ-2/L - OR - SSPC-SP 10/L(WAB)/NACE WAB-2/L	ONE COAT PROPRIETARY NONSKID PRIMER LISTED ON THE QPL FOR MIL-PRF-24667 (OF TYPE TO MATCH COLUMN E)  SEE NOTE (7)	STRIPE COAT OF PROPRIETARY NONSKID PRIMER LISTED ON THE QPL FOR MIL-PRF-24667  SEE NOTE (7)		ONE COAT DARK GRAY, MIL-PRF-24667, TYPE I, COMP D  SEE NOTE (19), (22), (63) & (83)		
	20B	NEAR WHITE METAL BLAST, NACE 2/SSPC-SP 10 - OR - WATERJETTING TO NACE/SSPC-SP WJ-2/L - OR - SSPC-SP 10/L(WAB)/NACE WAB-2/L	ONE COAT PROPRIETARY NONSKID PRIMER LISTED ON THE QPL FOR MIL-PRF-24667 (OF TYPE TO MATCH COLUMN E)  SEE NOTE (7)	STRIPE COAT OF PROPRIETARY NONSKID PRIMER LISTED ON THE QPL FOR MIL-PRF-24667  SEE NOTE (7)		ONE COAT DARK GRAY, MIL-PRF-24667, TYPE V, COMP D  SEE NOTE (19), (22), (63) & (83)		

TABLE 2 STEEL SURFACES  SURFACE SHIPS	LINE	A SURFACE PREPARATION	B PRIMER	C	D	E HORIZONTAL SURFACES DECKS & FITTINGS	F MASTS & STACKS EXPOSED TO GASES	G VERTICAL SURFACES
EXTERIOR WALK AREAS AND INTERIOR SPACES INCLUDING MAGAZINES AND WEAPONS HANDLING AREAS (ALL DECK AREAS OTHER THAN HANGAR DECK, FLIGHT DECK, & VERTICAL REPLENISHMENT DECK AREAS)  SEE NOTE (75)	21	NEAR WHITE METAL BLAST, NACE 2/SSPC-SP 10 - OR - WATERJETTING TO NACE/SSPC-SP WJ-2/L - OR - SSPC-SP 10/L(WAB)/NACE WAB-2/L	ONE COAT PROPRIETARY NONSKID PRIMER LISTED ON THE QPL FOR MIL-PRF-24667 (OF TYPE TO MATCH COLUMN E)  SEE NOTE (7)	STRIPE COAT OF PROPRIETARY NONSKID PRIMER LISTED ON THE QPL FOR MIL-PRF-24667  SEE NOTE (7)		ONE COAT MIL-PRF-24667, TYPE I, V, VI, OR VIII, COMP G -OR- ONE COAT DARK GRAY, MIL-PRF-24667, TYPE II ROLLABLE, III ROLLABLE RESILIENT, IV SPRAYABLE, COMP G  SEE NOTES (19), (22), (59), & (63)		
	22	NEAR WHITE METAL BLAST, NACE 2/SSPC-SP 10 - OR - WATERJETTING TO NACE/SSPC-SP WJ-2/L - OR - SSPC-SP 10/L(WAB)/NACE WAB-2/L	ONE COAT PROPRIETARY NONSKID PRIMER LISTED ON THE QPL FOR MIL-PRF-24667 TYPE I, V, VI, OR VIII, COMP G, 4-6 MILS  SEE NOTE (7)	ONE STRIPE COAT PROPRIETARY NONSKID PRIMER LISTED ON THE QPL FOR MIL-PRF-24667 TYPE I, V, VI, OR VIII, COMP G, 4-6 MILS  SEE NOTE (7)		ONE COAT DECK GRAY MIL-PRF-24635 TYPE V, CLASS 2, GRADE B OR C, COMPOSITION 2, 5 - 8 MILS --OR-- ONE COAT DECK GRAY MIL-PRF-24635 TYPE V, CLASS 2, GRADE B OR C, COMPOSITION 1, 2 - 3 MILS --&-- APPLICATION OF MIL-PRF-24667, TYPE XI, COMP PS  SEE NOTES (19), (22),(63), (70) & (86)		
	23	NEAR WHITE METAL BLAST, NACE 2/SSPC-SP 10 - OR - WATERJETTING TO NACE/SSPC-SP WJ-2/L - OR - SSPC-SP 10/L(WAB)/NACE WAB-2/L	ONE COAT MIL-PRF-23236, TYPE V OR VI CLASS 5, 4-6 MILS	ONE STRIPE COAT MIL-PRF-23236, TYPE V OR VI CLASS 5, 4-6 MILS		ONE COAT DECK GRAY MIL-PRF-24635 TYPE V, CLASS 2, GRADE B OR C, COMPOSITION 2, 5 - 8 MILS --OR-- ONE COAT DECK GRAY MIL-PRF-24635 TYPE V, CLASS 2, GRADE B OR C, COMPOSITION 1, 2 - 3 MILS --&-- APPLICATION OF MIL-PRF-24667, TYPE XI, COMP PS  SEE NOTES (19), (22),(63), (70) & (86)		

TABLE 2 STEEL SURFACES  SURFACE SHIPS	LINE	A SURFACE PREPARATION	B PRIMER	C	D	E HORIZONTAL SURFACES DECKS & FITTINGS	F MASTS & STACKS EXPOSED TO GASES	G VERTICAL SURFACES
	24	NEAR WHITE METAL BLAST, NACE 2/SSPC-SP 10 - OR - WATERJETTING TO NACE/SSPC-SP WJ-2/L - OR - SSPC-SP 10/L(WAB)/NACE WAB- 2/L	ONE COAT MIL-PRF- 23236, TYPE VII CLASS 5, 15B, OR 17, 6-8 MILS			ONE COAT DECK GRAY MIL- PRF-24635 TYPE V, CLASS 2, GRADE B OR C, COMPOSITION 2, 5 - 8 MILS --OR-- ONE COAT DECK GRAY MIL- PRF-24635 TYPE V, CLASS 2, GRADE B OR C, COMPOSITION 1, 2 - 3 MILS --&-- APPLICATION OF MIL-PRF- 24667, TYPE XI, COMP PS  SEE NOTES (19), (22),(63), (70) & (86)		
	25	POWER TOOL CLEANING TO BARE METAL, SSPC-SP 11	ONE COAT MIL-PRF- 23236, TYPE V OR VI CLASS 5, 4-6 MILS	ONE STRIPE COAT MIL-PRF-23236, TYPE V OR VI CLASS 5, 4-6 MILS		ONE COAT DECK GRAY MIL- PRF-24635 TYPE V, CLASS 2, GRADE B OR C, COMPOSITION 2, 5 - 8 MILS --OR-- ONE COAT DECK GRAY MIL- PRF-24635 TYPE V, CLASS 2, GRADE B OR C, COMPOSITION 1, 2 - 3 MILS --&-- APPLICATION OF MIL-PRF- 24667, TYPE XI, COMP PS  SEE NOTES (19), (22),(63), (70) & (86)		
	26	POWER TOOL CLEANING TO BARE METAL, SSPC-SP 11	ONE COAT MIL-PRF- 23236, TYPE VII CLASS 15B OR 17, 6-8 MILS			ONE COAT DECK GRAY MIL- PRF-24635 TYPE V, CLASS 2, GRADE B OR C, COMPOSITION 2, 5 - 8 MILS --OR-- ONE COAT DECK GRAY MIL- PRF-24635 TYPE V, CLASS 2, GRADE B OR C, COMPOSITION 1, 2 - 3 MILS --&-- APPLICATION OF MIL-PRF- 24667, TYPE XI, COMP PS  SEE NOTES (19), (22),(63), (70) & (86)		

TABLE 2 STEEL SURFACES  SURFACE SHIPS	LINE	A SURFACE PREPARATION	B PRIMER	C	D	E HORIZONTAL SURFACES DECKS & FITTINGS	F MASTS & STACKS EXPOSED TO GASES	G VERTICAL SURFACES
RAST TRACK TROUGHS WHERE PAINTED (WHERE NONSKID NOT APPLIED)	27	NEAR WHITE METAL BLAST, NACE 2/SSPC-SP 10 - OR - WATERJETTING TO NACE/SSPC-SP WJ-2/L -OR- POWER TOOL CLEAN TO BARE METAL, SSPC-SP 11 - OR - SSPC-SP 10/L (WAB)/NACE WAB-2/L	ONE COAT MIL-PRF- 23236, TYPE VII, CLASS 17, 6 - 8 MILS --OR-- ONE COAT MIL-PRF- 23236, TYPE VII, CLASS 15B, 6 - 8 MILS		ONE COAT MIL-PRF-23236, TYPE VII, CLASS 17, 6 - 8 MILS --OR-- ONE COAT MIL-PRF-23236, TYPE VII, CLASS 15B, 6 - 8 MILS			
	28	NEAR WHITE METAL BLAST, NACE 2/SSPC-SP 10 - OR - WATERJETTING TO NACE/SSPC-SP WJ-2/M - OR - SSPC-SP 10/M (WAB)/NACE WAB-2/M	"SINGLE COAT"  ONE COAT MIL-PRF- 23236 TYPE VII CLASS 17/18, 20-30 MILS  SEE NOTE (24)					
	29	NEAR WHITE METAL BLAST, NACE 2/SSPC-SP 10 - OR - WATERJETTING TO NACE/SSPC-SP WJ-2/M - OR - SSPC-SP 10/M (WAB)/NACE WAB-2/M	ONE COAT MIL-PRF- 23236, TYPE VII, CLASS 5, 4-8 MILS		ONE COAT MIL-PRF-23236, TYPE VII, CLASS 5, 10-12 MILS			
CVN CATAPULT TROUGHS	30	NEAR WHITE METAL BLAST, NACE 2/SSPC-SP 10  SEE NOTE (30)	"SINGLE COAT"  ONE COAT MIL-PRF- 23236, TYPE VII, CLASS 19/18, 20-30 MILS					
WELL DECK OVERHEADS, BOTH EXPOSED & NON-EXPOSED TO LCAC EXHAUST, AND ENCLOSED BOAT HANDLING AREA OVERHEADS  SEE NOTE (34)	31	NEAR WHITE METAL BLAST, NACE 2/SSPC-SP 10  SEE NOTES (30) & (31)	ONE COAT MIL-PRF- 23236, TYPE VII, CLASS 19, 4 - 8 MILS		ONE COAT MIL-PRF-23236, TYPE VII, CLASS 19, 10 - 12 MILS			

TABLE 2 STEEL SURFACES  SURFACE SHIPS	LINE	A SURFACE PREPARATION	B PRIMER	C	D	E HORIZONTAL SURFACES DECKS & FITTINGS	F MASTS & STACKS EXPOSED TO GASES	G VERTICAL SURFACES
	32	NEAR WHITE METAL BLAST, NACE 2/SSPC-SP 10  SEE NOTES (30) & (31)	"SINGLE COAT"  ONE COAT MIL-PRF- 23236 TYPE VII CLASS 19/18, 20-30 MILS  SEE NOTE (24)					
	32A	THOROUGH SPOT AND SWEEP BLAST CLEANING, SSPC-SP 18  SEE NOTE (67)	"SINGLE COAT" ONE COAT MIL-PRF- 23236 TYPE VII CLASS 19/18, 20-60 MILS  SEE NOTE (24)					
WELL DECK AND ENCLOSED BOAT HANDLING AREA BULKHEADS AND DECKS	33	NEAR WHITE METAL BLAST, NACE 2/SSPC-SP 10  SEE NOTES (30) & (31)	"SINGLE COAT"  ONE COAT MIL-PRF- 23236 TYPE VII CLASS 7/18, 20-30 MILS  SEE NOTE (24)					
	33A	THOROUGH SPOT AND SWEEP BLAST CLEANING, SSPC-SP 18  SEE NOTE (67)	"SINGLE COAT" ONE COAT MIL-PRF- 23236 TYPE VII CLASS 19/18, 20-60 MILS  SEE NOTE (24)					



TABLE 2 STEEL SURFACES  SURFACE SHIPS	LINE	A SURFACE PREPARATION	B PRIMER	C	D	E HORIZONTAL SURFACES DECKS & FITTINGS	F MASTS & STACKS EXPOSED TO GASES	G VERTICAL SURFACES
EXTERIOR PORTABLE/BOLTED LOUVERS FOR INTAKES AND UPTAKES	34	NEAR WHITE METAL BLAST, NACE 2/SSPC-SP 10 - OR - WATERJETTING TO NACE/SSPC-SP WJ-2/M - OR - SSPC-SP 10/M (WAB)/NACE WAB-2/M	ONE COAT MIL-PRF- 23236, TYPE VII, CLASS 5 OR 7, 4 - 8 MILS		ONE COAT MIL-PRF-23236, TYPE VII, CLASS 5 OR 7, 10 - 12 MILS		ONE COAT HAZE GRAY MIL-PRF-24635 TYPE V OR VI, CLASS 2, GRADE B OR C, COMPOSITION 2, 5 - 8 MILS - OR - MIL-PRF-24763, TYPE II OR III, CLASS 2, GRADE B, 2 - 4 MILS --OR-- ONE COAT HAZE GRAY MIL-PRF-24635 TYPE V OR VI, CLASS 2, GRADE B OR C, COMPOSITION 1, 2 - 3 MILS  SEE NOTES (42), (64), (85), & (86)	ONE COAT HAZE GRAY MIL-PRF-24635 TYPE V OR VI, CLASS 2, GRADE B OR C, COMPOSITION 2, 5 - 8 MILS - OR - MIL-PRF-24763, TYPE II OR III, CLASS 2, GRADE B, 2 - 4 MILS --OR-- ONE COAT HAZE GRAY MIL-PRF-24635 TYPE V OR VI, CLASS 2, GRADE B OR C, COMPOSITION 1, 2 - 3 MILS  PAINT DESIGNATIONS & MARKINGS MIL-PRF- 24635 COMPOSITION 2, 5 - 8 MILS OR MIL- PRF-24635 COMPOSITION 1, 2 - 3 MILS  SEE NOTES (43), (47), (64), (85), & (86)

TABLE 2 STEEL SURFACES  SURFACE SHIPS	LINE	A SURFACE PREPARATION	B PRIMER	C	D	E HORIZONTAL SURFACES DECKS & FITTINGS	F MASTS & STACKS EXPOSED TO GASES	G VERTICAL SURFACES
	35	NEAR WHITE METAL BLAST, NACE 2/SSPC-SP 10 - OR - WATERJETTING TO NACE/SSPC-SP WJ-2/L - OR - SSPC-SP 10/L(WAB)/NACE WAB- 2/L	ONE COAT MIL-PRF- 23236, TYPE VII, CLASS 5 OR 7, 4 - 8 MILS		ONE COAT MIL-PRF-23236, TYPE VII, CLASS 5 OR 7, 10 - 12 MILS		ONE COAT HAZE GRAY MIL-PRF-24635 TYPE V OR VI, CLASS 2, GRADE B OR C, COMPOSITION 2, 5 - 8 MILS - OR - MIL-PRF-24763, TYPE II OR III, CLASS 2, GRADE B, 2 - 4 MILS --OR-- ONE COAT HAZE GRAY MIL-PRF-24635 TYPE V OR VI, CLASS 2, GRADE B OR C, COMPOSITION 1, 2 - 3 MILS  SEE NOTES (42), (64), (85), & (86)	ONE COAT HAZE GRAY MIL-PRF-24635 TYPE V OR VI, CLASS 2, GRADE B OR C, COMPOSITION 2, 5 - 8 MILS - OR - MIL-PRF-24763, TYPE II OR III, CLASS 2, GRADE B, 2 - 4 MILS --OR-- ONE COAT HAZE GRAY MIL-PRF-24635 TYPE V OR VI, CLASS 2, GRADE B OR C, COMPOSITION 1, 2 - 3 MILS  PAINT DESIGNATIONS & MARKINGS MIL-PRF- 24635 COMPOSITION 2, 5 - 8 MILS OR MIL- PRF-24635 COMPOSITION 1, 2 - 3 MILS  SEE NOTES (43), (47), (64), (85), & (86)
	36	NEAR WHITE METAL BLAST, NACE 2/SSPC-SP 10	ONE COAT MIL-PRF- 23236, TYPE VIIIA APPLIED BY FLUIDIZED BED METHOD ONLY, 10 MILS MINIMUM				ONE COAT MIL-PRF-24712, TGIC POLYESTER, TOTAL SYSTEM 15 - 30 MILS	ONE COAT MIL-PRF- 24712, TGIC POLYESTER, TOTAL SYSTEM 15 - 30 MILS

TABLE 2 STEEL SURFACES  SURFACE SHIPS	LINE	A SURFACE PREPARATION	B PRIMER	C	D	E HORIZONTAL SURFACES DECKS & FITTINGS	F MASTS & STACKS EXPOSED TO GASES	G VERTICAL SURFACES
	37	NEAR WHITE METAL BLAST, NACE 2/SSPC-SP 10 - OR - WATERJETTING TO NACE/SSPC-SP WJ-2/M - OR - SSPC-SP 10/M (WAB)/NACE WAB-2/M	"SINGLE COAT"  ONE COAT MIL-PRF- 23236, TYPE VII, CLASS 7/18, 20-30 MILS  SEE NOTE (24)				ONE COAT HAZE GRAY MIL-PRF-24635 TYPE V OR VI, CLASS 2, GRADE B OR C, COMPOSITION 2, 5 - 8 MILS - OR - MIL-PRF-24763, TYPE II OR III, CLASS 2, GRADE B, 2 - 4 MILS --OR-- ONE COAT HAZE GRAY MIL-PRF-24635 TYPE V OR VI, CLASS 2, GRADE B OR C, COMPOSITION 1, 2 - 3 MILS          SEE NOTES (42), (64), (85), & (86)	ONE COAT HAZE GRAY MIL-PRF-24635 TYPE V OR VI, CLASS 2, GRADE B OR C, COMPOSITION 2, 5 - 8 MILS - OR - MIL-PRF-24763, TYPE II OR III, CLASS 2, GRADE B, 2 - 4 MILS --OR-- ONE COAT HAZE GRAY MIL-PRF-24635 TYPE V OR VI, CLASS 2, GRADE B OR C, COMPOSITION 1, 2 - 3 MILS    PAINT DESIGNATIONS & MARKINGS MIL-PRF- 24635 COMPOSITION 2, 5 - 8 MILS OR MIL- PRF-24635 COMPOSITION 1, 2 - 3 MILS   SEE NOTES (43), (47), (64), (85), & (86)

TABLE 2 STEEL SURFACES SURFACE SHIPS	LINE	A SURFACE PREPARATION	B PRIMER	C	D	E HORIZONTAL SURFACES DECKS & FITTINGS	F MASTS & STACKS EXPOSED TO GASES	G VERTICAL SURFACES
	38	NEAR WHITE METAL BLAST, NACE 2/SSPC-SP 10 - OR - WATERJETTING TO NACE/SSPC-SP WJ-2/L - OR - SSPC-SP 10/L(WAB)/NACE WAB- 2/L	"SINGLE COAT"  ONE COAT MIL-PRF- 23236 TYPE VII CLASS 19/18, 20-30 MILS  SEE NOTE (24)				ONE COAT HAZE GRAY MIL-PRF-24635 TYPE V OR VI, CLASS 2, GRADE B OR C, COMPOSITION 2, 5 - 8 MILS - OR - MIL-PRF-24763, TYPE II OR III, CLASS 2, GRADE B, 2 - 4 MILS --OR-- ONE COAT HAZE GRAY MIL-PRF-24635 TYPE V OR VI, CLASS 2, GRADE B OR C, COMPOSITION 1, 2 - 3 MILS  SEE NOTES (42), (64), (85), & (86)	ONE COAT HAZE GRAY MIL-PRF-24635 TYPE V OR VI, CLASS 2, GRADE B OR C, COMPOSITION 2, 5 - 8 MILS - OR - MIL-PRF-24763, TYPE II OR III, CLASS 2, GRADE B, 2 - 4 MILS --OR-- ONE COAT HAZE GRAY MIL-PRF-24635 TYPE V OR VI, CLASS 2, GRADE B OR C, COMPOSITION 1, 2 - 3 MILS  PAINT DESIGNATIONS & MARKINGS MIL-PRF- 24635 COMPOSITION 2, 5 - 8 MILS OR MIL- PRF-24635 COMPOSITION 1, 2 -3 MILS  SEE NOTES (43), (47), (64), (85), & (86)
DDG GAS TURBINE BOLTED AIR INTAKE AND EXHAUST LOUVERS	39	NEAR WHITE METAL BLAST, NACE 2/SSPC-SP 10	ONE COAT MIL-PRF- 23236, TYPE VIII APPLIED BY FLUIDIZED BED METHOD ONLY, 10 MILS MINIMUM				ONE COAT MIL-PRF-24712, TGIC POLYESTER, TOTAL SYSTEM 15 - 30 MILS	ONE COAT MIL-PRF- 24712, TGIC POLYESTER, TOTAL SYSTEM 15 - 30 MILS

TABLE 2 STEEL SURFACES  SURFACE SHIPS	LINE	A SURFACE PREPARATION	B PRIMER	C	D	E HORIZONTAL SURFACES DECKS & FITTINGS	F MASTS & STACKS EXPOSED TO GASES	G VERTICAL SURFACES
	40	POWER TOOL CLEAN TO BARE METAL, SSPC-SP 11 FOR TOUCH-UP ONLY	ONE COAT MIL-PRF-23236, TYPE VII, CLASS 5 OR 7, 4 - 8 MILS		ONE COAT MIL-PRF-23236, TYPE VII, CLASS 5 OR 7, 10 - 12 MILS		ONE COAT HAZE GRAY MIL-PRF-24635 TYPE V OR VI, CLASS 2, GRADE B OR C, COMPOSITION 2, 5 - 8 MILS - OR - MIL-PRF-24763, TYPE II OR III, CLASS 2, GRADE B, 2 - 4 MILS --OR-- ONE COAT HAZE GRAY MIL-PRF-24635 TYPE V OR VI, CLASS 2, GRADE B OR C, COMPOSITION 1, 2 - 3 MILS  SEE NOTES (42), (64), (85), & (86)	ONE COAT HAZE GRAY MIL-PRF-24635 TYPE V OR VI, CLASS 2, GRADE B OR C, COMPOSITION 2, 5 - 8 MILS - OR - MIL-PRF-24763, TYPE II OR III, CLASS 2, GRADE B, 2 - 4 MILS --OR-- ONE COAT HAZE GRAY MIL-PRF-24635 TYPE V OR VI, CLASS 2, GRADE B OR C, COMPOSITION 1, 2 - 3 MILS  PAINT DESIGNATIONS & MARKINGS MIL-PRF-24635 COMPOSITION 2, 5 - 8 MILS OR MIL-PRF-24635 COMPOSITION 1, 2 - 3 MILS  SEE NOTES (43), (47), (64), (85), & (86)
POWDER COATED WATERTIGHT DOORS: INTERIOR AND EXTERIOR	41	NEAR WHITE METAL BLAST, NACE 2/SSPC-SP 10	ONE COAT MIL-PRF-23236, TYPE VIIIA APPLIED BY FLUIDIZED BED METHOD ONLY, 10 MILS MINIMUM				ONE COAT MIL-PRF-24712, TGIC POLYESTER, TOTAL SYSTEM 15 - 30 MILS	ONE COAT MIL-PRF-24712, TGIC POLYESTER, TOTAL SYSTEM 15 - 30 MILS
VERTICAL LAUNCH SYSTEM (VLS), MK-41	42	NEAR WHITE METAL BLAST, NACE 2/SSPC-SP 10, USING NEW, CLEAN, NON-RECYCLED, NON-FERROUS ALUMINUM OXIDE TYPE I, GRADE A OR GARNET, TYPE IV, GRADE A QUALIFIED TO A-A-59316  SEE NOTE (82)	ONE COAT PROPRIETARY NONSKID PRIMER LISTED ON THE QPL FOR MIL-PRF-24667 (OF TYPE TO MATCH COLUMN E)	ONE STRIPE COAT PROPRIETARY NONSKID PRIMER LISTED ON THE QPL FOR MIL-PRF-24667 (OF TYPE TO MATCH COLUMN E)	ONE FULL COAT PROPRIETARY NONSKID PRIMER LISTED ON THE QPL FOR MIL-PRF-24667 (OF TYPE TO MATCH COLUMN E)  SEE NOTE (16)	ONE COAT HAZE GRAY MIL-PRF-24667, TYPE I OR II, COMP G  SEE NOTE (19)		

TABLE 2 STEEL SURFACES  SURFACE SHIPS	LINE	A SURFACE PREPARATION	B PRIMER	C	D	E HORIZONTAL SURFACES DECKS & FITTINGS	F MASTS & STACKS EXPOSED TO GASES	G VERTICAL SURFACES
VLS, MK-41 (WHERE NONSKID IS NOT APPLIED)	43	NEAR WHITE METAL BLAST, NACE 2/SSPC-SP 10, USING NEW, CLEAN, NON-RECYCLED, NON- FERROUS ALUMINUM OXIDE TYPE I, GRADE A OR GARNET, TYPE IV, GRADE A QUALIFIED TO A-A-59316  SEE NOTE (82)	ONE COAT PROPRIETARY NONSKID PRIMER LISTED ON THE QPL FOR MIL-PRF-24667 (OF TYPE TO MATCH COLUMN E)	ONE STRIPE COAT PROPRIETARY NONSKID PRIMER LISTED ON THE QPL FOR MIL-PRF-24667 (OF TYPE TO MATCH COLUMN E)	ONE FULL COAT PROPRIETARY NONSKID PRIMER LISTED ON THE QPL FOR MIL-PRF-24667 (OF TYPE TO MATCH COLUMN E)  SEE NOTE (16)	ONE COAT HAZE GRAY MIL- PRF-24635, TYPE V OR VI, CLASS 2, GRADE B OR C, 2 COMPOSITION 2, 5 - 8 MILS-- OR— ONE COAT HAZE GRAY MIL- PRF-24635 TYPE V OR VI, CLASS 2, GRADE B OR C, COMPOSITION 1, 2 - 3 MILS  SEE NOTES (23), (70), & (85)		ONE COAT HAZE GRAY MIL-PRF-24635 TYPE V OR VI, CLASS 2, GRADE B OR C, COMPOSITION 2, 5 - 8 MILS  PAINT DESIGNATIONS & MARKINGS MIL-PRF- 24635 COMPOSITION 2, 5 - 8 MILS  SEE NOTES (43), (47), (64), (85), & (86)
EXTERIOR MIL-PRF-24667 (TYPES I - VIII) SURFACES  (GREEN CLEAN OF NONSKID DECK)	44	HIGH PRESSURE WATER CLEANING (HP WC) WITH VACUUM SELF- CONTAINED EQUIPMENT TO NACE/SSPC-SP WJ-4  SEE NOTE (80)						
PCMS (TILE REPAIR OR REINSTALLATION LESS THAN 15 SQUARE FEET)  SEE NOTES (45) & (74)	45	NEAR WHITE METAL BLAST, NACE 2/SSPC-SP 10 - OR - POWER TOOL CLEAN TO BARE METAL, SSPC-SP 11	ONE COAT MIL-PRF- 23236 TYPE V OR VI, CLASS 5 OR 7, 4 - 8 MILS	ONE STRIPE COAT MIL-PRF-23236 TYPE V OR VI, CLASS 5 OR 7, 4 - 8 MILS		ONE COAT MIL-PRF-23236 TYPE V OR VI, CLASS 5 OR 7, 4 - 8 MILS	ONE COAT MIL-PRF-23236 TYPE V OR VI, CLASS 5 OR 7, 4 - 8 MILS	ONE COAT MIL-PRF- 23236 TYPE V OR VI, CLASS 5 OR 7, 4 - 8 MILS
	46	NEAR WHITE METAL BLAST, NACE 2/SSPC-SP 10 - OR - POWER TOOL CLEAN TO BARE METAL, SSPC-SP 11	ONE COAT MIL-PRF- 23236 TYPE V OR VI, CLASS 5 OR 7, 4 - 8 MILS	ONE STRIPE COAT MIL-PRF-23236 TYPE V OR VI, CLASS 5 OR 7, 4 - 8 MILS	ONE COAT MIL-PRF-23236 TYPE V OR VI, CLASS 5 OR 7, 4 - 8 MILS	ONE COAT MIL-PRF-24635 TYPE V OR VI, CLASS 2, GRADE B OR C, COMPOSITION 2, 5 - 8 MILS  SEE NOTE (87)	ONE COAT MIL-PRF-24635 TYPE V OR VI, CLASS 2, GRADE B OR C, COMPOSITION 2, 5 - 8 MILS  SEE NOTE (87)	ONE COAT MIL-PRF- 24635 TYPE V OR VI, CLASS 2, GRADE B OR C, COMPOSITION 2, 5 - 8 MILS  SEE NOTE (87)

TABLE 2 STEEL SURFACES  SURFACE SHIPS	LINE	A SURFACE PREPARATION	B PRIMER	C	D	E HORIZONTAL SURFACES DECKS & FITTINGS	F MASTS & STACKS EXPOSED TO GASES	G VERTICAL SURFACES
	47	NEAR WHITE METAL BLAST, NACE 2/SSPC-SP 10 - OR - POWER TOOL CLEAN TO BARE METAL, SSPC-SP 11	ONE COAT MIL-PRF- 23236 TYPE VII, CLASS 5 OR 7, 10 - 12 MILS	ONE COAT MIL-PRF- 23236 TYPE VII, CLASS 5 OR 7, 10 - 12 MILS				
	48	NEAR WHITE METAL BLAST, NACE 2/SSPC-SP 10 - OR - POWER TOOL CLEAN TO BARE METAL, SSPC-SP 11	ONE COAT MIL-PRF- 23236 TYPE VII, CLASS 5 OR 7, 10 - 12 MILS	ONE COAT MIL-PRF- 23236 TYPE VII, CLASS 5 OR 7, 10 - 12 MILS		ONE COAT MIL-PRF-24635 TYPE V OR VI, CLASS 2, GRADE B OR C, COMPOSITION 2, 5 - 8 MILS	ONE COAT MIL-PRF-24635 TYPE V OR VI, CLASS 2, GRADE B OR C, COMPOSITION 2, 5 - 8 MILS	ONE COAT MIL-PRF- 24635 TYPE V OR VI, CLASS 2, GRADE B OR C, COMPOSITION 2, 5 - 8 MILS
PCMS (NEW TILE INSTALLATION AND REPAIR OR REINSTALLATION GREATER THAN 15 SQUARE FEET)	49	NEAR WHITE METAL BLAST, NACE 2/SSPC-SP 10  SEE NOTE (14) &(21)	ONE COAT MIL-PRF- 23236 TYPE VII, CLASS 5 OR 7, 10 - 12 MILS	ONE COAT MIL-PRF- 23236, TYPE VII, CLASS 5 OR 7, 10 - 12 MILS				
	50	NEAR WHITE METAL BLAST, NACE 2/SSPC-SP 10  SEE NOTE (14) &(21)	ONE COAT MIL-PRF- 23236 TYPE VII, CLASS 5 OR 7, 10 - 12 MILS	ONE COAT MIL-PRF- 23236, TYPE VII, CLASS 5 OR 7, 10 - 12 MILS		ONE COAT MIL-PRF-24635 TYPE V OR VI, CLASS 2, GRADE B OR C, COMPOSITION 2, 5 - 8 MILS  SEE NOTE (87)	ONE COAT MIL-PRF-24635 TYPE V OR VI, CLASS 2, GRADE B OR C, COMPOSITION 2, 5 - 8 MILS  SEE NOTE (87)	ONE COAT MIL-PRF- 24635 TYPE V OR VI, CLASS 2, GRADE B OR C, COMPOSITION 2, 5 - 8 MILS  SEE NOTE (87)
	51	NEAR WHITE METAL BLAST, NACE 2/SSPC-SP 10  SEE NOTE (14) &(21)	"SINGLE COAT"  ONE COAT MIL-PRF- 23236 TYPE VII CLASS 5/18 OR 7/18, 20-30 MILS  SEE NOTE (24)					

TABLE 2 STEEL SURFACES  SURFACE SHIPS	LINE	A SURFACE PREPARATION	B PRIMER	C	D	E HORIZONTAL SURFACES DECKS & FITTINGS	F MASTS & STACKS EXPOSED TO GASES	G VERTICAL SURFACES
	52	NEAR WHITE METAL BLAST, NACE 2/SSPC-SP 10  SEE NOTE (14) &(21)	"SINGLE COAT"  ONE COAT MIL-PRF- 23236 TYPE VII CLASS 5/18 OR 7/18, 20-30 MILS  SEE NOTE (24)			FULL COAT MIL-PRF-24635 TYPE V OR VI, CLASS 2, GRADE B OR C, COMPOSITION 2, 5 – 8 MILS  SEE NOTE (87)	FULL COAT MIL-PRF-24635 TYPE V OR VI, CLASS 2, GRADE B OR C, COMPOSITION 2, 5 – 8 MILS  SEE NOTE (87)	FULL COAT MIL-PRF- 24635 TYPE V OR VI, CLASS 2, GRADE B OR C, COMPOSITION 2, 5 – 8 MILS  SEE NOTE (87)



TABLE 2 ALUMINUM SURFACES  SURFACE SHIPS	LINE	A SURFACE PREPARATION	B PRIMER	C	D	E HORIZONTAL SURFACES DECKS & FITTINGS	F MASTS & STACKS EXPOSED TO GASES	G VERTICAL SURFACES
<p>EXTERIOR SURFACES ABOVE BOOTTOP, WITH EXCEPTION OF AREAS RECEIVING NONSKID, INCLUDES LCS 2 VARIANT AMAH TUNNELS</p> <p>SEE NOTES (2) &amp; (70)</p>	53	<p>THOROUGH ABRASIVE BLAST CLEANING OF NON-FERROUS METALS, SSPC-SP 17 USING MIL-A-22262 QUALIFIED MEDIA (EXCLUDING COAL SLAG), ALUMINUM OXIDE, OR STAINLESS STEEL MEDIA - OR - WATERJETTING TO NACE/SSPC-SP WJ-2</p> <p>SEE NOTES (90)</p>	<p>ONE STRIPE COAT MIL-PRF-23236, TYPE V OR VI, CLASS 5 OR 7, 4 - 8 MILS -- OR -- ONE STRIPE COAT MIL-PRF-23236, TYPE VII, CLASS 5 OR 7, 6 - 10 MILS --OR-- ONE STRIPE COAT MIL-PRF-23236, TYPE VII, CLASS 5/18 OR 7/18, 10 - 15 MILS --OR-- ONE STRIPE COAT MIL-PRF-24635, TYPE V OR VI, CLASS 2, GRADE B OR C, COMPOSITION 2, 5 - 8 MILS</p> <p>SEE NOTE (86)</p>			<p>ONE COAT DECK GRAY MIL-PRF-24635, TYPE V OR VI, CLASS 2, GRADE B OR C, COMPOSITION 2, 5 - 8 MILS</p> <p>SEE NOTE (86)</p>	<p>ONE COAT HAZE GRAY MIL-PRF-24635, TYPE V OR VI, CLASS 2, GRADE B OR C, COMPOSITION 2, 5 - 8 MILS</p> <p>SEE NOTE (86)</p>	<p>ONE COAT HAZE GRAY MIL-PRF-24635, TYPE V OR VI, CLASS 2, GRADE B OR C, COMPOSITION 2, 5 - 8 MILS</p> <p>IDENTIFICATION MARKINGS: PAINT DESIGNATIONS &amp; MARKINGS MIL-PRF-24635, COMPOSITION 2, 5 - 8 MILS</p> <p>SEE NOTE (86)</p>
<p>EXTERIOR SURFACES ABOVE BOOTTOP, WITH EXCEPTION OF AREAS RECEIVING NONSKID, INCLUDES LCS 2 VARIANT AMAH TUNNELS</p> <p>SEE NOTES (2) &amp; (70)</p>	54	<p>THOROUGH ABRASIVE BLAST CLEANING OF NON-FERROUS METALS, SSPC-SP 17 USING MIL-A-22262 QUALIFIED MEDIA (EXCLUDING COAL SLAG), ALUMINUM OXIDE, OR STAINLESS STEEL MEDIA - OR - WATERJETTING TO NACE/SSPC-SP WJ-2</p> <p>SEE NOTES (90)</p>	<p>ONE FULL COAT MIL-PRF-23236, TYPE V OR VI, CLASS 5 OR 7, 4 - 8 MILS -- OR -- ONE FULL COAT MIL-PRF-23236, TYPE VII, CLASS 5 OR 7, 6 - 10 MILS --OR-- ONE FULL COAT MIL-PRF-23236, TYPE VII, CLASS 5/18 OR 7/18, 10 - 15 MILS</p> <p>SEE NOTE (86)</p>	<p>ONE STRIPE COAT MIL-PRF-23236, TYPE V OR VI, CLASS 5 OR 7, 4 - 8 MILS -- OR -- ONE STRIPE COAT MIL-PRF-23236, TYPE VII, CLASS 5 OR 7, 6 - 10 MILS --OR-- ONE STRIPE COAT MIL-PRF-23236, TYPE VII, CLASS 5/18 OR 7/18, 10 - 15 MILS</p> <p>SEE NOTE (86)</p>		<p>ONE COAT DECK GRAY MIL-PRF-24635, TYPE V OR VI, CLASS 2, GRADE B OR C, COMPOSITION 1, 2 - 3 MILS</p> <p>SEE NOTE (86)</p>	<p>ONE COAT HAZE GRAY MIL-PRF-24635, TYPE V OR VI, CLASS 2, GRADE B OR C, COMPOSITION 1, 2 - 3 MILS</p> <p>SEE NOTE (86)</p>	<p>ONE COAT HAZE GRAY MIL-PRF-24635, TYPE V OR VI, CLASS 2, GRADE B OR C, COMPOSITION 1, 2 - 3 MILS</p> <p>IDENTIFICATION MARKINGS: PAINT DESIGNATIONS &amp; MARKINGS MIL-PRF-24635, COMPOSITION 2, 5 - 8 MILS</p> <p>SEE NOTE (86)</p>

TABLE 2 ALUMINUM SURFACES  SURFACE SHIPS	LINE	A SURFACE PREPARATION	B PRIMER	C	D	E HORIZONTAL SURFACES DECKS & FITTINGS	F MASTS & STACKS EXPOSED TO GASES	G VERTICAL SURFACES
<p>HANGAR DECKS, FLIGHT DECKS, AIRCRAFT ELEVATOR PLATFORM DECKS &amp; VERTICAL REPLENISHMENT DECK AREAS MINIMUM 3 YEARS SERVICE LIFE</p> <p>SEE NOTE (75) &amp; (92)</p>	55	<p>THOROUGH ABRASIVE BLAST CLEANING OF NON-FERROUS METALS, SSPC-SP 17 USING MIL- A-22262 QUALIFIED MEDIA (EXCLUDING COAL SLAG), ALUMINUM OXIDE, OR STAINLESS STEEL MEDIA - OR - WATERJETTING TO NACE/SSPC-SP WJ-2</p> <p>SEE NOTES (90)&amp; (91)</p>	<p>ONE COAT PROPRIETARY NONSKID PRIMER LISTED ON THE QPL FOR MIL-PRF-24667 (OF TYPE TO MATCH COLUMN E) WILL BE APPLIED WITHIN 6 HOURS AFTER SURFACE PREPARATION</p> <p>SEE NOTES (5) &amp; (7)</p>			<p>ONE COAT DARK GRAY, MIL- PRF-24667, TYPE V, COMP G</p> <p>SEE NOTES (19), (22), (50), (56), (59), (61), &amp; (63)</p>		
<p>HANGAR DECKS, FLIGHT DECKS, AIRCRAFT ELEVATOR PLATFORM DECKS &amp; VERTICAL REPLENISHMENT DECK AREAS MINIMUM 12 MONTHS SERVICE LIFE SEE NOTE (75) &amp; (92)</p>	56	<p>THOROUGH ABRASIVE BLAST CLEANING OF NON-FERROUS METALS, SSPC-SP 17 USING MIL- A-22262 QUALIFIED MEDIA (EXCLUDING COAL SLAG), ALUMINUM OXIDE, OR STAINLESS STEEL MEDIA - OR - WATERJETTING TO NACE/SSPC-SP WJ-2</p> <p>SEE NOTES (90) &amp; (91)</p>	<p>ONE COAT PROPRIETARY NONSKID PRIMER LISTED ON THE QPL FOR MIL-PRF-24667 (OF TYPE TO MATCH COLUMN E) WILL BE APPLIED WITHIN 6 HOURS AFTER SURFACE PREPARATION</p> <p>SEE NOTES (5) &amp; (7)</p>			<p>ONE COAT DARK GRAY MIL- PRF-24667, TYPE I, VI, OR VIII, COMP G</p> <p>SEE NOTES (19), (22), (50), (56), (59), (61), (63), &amp; (72)</p>		

TABLE 2 ALUMINUM SURFACES  SURFACE SHIPS	LINE	A SURFACE PREPARATION	B PRIMER	C	D	E HORIZONTAL SURFACES DECKS & FITTINGS	F MASTS & STACKS EXPOSED TO GASES	G VERTICAL SURFACES
HANGAR DECKS, FLIGHT DECKS, AIRCRAFT ELEVATOR PLATFORM DECKS & VERTICAL REPLENISHMENT DECK AREAS MINIMUM 6 MONTHS SERVICE LIFE  SEE NOTE (75) & (92)	57	THOROUGH ABRASIVE BLAST CLEANING OF NON-FERROUS METALS, SSPC-SP 17 USING MIL- A-22262 QUALIFIED MEDIA (EXCLUDING COAL SLAG), ALUMINUM OXIDE, OR STAINLESS STEEL MEDIA - OR - WATERJETTING TO NACE/SSPC-SP WJ-2  SEE NOTES (90) & (91)	ONE COAT PROPRIETARY NONSKID PRIMER LISTED ON THE QPL FOR MIL-PRF-24667 (OF TYPE TO MATCH COLUMN E) WILL BE APPLIED WITHIN 6 HOURS AFTER SURFACE PREPARATION  SEE NOTES (5) & (7)			ONE COAT DARK GRAY MIL- PRF-24667 TYPE II, COMP G  SEE NOTES (19), (22), (50), (56), (59), (61), & (63)		
HANGAR DECKS, FLIGHT DECKS, AIRCRAFT ELEVATOR PLATFORM DECKS, VERTICAL REPLENISHMENT DECK AREAS, CVN FLIGHT DECK LANDING AREAS, WALK AREAS AND ALL OTHER DECK AREAS MINIMUM 30 DAYS SERVICE LIFE  SEE NOTE (75)	58	POWER TOOL CLEAN TO BARE METAL, SSPC- SP 11  SEE NOTE (89)	ONE COAT PROPRIETARY NONSKID PRIMER LISTED ON THE QPL FOR MIL-PRF-24667 (OF TYPE TO MATCH COLUMN E) WILL BE APPLIED WITHIN 6 HOURS AFTER SURFACE PREPARATION  SEE NOTES (5) & (7)			ONE COAT DARK GRAY, MIL-PRF-24667, TYPE VII, COMP G OR L  SEE NOTES (19), (22), (50), (56), (60), (61), & (63)		
	59	POWER TOOL CLEAN TO BARE METAL, SSPC- SP 11  SEE NOTE (89)				ONE COAT DARK GRAY, MIL-PRF-24667, TYPE VII, COMP G OR L  SEE NOTES (19), (22), (50), (56), (60), (61), & (63)		

TABLE 2 ALUMINUM SURFACES  SURFACE SHIPS	LINE	A SURFACE PREPARATION	B PRIMER	C	D	E HORIZONTAL SURFACES DECKS & FITTINGS	F MASTS & STACKS EXPOSED TO GASES	G VERTICAL SURFACES
<p>EXTERIOR WALK AREAS AND INTERIOR SPACES INCLUDING MAGAZINES AND WEAPONS HANDLING AREAS (ALL DECK AREAS OTHER THAN HANGAR DECK, FLIGHT DECK, &amp; VERTICAL REPLENISHMENT DECK AREAS)</p> <p>SEE NOTE (75)</p>	60	<p>THOROUGH ABRASIVE BLAST CLEANING OF NON-FERROUS METALS, SSPC-SP 17 USING MIL-A-22262 QUALIFIED MEDIA (EXCLUDING COAL SLAG), ALUMINUM OXIDE, OR STAINLESS STEEL MEDIA - OR - WATERJETTING TO NACE/SSPC-SP WJ-2</p> <p>SEE NOTES (90)</p>	<p>ONE COAT PROPRIETARY NONSKID PRIMER LISTED ON THE QPL FOR MIL-PRF-24667 (OF TYPE TO MATCH COLUMN E) WILL BE APPLIED WITHIN 6 HOURS AFTER SURFACE PREPARATION</p> <p>SEE NOTES (5) &amp; (7)</p>			<p>ONE COAT MIL-PRF-24667, TYPE I, V, VI, OR VIII, COMP G</p> <p>-OR-</p> <p>ONE COAT DARK GRAY, MIL-PRF-24667, TYPE II ROLLABLE, III ROLLABLE RESILIENT, IV SPRAYABLE, COMP G</p> <p>SEE NOTES (19), (22), (59), &amp;(63)</p>		

TABLE 2 ALUMINUM SURFACES SURFACE SHIPS	LINE	A SURFACE PREPARATION	B PRIMER	C	D	E HORIZONTAL SURFACES DECKS & FITTINGS	F MASTS & STACKS EXPOSED TO GASES	G VERTICAL SURFACES
	61	<p>THOROUGH ABRASIVE BLAST CLEANING OF NON-FERROUS METALS, SSPC-SP 17 USING MIL-A-22262 QUALIFIED MEDIA (EXCLUDING COAL SLAG), ALUMINUM OXIDE, OR STAINLESS STEEL MEDIA - OR - WATERJETTING TO NACE/SSPC-SP WJ-2</p> <p>SEE NOTES (90)</p>	<p>ONE FULL COAT PROPRIETARY NONSKID PRIMER LISTED ON THE QPL FOR MIL-PRF-24667 TYPE I, V, VI OR VIII COMP G, 4-6 MILS</p> <p>SEE NOTE (7)</p>			<p>ONE COAT DECK GRAY MIL-PRF-24635, TYPE V OR VI, CLASS 2, GRADE B OR C, COMPOSITION 2, 5 - 8 MILS --OR--</p> <p>ONE COAT DECK GRAY MIL-PRF-24635, TYPE V OR VI, CLASS 2, GRADE B OR C, COMPOSITION 1, 2 -3 MILS -- &amp; --</p> <p>APPLICATION OF MIL-PRF-24667, TYPE XI, COMP PS</p> <p>SEE NOTES (19), (22), (63) &amp; (86)</p>		

TABLE 2 ALUMINUM SURFACES SURFACE SHIPS	LINE	A SURFACE PREPARATION	B PRIMER	C	D	E HORIZONTAL SURFACES DECKS & FITTINGS	F MASTS & STACKS EXPOSED TO GASES	G VERTICAL SURFACES
	62	THOROUGH ABRASIVE BLAST CLEANING OF NON-FERROUS METALS, SSPC-SP 17 USING MIL- A-22262 QUALIFIED MEDIA (EXCLUDING COAL SLAG), ALUMINUM OXIDE, OR STAINLESS STEEL MEDIA - OR - WATERJETTING TO NACE/SSPC-SP WJ-2  SEE NOTES (90)	ONE COAT MIL-PRF- 23236, TYPE V, VI, OR VII CLASS 5, 15B, OR 17, 4-6 MILS			ONE COAT DECK GRAY MIL- PRF-24635, TYPE V OR VI, CLASS 2, GRADE B OR C, COMPOSITION 2, 5 - 8 MILS --OR-- ONE COAT DECK GRAY MIL- PRF-24635, TYPE V OR VI, CLASS 2, GRADE B OR C, COMPOSITION 1, 2 -3 MILS -- & -- APPLICATION OF MIL-PRF- 24667, TYPE XI, COMP PS  SEE NOTES (19), (22), (63) & (86)		

TABLE 2 ALUMINUM SURFACES SURFACE SHIPS	LINE	A SURFACE PREPARATION	B PRIMER	C	D	E HORIZONTAL SURFACES DECK & FITTINGS	F MASTS & STACKS EXPOSED TO GASES	G VERTICAL SURFACES
	63	POWER TOOL CLEAN TO BARE METAL, SSPC-SP 11  SEE NOTE (5) & (89)	ONE COAT MIL-PRF-23236, TYPE V, VI, OR VII CLASS 15B OR 17, 6 - 8 MILS			ONE COAT DECK GRAY MIL-PRF-24635, TYPE V OR VI, CLASS 2, GRADE B OR C, COMPOSITION 2, 5 - 8 MILS --OR-- ONE COAT DECK GRAY MIL-PRF-24635, TYPE V OR VI, CLASS 2, GRADE B OR C, COMPOSITION 1, 2 -3 MILS -- & -- APPLICATION OF MIL-PRF-24667, TYPE XI, COMP PS  SEE NOTES (19), (22), (63) & (86)		
RAST TRACK TROUGHS WHERE PAINTED (WHERE NONSKID NOT APPLIED)	64	THOROUGH ABRASIVE BLAST CLEANING OF NON-FERROUS METALS, SSPC-SP 17 USING MIL-A-22262 QUALIFIED MEDIA (EXCLUDING COAL SLAG) OR ALUMINUM OXIDE - OR - - WATERJETTING TO NACE/SSPC-SP WJ-2/L -OR- POWER TOOL CLEAN TO BARE METAL, SSPC-SP 11  SEE NOTES (89), & (90)	ONE COAT MIL-PRF-23236, TYPE VII, CLASS 15B OR 17, 6 - 8 MILS		ONE COAT MIL-PRF-23236, TYPE VII, CLASS 15B OR 17, 6 - 8 MILS			

TABLE 2 ALUMINUM SURFACES SURFACE SHIPS	LINE	A SURFACE PREPARATION	B PRIMER	C	D	E HORIZONTAL SURFACES DECKS & FITTINGS	F MASTS & STACKS EXPOSED TO GASES	G VERTICAL SURFACES
	65	THOROUGH ABRASIVE BLAST CLEANING OF NON-FERROUS METALS, SSPC-SP 17 USING MIL- A-22262 QUALIFIED MEDIA (EXCLUDING COAL SLAG), ALUMINUM OXIDE, OR STAINLESS STEEL MEDIA - OR - WATERJETTING TO NACE/SSPC-SP WJ-2  SEE NOTES (90)	"SINGLE COAT"  ONE COAT MIL-PRF- 23236 TYPE VII CLASS 17/18, 20-30 MILS  SEE NOTE (24)					
	66	THOROUGH ABRASIVE BLAST CLEANING OF NON-FERROUS METALS, SSPC-SP 17 USING MIL- A-22262 QUALIFIED MEDIA (EXCLUDING COAL SLAG), ALUMINUM OXIDE, OR STAINLESS STEEL MEDIA - OR - WATERJETTING TO NACE/SSPC-SP WJ-2  SEE NOTES (90)	ONE COAT MIL-PRF- 23236, TYPE VII, CLASS 5, 4-8 MILS		ONE COAT MIL-PRF-23236, TYPE VII, CLASS 5, 10-12 MILS			



TABLE 2 ALUMINUM SURFACES  SURFACE SHIPS	LINE	A SURFACE PREPARATION	B PRIMER	C	D	E HORIZONTAL SURFACES DECKS & FITTINGS	F MASTS & STACKS EXPOSED TO GASES	G VERTICAL SURFACES
EXTERIOR PORTABLE/BOLTED LOUVERS FOR INTAKES AND UPTAKES	67	THOROUGH ABRASIVE BLAST CLEANING OF NON-FERROUS METALS, SSPC-SP 17 USING MIL- A-22262 QUALIFIED MEDIA (EXCLUDING COAL SLAG), ALUMINUM OXIDE, OR STAINLESS STEEL MEDIA - OR - WATERJETTING TO NACE/SSPC-SP WJ-2  SEE NOTES (90)	ONE COAT MIL-PRF-23236, TYPE VII, CLASS 5 OR 7, 4 - 8 MILS		ONE COAT MIL-PRF-23236, TYPE VII, CLASS 5 OR 7, 10 - 12 MILS		ONE COAT HAZE GRAY MIL-PRF-24635, TYPE V OR VI, CLASS 2, GRADE B OR C, COMPOSITION 2, 5 - 8 MILS  SEE NOTE (86)	ONE COAT HAZE GRAY MIL-PRF-24635, TYPE V OR VI, CLASS 2, GRADE B OR C, COMPOSITION 2, 5 - 8 MILS  IDENTIFICATION MARKINGS: PAINT DESIGNATIONS & MARKINGS MIL- PRF-24635, COMPOSITION 2, 5 - 8 MILS  SEE NOTE (86)
	68	THOROUGH ABRASIVE BLAST CLEANING OF NON-FERROUS METALS, SSPC-SP 17 USING MIL- A-22262 QUALIFIED MEDIA (EXCLUDING COAL SLAG), ALUMINUM OXIDE, OR STAINLESS STEEL MEDIA - OR - WATERJETTING TO NACE/SSPC-SP WJ-2  SEE NOTES (90)	ONE COAT MIL-PRF-23236, TYPE VII, CLASS 5 OR 7, 4 - 8 MILS		ONE COAT MIL-PRF-23236, TYPE VII, CLASS 5 OR 7, 10 - 12 MILS		ONE COAT HAZE GRAY MIL-PRF-24635, TYPE V OR VI, CLASS 2, GRADE B OR C, COMPOSITION 2, 5 - 8 MILS  SEE NOTE (86)	ONE COAT HAZE GRAY MIL-PRF-24635, TYPE V OR VI, CLASS 2, GRADE B OR C, COMPOSITION 2, 5 - 8 MILS  IDENTIFICATION MARKINGS: PAINT DESIGNATIONS & MARKINGS MIL- PRF-24635, COMPOSITION 2, 5 - 8 MILS  SEE NOTE (86)

TABLE 2 ALUMINUM SURFACES SURFACE SHIPS	LINE	A SURFACE PREPARATION	B PRIMER	C	D	E HORIZONTAL SURFACES DECKS & FITTINGS	F MASTS & STACKS EXPOSED TO GASES	G VERTICAL SURFACES
	69	POWER TOOL CLEAN TO BARE METAL, SSPC-SP 11  SEE NOTE (89)	ONE COAT MIL-PRF-23236, TYPE VIIIA APPLIED BY FLUIDIZED BED METHOD ONLY, 10 MILS MINIMUM				ONE COAT MIL-PRF-24712, TGIC POLYESTER, TOTAL SYSTEM 15 - 30 MILS	ONE COAT MIL-PRF-24712, TGIC POLYESTER, TOTAL SYSTEM 15 - 30 MILS
	70	THOROUGH ABRASIVE BLAST CLEANING OF NON-FERROUS METALS, SSPC-SP 17 USING MIL-A-22262 QUALIFIED MEDIA (EXCLUDING COAL SLAG), ALUMINUM OXIDE, OR STAINLESS STEEL MEDIA - OR - WATERJETTING TO NACE/SSPC-SP WJ-2  SEE NOTES (90)	"SINGLE COAT"  ONE COAT MIL-PRF-23236, TYPE VII, CLASS 7/18, 20-30 MILS  SEE NOTE (24)				ONE COAT HAZE GRAY MIL-PRF-24635, TYPE V OR VI, CLASS 2, GRADE B OR C, COMPOSITION 2, 5 - 8 MILS  SEE NOTE (86)	ONE COAT HAZE GRAY MIL-PRF-24635, TYPE V OR VI, CLASS 2, GRADE B OR C, COMPOSITION 2, 5 - 8 MILS  IDENTIFICATION MARKINGS: PAINT DESIGNATIONS & MARKINGS MIL-PRF-24635, COMPOSITION 2, 5 - 8 MILS  SEE NOTE (86)



TABLE 2 ALUMINUM SURFACES  SURFACE SHIPS	LINE	A SURFACE PREPARATION	B PRIMER	C	D	E HORIZONTAL SURFACES DECKS & FITTINGS	F MASTS & STACKS EXPOSED TO GASES	G VERTICAL SURFACES
VLS, MK-41 (WHERE NONSKID IS NOT APPLIED)	73	THOROUGH ABRASIVE BLAST CLEANING OF NON-FERROUS METALS, SSPC-SP 17 USING MIL- A-22262 QUALIFIED MEDIA (EXCLUDING COAL SLAG), ALUMINUM OXIDE, OR STAINLESS STEEL MEDIA - OR - WATERJETTING TO NACE/SSPC-SP WJ-2  SEE NOTES (90)	ONE COAT PROPRIETARY NONSKID PRIMER LISTED ON THE QPL FOR MIL-PRF-24667 (OF TYPE TO MATCH COLUMN E) WILL BE APPLIED WITHIN 6 HOURS AFTER SURFACE PREPARATION  SEE NOTES (5) & (7)			ONE COAT HAZE GRAY MIL- PRF-24635, TYPE V OR VI, CLASS 2, GRADE B OR C, COMPOSITION 2, 5 - 8 MILS --OR-- ONE COAT HAZE GRAY MIL- PRF-24635, TYPE V OR VI, CLASS 2, GRADE B OR C, COMPOSITION 1, 2 - 3 MILS  SEE NOTES (23), (70) & (85)		ONE COAT HAZE GRAY MIL-PRF-24635 TYPE V OR VI, CLASS 2, GRADE B OR C, COMPOSITION 2, 5 - 8 MILS  PAINT DESIGNATIONS & MARKINGS MIL- PRF-24635 COMPOSITION 2, 5 - 8 MILS  SEE NOTES (43), (47), (64), (85), & (86)
EXTERIOR MIL-PRF-24667 (TYPES I - VIII) SURFACES  (GREEN CLEAN OF NONSKID DECKS INCLUDING FLIGHT DECK)	74	HIGH PRESSURE WATER CLEANING (HP WC) WITH VACUUM SELF- CONTAINED EQUIPMENT TO NACE/SSPC-SP WJ-4  SEE NOTE (80)						
PCMS (TILE REPAIR OR REINSTALLATION LESS THAN 15 SQUARE FEET)  SEE NOTES (45) & (74)	75	THOROUGH ABRASIVE BLAST CLEANING OF NON-FERROUS METALS, SSPC-SP 17 USING MIL- A-22262 QUALIFIED MEDIA (EXCLUDING COAL SLAG) OR ALUMINUM OXIDE, - OR - POWER TOOL CLEAN TO BARE METAL, SSPC- SP 11	ONE COAT MIL-PRF- 23236 TYPE V OR VI, CLASS 5 OR 7, 4 - 8 MILS	ONE STRIPE COAT MIL-PRF-23236 TYPE V OR VI, CLASS 5 OR 7, 4 - 8 MILS		ONE COAT MIL-PRF-23236 TYPE V OR VI, CLASS 5 OR 7, 4 - 8 MILS	ONE COAT MIL-PRF-23236 TYPE V OR VI, CLASS 5 OR 7, 4 - 8 MILS	ONE COAT MIL-PRF- 23236 TYPE V OR VI, CLASS 5 OR 7, 4 - 8 MILS

TABLE 2 ALUMINUM SURFACES  SURFACE SHIPS	LINE	A SURFACE PREPARATION	B PRIMER	C	D	E HORIZONTAL SURFACES DECKS & FITTINGS	F MASTS & STACKS EXPOSED TO GASES	G VERTICAL SURFACES
	76	THOROUGH ABRASIVE BLAST CLEANING OF NON-FERROUS METALS, SSPC-SP 17 USING MIL-A-22262 QUALIFIED MEDIA (EXCLUDING COAL SLAG) OR ALUMINUM OXIDE, - OR - POWER TOOL CLEAN TO BARE METAL, SSPC-SP 11	ONE COAT MIL-PRF-23236 TYPE V OR VI, CLASS 5 OR 7, 4 - 8 MILS	ONE STRIPE COAT MIL-PRF-23236 TYPE V OR VI, CLASS 5 OR 7, 4 - 8 MILS	ONE COAT MIL-PRF-23236 TYPE V OR VI, CLASS 5 OR 7, 4 - 8 MILS	ONE COAT MIL-PRF-24635 TYPE V OR VI, CLASS 2, GRADE B OR C, COMPOSITION 2, 5 - 8 MILS  SEE NOTE (87)	ONE COAT MIL-PRF-24635 TYPE V OR VI, CLASS 2, GRADE B OR C, COMPOSITION 2, 5 - 8 MILS  SEE NOTE (87)	ONE COAT MIL-PRF-24635 TYPE V OR VI, CLASS 2, GRADE B OR C, COMPOSITION 2, 5 - 8 MILS  SEE NOTE (87)
	77	THOROUGH ABRASIVE BLAST CLEANING OF NON-FERROUS METALS, SSPC-SP 17 USING MIL-A-22262 QUALIFIED MEDIA (EXCLUDING COAL SLAG) OR ALUMINUM OXIDE, - OR - POWER TOOL CLEAN TO BARE METAL, SSPC-SP 11	ONE COAT MIL-PRF-23236 TYPE VII, CLASS 5 OR 7, 10 - 12 MILS	ONE COAT MIL-PRF-23236 TYPE VII, CLASS 5 OR 7, 10 - 12 MILS				
	78	THOROUGH ABRASIVE BLAST CLEANING OF NON-FERROUS METALS, SSPC-SP 17 USING MIL-A-22262 QUALIFIED MEDIA (EXCLUDING COAL SLAG) OR ALUMINUM OXIDE, - OR - POWER TOOL CLEAN TO BARE METAL, SSPC-SP 11	ONE COAT MIL-PRF-23236 TYPE VII, CLASS 5 OR 7, 10 - 12 MILS	ONE COAT MIL-PRF-23236 TYPE VII, CLASS 5 OR 7, 10 - 12 MILS		ONE COAT MIL-PRF-24635 TYPE V OR VI, CLASS 2, GRADE B OR C, COMPOSITION 2, 5 - 8 MILS	ONE COAT MIL-PRF-24635 TYPE V OR VI, CLASS 2, GRADE B OR C, COMPOSITION 2, 5 - 8 MILS	ONE COAT MIL-PRF-24635 TYPE V OR VI, CLASS 2, GRADE B OR C, COMPOSITION 2, 5 - 8 MILS

TABLE 2 ALUMINUM SURFACES  SURFACE SHIPS	LINE	A SURFACE PREPARATION	B PRIMER	C	D	E HORIZONTAL SURFACES DECKS & FITTINGS	F MASTS & STACKS EXPOSED TO GASES	G VERTICAL SURFACES
PCMS (NEW TILE INSTALLATION AND REPAIR OR REINSTALLATION GREATER THAN 15 SQUARE FEET)	79	THOROUGH ABRASIVE BLAST CLEANING OF NON-FERROUS METALS, SSPC-SP 17 USING MIL-A-22262 QUALIFIED MEDIA (EXCLUDING COAL SLAG) OR ALUMINUM OXIDE,	ONE COAT MIL-PRF-23236 TYPE VII, CLASS 5 OR 7, 10 - 12 MILS	ONE COAT MIL-PRF-23236, TYPE VII, CLASS 5 OR 7, 10 - 12 MILS				
	80	THOROUGH ABRASIVE BLAST CLEANING OF NON-FERROUS METALS, SSPC-SP 17 USING MIL-A-22262 QUALIFIED MEDIA (EXCLUDING COAL SLAG) OR ALUMINUM OXIDE,	ONE COAT MIL-PRF-23236 TYPE VII, CLASS 5 OR 7, 10 - 12 MILS	ONE COAT MIL-PRF-23236, TYPE VII, CLASS 5 OR 7, 10 - 12 MILS		ONE COAT MIL-PRF-24635 TYPE V OR VI, CLASS 2, GRADE B OR C, COMPOSITION 2, 5 - 8 MILS  SEE NOTE (87)	ONE COAT MIL-PRF-24635 TYPE V OR VI, CLASS 2, GRADE B OR C, COMPOSITION 2, 5 - 8 MILS  SEE NOTE (87)	ONE COAT MIL-PRF-24635 TYPE V OR VI, CLASS 2, GRADE B OR C, COMPOSITION 2, 5 - 8 MILS  SEE NOTE (87)
	81	THOROUGH ABRASIVE BLAST CLEANING OF NON-FERROUS METALS, SSPC-SP 17 USING MIL-A-22262 QUALIFIED MEDIA (EXCLUDING COAL SLAG) OR ALUMINUM OXIDE,	"SINGLE COAT"  ONE COAT MIL-PRF-23236 TYPE VII CLASS 5/18 OR 7/18, 20-30 MILS  SEE NOTE (24)					
	82	THOROUGH ABRASIVE BLAST CLEANING OF NON-FERROUS METALS, SSPC-SP 17 USING MIL-A-22262 QUALIFIED MEDIA (EXCLUDING COAL SLAG) OR ALUMINUM OXIDE,	"SINGLE COAT"  ONE COAT MIL-PRF-23236 TYPE VII CLASS 5/18 OR 7/18, 20-30 MILS  SEE NOTE (24)			FULL COAT MIL-PRF-24635 TYPE V OR VI, CLASS 2, GRADE B OR C, COMPOSITION 2, 5 - 8 MILS  SEE NOTE (87)	FULL COAT MIL-PRF-24635 TYPE V OR VI, CLASS 2, GRADE B OR C, COMPOSITION 2, 5 - 8 MILS  SEE NOTE (87)	FULL COAT MIL-PRF-24635 TYPE V OR VI, CLASS 2, GRADE B OR C, COMPOSITION 2, 5 - 8 MILS  SEE NOTE (87)

TABLE 2 GRP FIBERGLASS SURFACES  SURFACE SHIPS	LINE	A SURFACE PREPARATION	B PRIMER	C	D	E HORIZONTAL SURFACES DECKS & FITTINGS	F MASTS & STACKS EXPOSED TO GASES	G VERTICAL SURFACES
EXTERIOR SURFACES ABOVE BOOTTOP  SEE NOTES (2) & (70)	83	HIGH PRESSURE WASH TO REMOVE MARINE GROWTH & LOOSE PAINT - OR - TOUCH-UP OR REMOVAL OF PAINT SYSTEM TO SOUND PRIMER BY LIGHT ABRASIVE BLASTING WITH WALNUT SHELLS -- & -- SPOT CLEAN, CHAP 631, PARA 631-5.2.6  SEE NOTE (21)	ONE COAT F-150, MIL-DTL-24441, TYPE IV, 4 - 6 MILS        SEE NOTE (29)		ONE STRIPE COAT MIL-DTL-24441, TYPE IV, 4 - 6 MILS        SEE NOTE (29)	ONE COAT DECK GRAY MIL-PRF-24635 TYPE V, CLASS 2, GRADE B OR C, COMPOSITION 2, 5 - 8 MILS	ONE COAT HAZE GRAY MIL-PRF-24635 TYPE V, CLASS 2, GRADE B, COMPOSITION 2, 5 - 8 MILS        SEE NOTES (42) & (85)	ONE COAT HAZE GRAY MIL-PRF-24635 TYPE V, CLASS 2, GRADE B, COMPOSITION 2, 5 - 8 MILS        IDENTIFICATION MARKINGS: PAINT DESIGNATIONS & MARKINGS MIL-PRF-24635, COMPOSITION 2, 5 - 8 MILS  SEE NOTES (43) & (85)
	83A	HIGH PRESSURE WASH TO REMOVE MARINE GROWTH & LOOSE PAINT - OR - TOUCH-UP OR REMOVAL OF PAINT SYSTEM TO SOUND PRIMER BY LIGHT ABRASIVE BLASTING WITH WALNUT SHELLS -- & -- SPOT CLEAN, CHAP 631, PARA 631-5.2.6  SEE NOTE (21)	ONE COAT F-150, MIL-DTL-24441, TYPE IV, 4 - 6 MILS        SEE NOTE (29)		ONE STRIPE COAT MIL-DTL-24441, TYPE IV, 4 - 6 MILS -- & -- ONE COAT MIL-DTL-24441, TYPE IV, 4 - 6 MILS        SEE NOTE (29)	ONE COAT DECK GRAY MIL-PRF-24635 TYPE V, CLASS 2, GRADE B OR C, COMPOSITION 1, 2 - 3 MILS	ONE COAT HAZE GRAY MIL-PRF-24635 TYPE V, CLASS 2, GRADE B, COMPOSITION 1, 2 - 3 MILS - OR - MIL-PRF-24763, TYPE II OR III, CLASS 2, GRADE B, 2 - 4 MILS        SEE NOTES (42) & (85)	ONE COAT HAZE GRAY MIL-PRF-24635 TYPE V, CLASS 2, GRADE B, COMPOSITION 1, 2 - 3 MILS - OR - MIL-PRF-24763, TYPE II OR III, CLASS 2, GRADE B, 2 - 4 MILS        IDENTIFICATION MARKINGS: PAINT DESIGNATIONS & MARKINGS MIL-PRF-24635, COMPOSITION 1, 2 - 3 MILS  SEE NOTES (43) & (85)

TABLE 2 GRP FIBERGLASS SURFACES  SURFACE SHIPS	LINE	A SURFACE PREPARATION	B PRIMER	C	D	E HORIZONTAL SURFACES DECKS & FITTINGS	F MASTS & STACKS EXPOSED TO GASES	G VERTICAL SURFACES
EXTERIOR WALK AREAS ALL EXTERIOR DECK AREAS	84	POWER TOOL CLEAN TO CLEAN FIBERGLASS (DISC SANDER, ETC.) - OR - POWER TOOL CLEAN TO POLYURETHANE OVERLAY SUBSTRATE (DISC SANDER, ETC.) - OR - HYDROBLAST TO CLEAN FIBERGLASS SEE NOTES (25) & (62)	PROPRIETARY NONSKID PRIMER LISTED ON THE QPL FOR MIL-PRF-24667  SEE NOTE (7)			ONE COAT MIL-PRF-24667, TYPE I ROLLABLE, II ROLLABLE, III ROLLABLE RESILIENT, OR IV SPRAYABLE, COMP G  SEE NOTES (19), & (22)		
	85	POWER TOOL CLEAN TO CLEAN FIBERGLASS (DISC SANDER, ETC.) - OR - POWER TOOL CLEAN TO POLYURETHANE OVERLAY SUBSTRATE (DISC SANDER, ETC.) - OR - HYDROBLAST TO CLEAN FIBERGLASS SEE NOTES (25) & (62)	ONE COAT F-150, MIL-DTL-24441, TYPE IV, 4 - 6 MILS			ONE COAT DECK GRAY MIL-PRF-24635 TYPE V, CLASS 2, GRADE B, COMPOSITION 2, 5 - 8 MILS --OR-- ONE COAT DECK GRAY MIL-PRF-24635 TYPE V, CLASS 2, GRADE B, COMPOSITION 1, 2 - 3 MILS --&-- APPLICATION OF MIL-PRF-24667, TYPE XI, COMPOSITION PS  SEE NOTE (19)		
PCMS (NEW TILE INSTALLATION) (GRP)	86	SOAP & WATER CLEAN & HAND SAND  SEE NOTE (71)	ONE COAT F-150, MIL-DTL-24441, TYPE IV, 4 - 6 MILS					



TABLE 2 WOOD SURFACES SURFACE SHIPS	LINE	A SURFACE PREPARATION	B PRIMER	C	D	E HORIZONTAL SURFACES DECKS & FITTINGS	F MASTS & STACKS EXPOSED TO GASES	G VERTICAL SURFACES
EXTERIOR ABOVE BOOTTOPPING	87	HAND TOOL CLEAN - OR - POWER TOOL CLEAN TO REMOVE DETERIORATED COATINGS          SEE NOTE (71)	ONE COAT F-150, MIL-DTL-24441, TYPE IV, 4 - 6 MILS	DECKS, MASTS & SPARS:  ONE COAT DECK GRAY MIL-PRF-24635 TYPE V, GRADE B, COMPOSITION 2, 5 - 8 MILS - OR - ONE COAT DECK GRAY MIL-PRF-24635 TYPE V, GRADE B, COMPOSITION 1, 2 - 3 MILS - OR - ONE COAT BLACK MIL-PRF-24635, TYPE V, GRADE B, COMPOSITION 2, 5 - 8 MILS - OR - ONE COAT BLACK MIL-PRF-24635, TYPE V, GRADE B, COMPOSITION 1, 2 - 3 MILS	ALL OTHER SURFACES:  ONE COAT HAZE GRAY MIL-PRF-24635 TYPE V, GRADE B, COMPOSITION 2, 5 - 8 MILS - OR - ONE COAT HAZE GRAY MIL-PRF-24635 TYPE V, GRADE B, COMPOSITION 1, 2 - 3 MILS			IDENTIFICATION MARKINGS:  PAINT DESIGNATIONS & MARKINGS MIL- PRF-24635, COMPOSITION 2, 5 - 8 MILS OR MIL-PRF- 24635, COMPOSITION 1, 2 - 3 MILS          SEE NOTE (43)

TABLE 3 STEEL SURFACES  SURFACE SHIPS	LINE	A SURFACE PREPARATION	B PRIMER	C	D BULKHEADS & OVERHEADS	E DECKS	F INSULATION	G MARKINGS
INTERIOR COMPARTMENTS SEE NOTE (17)	1	HAND TOOL CLEANING, SSPC-SP 2  SEE NOTE (28)	2 COATS FORMULA 84, TT-P-645, ALKYD, 2 - 4 MILS/COAT - OR - ONE COAT MIL-PRF-23236, TYPE V, VI, OR VII, CLASS 5 OR 7, 4 - 8 MILS --OR-- ONE COAT MIL-PRF-32584, TYPE I OR II, 10 - 12 MILS  SEE NOTE (88) & (93)		2 COATS MIL-PRF-24596, WATER-BASED INTERIOR LATEX, 2 - 4 MILS/COAT - OR - 2 COATS MIL-DTL-24607, 2 - 4 MILS/COAT  SEE NOTE (9)	TO DECKS NOT RECEIVING COVERING:  ONE COAT MIL-PRF-32584, TYPE I OR II, 10 - 12 MILS  SEE NOTE (88)	HULL, VENTILATION & PIPING INSULATION  ONE COAT MIL-PRF-24596, WATER-BASED INTERIOR LATEX, 2 - 4 MILS - OR - ONE COAT MIL-DTL-24607, 2 - 4 MILS  IF REQUIRED FOR HIDING, ONE ADDITIONAL COAT MUST BE APPLIED.  SEE NOTES (9), (28), (41) & (94)	FOR COMPARTMENT PIPING & VENTILATION  SEE NOTE (18)
INTERIOR COMPARTMENTS (OVERCOAT) SEE NOTE (17)	2	HAND TOOL CLEANING, SSPC-SP 2  SEE NOTE (28)	SAME AS LINE ONE FOR BARE METAL AREAS		SAME AS LINE ONE EXCEPT ONE COAT	TO DECKS NOT RECEIVING COVERING:  ONE COAT MIL-PRF-32584, TYPE I OR II, 10 - 12 MILS  SEE NOTE (88)	HULL, VENTILATION & PIPING INSULATION  ONE COAT MIL-PRF-24596, WATER-BASED INTERIOR LATEX, 2 - 4 MILS - OR - ONE COAT MIL-DTL-24607, 2 - 4 MILS  IF REQUIRED FOR HIDING, ONE ADDITIONAL COAT MUST BE APPLIED.  SEE NOTES (9), (28), (41) & (94)	FOR COMPARTMENT PIPING & VENTILATION  SEE NOTE (18)
WELDING BAYS AND LIGHT TRAPS	3	HAND TOOL CLEANING, SSPC-SP 2  SEE NOTE (28)	2 COATS FORMULA 84, TT-P-645, ALKYD, 2 - 4 MILS/COAT - OR - ONE COAT MIL-PRF-23236, TYPE V, VI, OR VII, CLASS 5 OR 7, 4 - 8 MILS --OR-- ONE COAT MIL-PRF-32584, TYPE I OR II, 10 - 12 MILS  SEE NOTE (88) & (93)		ONE COAT BLACK, LOW GLOSS, MIL-PRF-23236, TYPE V VI, OR VII, 4 - 8 MILS	ONE COAT BLACK, SEMI-GLOSS, MIL-PRF-23236, TYPE V VI, OR VII, 4 - 8 MILS - OR - ONE COAT MIL-PRF-32584, TYPES I OR II, 10 - 12 MILS  SEE NOTE (88)		

TABLE 3 STEEL SURFACES  SURFACE SHIPS	LINE	A SURFACE PREPARATION	B PRIMER	C	D BULKHEADS & OVERHEADS	E DECKS	F INSULATION	G MARKINGS
WET SPACES (WASH ROOMS, WATER CLOSETS, SHOWER STALLS, GALLEYS, SCULLERIES, & STOREROOMS WHERE HEAVY CONDENSATION IS COMMON)	4	POWER TOOL CLEAN TO BARE METAL, SSPC-SP 11 (DECKS)  POWER TOOL CLEANING, SSPC-SP 3 (BULKHEADS/ OVERHEADS)  SEE NOTE (28)	"SINGLE COAT"  ONE COAT MIL-PRF-23236, TYPE VII, CLASS 17/18, 20-30 MILS  SEE NOTE (24)				HULL, VENTILATION & PIPING INSULATION  ONE COAT MIL-PRF-24596, WATER-BASED INTERIOR LATEX, 2 - 4 MILS - OR - ONE COAT MIL-DTL-24607, 2 - 4 MILS  IF REQUIRED FOR HIDING, ONE ADDITIONAL COAT MUST BE APPLIED.  SEE NOTES (9), (28), (41) & (94)	FOR COMPARTMENT PIPING & VENTILATION        SEE NOTE (18)
	5	POWER TOOL CLEAN TO BARE METAL, SSPC-SP 11 (DECKS)  POWER TOOL CLEANING, SSPC-SP 3 (BULKHEADS/ OVERHEADS)  SEE NOTE (28)	ONE COAT MIL-PRF-23236, TYPE VII, CLASS 15B OR 17, 6 - 8 MILS --OR-- ONE COAT MIL-PRF-32584, TYPE II, 10 - 12 MILS  SEE NOTE (88)		ONE COAT MIL-PRF-23236, TYPE VII, CLASS 15B or 17, 6 - 8 MILS	TO DECKS NOT RECEIVING COVERING:  ONE COAT MIL-PRF-32584, TYPE II, 10 - 12 MILS  SEE NOTE (88)	HULL, VENTILATION & PIPING INSULATION  ONE COAT MIL-PRF-24596, WATER-BASED INTERIOR LATEX, 2 - 4 MILS - OR - ONE COAT MIL-DTL-24607, 2 - 4 MILS  IF REQUIRED FOR HIDING, ONE ADDITIONAL COAT MUST BE APPLIED.  SEE NOTES (9), (28), (41) & (94)	FOR COMPARTMENT PIPING & VENTILATION        SEE NOTE (18)
INTERIOR COMPARTMENTS  SEE NOTE (17)	6	POWER TOOL CLEAN TO BARE METAL, SSPC-SP 11     SEE NOTE (28)	2 COATS FORMULA 84, TT-P-645, 2 - 4 MILS/COAT --OR-- ONE COAT MIL-PRF-23236, TYPE V, VI, OR VII, CLASS 5 OR 7, 4 - 8 MILS --OR-- ONE COAT MIL-PRF-32584, TYPES I OR II, 10 - 12 MILS  SEE NOTE (88) & (93)		2 COATS MIL-PRF-24596, WATER-BASED INTERIOR LATEX, 2 - 4 MILS/COAT - OR - 2 COATS MIL-DTL-24607, 2 - 4 MILS/COAT  SEE NOTE (9)	TO DECKS NOT RECEIVING COVERING:  ONE COAT MIL-PRF-32584, TYPES I OR II, 10 - 12 MILS  SEE NOTE (88)	HULL, VENTILATION & PIPING INSULATION  ONE COAT MIL-PRF-24596, WATER-BASED INTERIOR LATEX, 2 - 4 MILS - OR - ONE COAT MIL-DTL-24607, 2 - 4 MILS  IF REQUIRED FOR HIDING, ONE ADDITIONAL COAT MUST BE APPLIED.  SEE NOTES (9), (28), (41) & (94)	FOR COMPARTMENT PIPING & VENTILATION        SEE NOTE (18)

TABLE 3 STEEL SURFACES  SURFACE SHIPS	LINE	A SURFACE PREPARATION	B PRIMER	C	D BULKHEADS & OVERHEADS	E DECKS	F INSULATION	G MARKINGS
INTERIOR COMPARTMENTS (OVERCOAT)  SEE NOTE (17)	7	POWER TOOL CLEANING, SSPC-SP 3  SEE NOTE (28)	SAME AS LINE ONE FOR BARE METAL AREAS		SAME AS LINE ONE EXCEPT ONE COAT	TO DECKS NOT RECEIVING COVERING:  ONE COAT MIL-PRF-32584, TYPE I OR II, 10 – 12 MILS       SEE NOTE (88)	HULL, VENTILATION & PIPING INSULATION  ONE COAT MIL-PRF-24596, WATER-BASED INTERIOR LATEX, 2 - 4 MILS - OR - ONE COAT MIL-DTL-24607, 2 - 4 MILS  IF REQUIRED FOR HIDING, ONE ADDITIONAL COAT MUST BE APPLIED.  SEE NOTES (9), (28), (41) & (94)	FOR COMPARTMENT PIPING & VENTILATION       SEE NOTE (18)
WELDING BAYS AND LIGHT TRAPS	8	POWER TOOL CLEANING, SSPC-SP 3  SEE NOTE (28)	2 COATS FORMULA 84, TT-P- 645, 2 - 4 MILS/COAT --OR-- ONE COAT MIL-PRF-23236, TYPE V, VI, OR VII, CLASS 5 OR 7, 4 - 8 MILS --OR-- ONE COAT MIL-PRF-32584, TYPES I OR II, 10 – 12 MILS  SEE NOTE (88) & (93)		ONE COAT BLACK, LOW GLOSS, MIL-PRF-23236, TYPE V VI, OR VII, 4 - 8 MILS	ONE COAT BLACK, SEMI- GLOSS, MIL-PRF-23236, TYPE V VI, OR VII, 4 - 8 MILS - OR - ONE COAT MIL-PRF-32584, TYPES I OR II, 10 – 12 MILS  SEE NOTE (88)		
PROPULSION SHAFT (INSIDE THE HULL) INCLUDING HYDRAULIC COUPLING NUTS AND BOLTS	8A	HAND TOOL CLEANING, SSPC-SP 2       SEE NOTES (28) & (71)	ONE COAT MIL-PRF-23236, TYPE VII, CLASS 17, 6 - 8 MILS			ONE FULL COAT MIL-PRF- 23236, TYPE VII, CLASS 17, 6 - 8 MILS		

TABLE 3 STEEL SURFACES  SURFACE SHIPS	LINE	A SURFACE PREPARATION	B PRIMER	C	D BULKHEADS & OVERHEADS	E DECKS	F INSULATION	G MARKINGS
MACHINERY SPACES, BILGES & DISTILLING UNIT PANS  CVN 78 CLASS CONDENSATE PUMP RECESSED AREA (TO INCLUDE SUMP, TANK TOP, VERTICAL BULKHEADS, MANWAY COVERS AND COAMINGS AND RAMP SURFACES)  SEE NOTE (77)	9	POWER TOOL CLEAN TO BARE METAL, SSPC-SP 11 - OR - WATERJETTING TO NACE/SSPC-SP WJ-2/L - OR - NEAR WHITE METAL BLAST, NACE 2/SSPC-SP 10 - OR - SSPC-SP 10/L (WAB)/NACE WAB-2/L  SEE NOTES (28) & (78)	ONE COAT MIL-PRF-23236, TYPE VII, CLASS 17, 6 - 8 MILS       SEE NOTE (84)		ABOVE BILGE AREA:  2 COATS F-124, MIL-DTL-24607, 2 - 4 MILS/COAT	BILGE AREA:  ONE FULL COAT MIL-PRF- 23236, TYPE VII, CLASS 17, 6 - 8 MILS    SEE NOTE (4), & (84)	HULL, VENTILATION & PIPING INSULATION  ONE COAT MIL-PRF-24596, WATER-BASED INTERIOR LATEX, 2 - 4 MILS - OR - ONE COAT MIL-DTL-24607, 2 - 4 MILS  IF REQUIRED FOR HIDING, ONE ADDITIONAL COAT MUST BE APPLIED.  SEE NOTES (9), (28), (41) & (94)	
	10	POWER TOOL CLEAN TO BARE METAL, SSPC-SP 11 - OR - WATERJETTING TO NACE/SSPC-SP WJ-2/L - OR - NEAR WHITE METAL BLAST, NACE 2/SSPC-SP 10 - OR - SSPC-SP 10/L (WAB)/NACE WAB-2/L  SEE NOTES (28) & (78)	ONE COAT MIL-PRF-23236, TYPE VII, CLASS 15B, 6 - 8 MILS      SEE NOTE (84)		ABOVE BILGE AREA:  2 COATS F-124, MIL-DTL-24607, 2 - 4 MILS/COAT	BILGE AREA:  ONE FULL COAT MIL-PRF- 23236, TYPE VII, CLASS 15B, 6 - 8 MILS    SEE NOTE (4), & (84)	HULL, VENTILATION & PIPING INSULATION  ONE COAT MIL-PRF-24596, WATER-BASED INTERIOR LATEX, 2 - 4 MILS - OR - ONE COAT MIL-DTL-24607, 2 - 4 MILS  IF REQUIRED FOR HIDING, ONE ADDITIONAL COAT MUST BE APPLIED.  SEE NOTES (9), (28), (41) & (94)	
	11	NEAR WHITE METAL BLAST, NACE 2/SSPC-SP 10      SEE NOTES (28) & (78)	ONE COAT MIL-PRF-23236, TYPE VII, CLASS 5, 4 - 8 MILS      SEE NOTE (84)		ABOVE BILGE AREA:  2 COATS F-124, MIL-DTL-24607, 2 - 4 MILS/COAT	BILGE AREA:  ONE FULL COAT MIL-PRF- 23236, TYPE VII, CLASS 5, 10 - 12 MILS    SEE NOTES (4), & (84)	HULL, VENTILATION & PIPING INSULATION  ONE COAT MIL-PRF-24596, WATER-BASED INTERIOR LATEX, 2 - 4 MILS - OR - ONE COAT MIL-DTL-24607, 2 - 4 MILS  IF REQUIRED FOR HIDING, ONE ADDITIONAL COAT MUST BE APPLIED.  SEE NOTES (9), (28), (41) & (94)	

TABLE 3 STEEL SURFACES  SURFACE SHIPS	LINE	A SURFACE PREPARATION	B PRIMER	C	D BULKHEADS & OVERHEADS	E DECKS	F INSULATION	G MARKINGS
	12	NEAR WHITE METAL BLAST, NACE 2/SSPC-SP 10  SEE NOTES (28) & (78)	"SINGLE COAT"  ONE COAT MIL-PRF-23236 TYPE VII CLASS 5/18, 20-30 MILS  SEE NOTES (24), & (84)		ABOVE BILGE AREA:  2 COATS F-124, MIL-DTL-24607, 2 - 4 MILS/COAT		HULL, VENTILATION & PIPING INSULATION  ONE COAT MIL-PRF-24596, WATER-BASED INTERIOR LATEX, 2 - 4 MILS - OR - ONE COAT MIL-DTL-24607, 2 - 4 MILS  IF REQUIRED FOR HIDING, ONE ADDITIONAL COAT MUST BE APPLIED.  SEE NOTES (9), (28), (41) & (94)	
	13	POWER TOOL CLEAN TO BARE METAL, SSPC-SP 11 (DECKS)  POWER TOOL CLEANING, SSPC-SP 3 (BULKHEADS/ OVERHEADS)  SEE NOTE (28)	"SINGLE COAT"  ONE COAT MIL-PRF-23236 TYPE VII CLASS 17/18, 20-30 MILS  SEE NOTES (24), & (84)		ABOVE BILGE AREA:  2 COATS F-124, MIL-DTL-24607, 2 - 4 MILS/COAT		HULL, VENTILATION & PIPING INSULATION  ONE COAT MIL-PRF-24596, WATER-BASED INTERIOR LATEX, 2 - 4 MILS - OR - ONE COAT MIL-DTL-24607, 2 - 4 MILS  IF REQUIRED FOR HIDING, ONE ADDITIONAL COAT MUST BE APPLIED.  SEE NOTES (9), (28), (41) & (94)	
VENT PLENUMS	14	NEAR WHITE METAL BLAST, NACE 2/SSPC-SP 10  SEE NOTES (28) & (78)	ONE COAT MIL-PRF-23236, TYPE VII, CLASS 5, 4 - 8 MILS		ONE FULL COAT HAZE GRAY OR LIGHT GRAY MIL-PRF-23236, TYPE VII, CLASS 5, 10 - 12 MILS	ONE FULL COAT HAZE GRAY OR LIGHT GRAY MIL-PRF- 23236, TYPE VII, CLASS 5, 10 - 12 MILS	2 COATS MIL-PRF-24596 GRADE A WATER BASED LATEX, GRAY, AS REQUIRED FOR HIDING (OVER INSTALLED INSULATION)  SEE NOTE (94)	
	15	NEAR WHITE METAL BLAST, NACE 2/SSPC-SP 10  SEE NOTES (28) & (78)	"SINGLE COAT"  ONE COAT MIL-PRF-23236 TYPE VII CLASS 5/18, HAZE GRAY OR LIGHT GRAY, 20-30 MILS  SEE NOTE (24)				2 COATS MIL-PRF-24596 GRADE A WATER BASED LATEX, GRAY, AS REQUIRED FOR HIDING (OVER INSTALLED INSULATION)  SEE NOTE (94)	

TABLE 3 STEEL SURFACES  SURFACE SHIPS	LINE	A SURFACE PREPARATION	B PRIMER	C	D BULKHEADS & OVERHEADS	E DECKS	F INSULATION	G MARKINGS
	16	WATERJETTING TO NACE/SSPC-SP WJ-2/L -OR- NEAR WHITE METAL BLAST, NACE 2/SSPC-SP 10 - OR - SSPC-SP 10/L (WAB)/NACE WAB-2/L	ONE COAT MIL-PRF-23236, TYPE VII, CLASS 15B OR 17, 6 - 8 MILS		ONE FULL COAT HAZE GRAY OR LIGHT GRAY MIL-PRF-23236, TYPE VII, CLASS 15B OR 17, 6 - 8 MILS	ONE FULL COAT HAZE GRAY OR LIGHT GRAY MIL-PRF-23236, TYPE VII, CLASS 15B OR 17, 6 - 8 MILS	2 COATS MIL-PRF-24596 GRADE A WATER BASED LATEX, GRAY, AS REQUIRED FOR HIDING (OVER INSTALLED INSULATION)  SEE NOTE (94)	
	16A	WATERJETTING TO NACE/SSPC-SP WJ-2/L -OR- NEAR WHITE METAL BLAST, NACE 2/SSPC-SP 10 - OR - SSPC-SP 10/L (WAB)/NACE WAB-2/L	ONE COAT MIL-PRF-23236, TYPE V OR VI, CLASS 5 OR 7, 4 - 8 MILS	ONE STRIPE COAT MIL-PRF-23236, TYPE V OR VI, CLASS 5 OR 7, 4 - 8 MILS/COAT		ONE COAT DECK GRAY MIL-PRF-24635 TYPE V OR VI, CLASS 2, GRADE B OR C, COMPOSITION 2, 5 -8 MILS	ONE COAT HAZE GRAY MIL-PRF-24635 TYPE V OR VI, CLASS 2, GRADE B OR C, COMPOSITION 2, 5 - 8 MILS	
	17	WATERJETTING TO NACE/SSPC-SP WJ-2/L -OR- NEAR WHITE METAL BLAST, NACE 2/SSPC-SP 10 - OR - SSPC-SP 10/L (WAB)/NACE WAB-2/L	"SINGLE COAT"  ONE COAT MIL-PRF-23236 TYPE VII CLASS 17/18, HAZE GRAY OR LIGHT GRAY, 20-30 MILS  SEE NOTE (24)				2 COATS MIL-PRF-24596 GRADE A WATER BASED LATEX, GRAY, AS REQUIRED FOR HIDING (OVER INSTALLED INSULATION)  SEE NOTE (94)	
CLEAN AND DIRTY SIDE OF COMBUSTION AIR INTAKES/ EXHAUST TRUNKS	18	NEAR WHITE METAL BLAST, NACE 2/SSPC-SP 10  SEE NOTES (28) & (78)	ONE COAT MIL-PRF-23236, TYPE VII, CLASS 7, 4 - 8 MILS		ONE FULL COAT HAZE GRAY OR LIGHT GRAY MIL-PRF-23236, TYPE VII, CLASS 7, 10 - 12 MILS	ONE FULL COAT HAZE GRAY OR LIGHT GRAY MIL-PRF-23236, TYPE VII, CLASS 7, 10 - 12 MILS		

TABLE 3 STEEL SURFACES  SURFACE SHIPS	LINE	A SURFACE PREPARATION	B PRIMER	C	D BULKHEADS & OVERHEADS	E DECKS	F INSULATION	G MARKINGS
	19	POWER TOOL CLEAN TO BARE METAL, SSPC-SP 11 - OR - WATERJETTING TO NACE/SSPC-SP WJ-2/L - OR - NEAR WHITE METAL BLAST, NACE 2/SSPC-SP 10 - OR - SSPC-SP 10/L (WAB)/NACE WAB-2/L  SEE NOTES (28) & (78)	ONE COAT MIL-PRF-23236, TYPE VII, CLASS 15B OR 17, 6 - 8 MILS		ONE COAT HAZE GRAY OR LIGHT GRAY MIL-PRF-23236, TYPE VII, CLASS 15B OR 17, 6 - 8 MILS	ONE COAT HAZE GRAY OR LIGHT GRAY MIL-PRF-23236, TYPE VII, CLASS 15B OR 17, 6 - 8 MILS		
	19A	POWER TOOL CLEAN TO BARE METAL, SSPC-SP 11 - OR - WATERJETTING TO NACE/SSPC-SP WJ-2/L - OR - NEAR WHITE METAL BLAST, NACE 2/SSPC-SP 10 - OR - SSPC-SP 10/L (WAB)/NACE WAB-2/L  SEE NOTES (28) & (78)	ONE COAT MIL-PRF-23236, TYPE V OR VI, CLASS 5 OR 7, 4 - 8 MILS	ONE STRIPE COAT MIL-PRF-23236, TYPE V OR VI, CLASS 5 OR 7, 4 - 8 MILS/COAT		ONE COAT DECK GRAY MIL-PRF-24635 TYPE V OR VI, CLASS 2, GRADE B OR C, COMPOSITION 2, 5 - 8 MILS	ONE COAT HAZE GRAY MIL-PRF-24635 TYPE V OR VI, CLASS 2, GRADE B OR C, COMPOSITION 2, 5 - 8 MILS	
	20	POWER TOOL CLEAN TO BARE METAL, SSPC-SP 11 (DECKS)  POWER TOOL CLEANING, SSPC-SP 3 (BULKHEADS/ OVERHEADS)  SEE NOTE (28)	"SINGLE COAT"  ONE COAT MIL-PRF-23236 TYPE VII CLASS 17/18, HAZE GRAY OR LIGHT GRAY, 20-30 MILS  SEE NOTE (24)					



TABLE 3 STEEL SURFACES  SURFACE SHIPS	LINE	A SURFACE PREPARATION	B PRIMER	C	D BULKHEADS & OVERHEADS	E DECKS	F INSULATION	G MARKINGS
FAN ROOMS	21	POWER TOOL CLEAN TO BARE METAL, SSPC-SP 11 - OR - WATERJETTING TO NACE/SSPC-SP WJ-2/L - OR - NEAR WHITE METAL BLAST, NACE 2/SSPC-SP 10 - OR - SSPC-SP 10/L (WAB)/NACE WAB-2/L  SEE NOTES (28) & (78)	ONE COAT MIL-PRF-23236, TYPE VII, CLASS 15B OR 17, 6 - 8 MILS		ONE FULL COAT MIL-PRF-23236, TYPE VII, CLASS 15B OR 17, 6 - 8 MILS	ONE FULL COAT MIL-PRF-23236, TYPE VII, CLASS 15B OR 17, 6 - 8 MILS	HULL, VENTILATION & PIPING INSULATION  ONE COAT MIL-PRF-24596, WATER-BASED INTERIOR LATEX, 2 - 4 MILS - OR - ONE COAT MIL-DTL-24607, 2 - 4 MILS  IF REQUIRED FOR HIDING, ONE ADDITIONAL COAT MUST BE APPLIED.  SEE NOTES (9), (28), (41) & (94)	
	21A	NEAR WHITE METAL BLAST, NACE 2/SSPC-SP 10	"SINGLE COAT"  ONE COAT MIL-PRF-23236 TYPE VII CLASS 17/18, 20-30 MILS					
MIXING ROOM/GAS TURBINE EXHAUST UPTAKE SPACES AND TRUNKS WITH VENTS OR LOUVERS TO THE OUTSIDE ATMOSPHERE (BULKHEADS & DECKS)	22	NEAR WHITE METAL BLAST, NACE 2/SSPC-SP 10  SEE NOTES (28) & (78)	ONE COAT MIL-PRF-23236, TYPE VII, CLASS 5, 4 - 8 MILS		ONE FULL COAT HAZE GRAY OR LIGHT GRAY MIL-PRF-23236, TYPE VII, CLASS 5, 10 - 12 MILS	ONE FULL COAT HAZE GRAY OR LIGHT GRAY MIL-PRF-23236, TYPE VII, CLASS 5, 10 - 12 MILS		
UNDER AFF PROPORTIONING UNITS (INSIDE THE COAMING)  SEE NOTE (77)	23	POWER TOOL CLEAN TO BARE METAL, SSPC-SP 11  SEE NOTES (32) & (36)	ONE COAT MIL-PRF-32584, TYPE III, 12 - 18 MILS  SEE NOTE (88)			ONE COAT MIL-PRF-32584, TYPE III, 12 - 18 MILS  SEE NOTE (88)		
INTERIOR DECK PASSAGEWAYS NOT RECEIVING DECK COVERINGS (HIGH DURABILITY DECK PAINT)  SEE NOTE (12)	24	NEAR WHITE METAL BLAST, NACE 2/SSPC-SP 10 - OR - POWER TOOL CLEAN TO BARE METAL, SSPC-SP 11	ONE COAT MIL-PRF-32584, TYPES I OR II, 10 - 12 MILS  SEE NOTE (88)			ONE COAT MIL-PRF-32584, TYPES I OR II, 10 - 12 MILS  SEE NOTE (88)		

TABLE 3 STEEL SURFACES  SURFACE SHIPS	LINE	A SURFACE PREPARATION	B PRIMER	C	D BULKHEADS & OVERHEADS	E DECKS	F INSULATION	G MARKINGS
INTERIOR STEEL SURFACES	25	NEAR WHITE METAL BLAST, NACE 2/SSPC-SP 10  SEE NOTES (28) & (78)	2 COATS FORMULA 84, TT-P-645, ALKYD, 2 - 4 MILS/COAT - OR - ONE COAT MIL-PRF-23236, TYPE V, VI, OR VII, CLASS 5 OR 7, 4 - 8 MILS --OR-- ONE COAT MIL-PRF-32584, TYPE I OR II, 10 - 12 MILS  SEE NOTE (88) & (93)		2 COATS MIL-PRF-24596, WATER-BASED INTERIOR LATEX, 2 - 4 MILS/COAT - OR - 2 COATS MIL-DTL-24607, 2 - 4 MILS/COAT  SEE NOTE (9)	TO DECKS NOT RECEIVING COVERING:  ONE COAT MIL-PRF-32584, TYPE I OR II, 10 - 12 MILS  SEE NOTE (88)	HULL, VENTILATION & PIPING INSULATION  ONE COAT MIL-PRF-24596, WATER-BASED INTERIOR LATEX, 2 - 4 MILS - OR - ONE COAT MIL-DTL-24607, 2 - 4 MILS  IF REQUIRED FOR HIDING, ONE ADDITIONAL COAT MUST BE APPLIED.  SEE NOTES (9), (28), (41) & (94)	FOR COMPARTMENT PIPING & VENTILATION       SEE NOTE (18)
	26	WATERJETTING TO NACE/SSPC-SP WJ-2/L -OR- NEAR WHITE METAL BLAST, NACE 2/SSPC-SP 10 - OR - SSPC-SP 10/L (WAB)/NACE WAB-2/L	2 COATS FORMULA 84, TT-P-645, ALKYD, 2 - 4 MILS/COAT - OR - ONE COAT MIL-PRF-23236, TYPE V, VI, OR VII, CLASS 5 OR 7, 4 - 8 MILS --OR-- ONE COAT MIL-PRF-32584, TYPE I OR II, 10 - 12 MILS  SEE NOTE (88) & (93)		2 COATS MIL-PRF-24596, WATER-BASED INTERIOR LATEX, 2 - 4 MILS/COAT - OR - 2 COATS MIL-DTL-24607, 2 - 4 MILS/COAT  SEE NOTE (9)	TO DECKS NOT RECEIVING COVERING:  ONE COAT MIL-PRF-32584, TYPE I OR II, 10 - 12 MILS  SEE NOTE (88)	HULL, VENTILATION & PIPING INSULATION  ONE COAT MIL-PRF-24596, WATER-BASED INTERIOR LATEX, 2 - 4 MILS - OR - ONE COAT MIL-DTL-24607, 2 - 4 MILS  IF REQUIRED FOR HIDING, ONE ADDITIONAL COAT MUST BE APPLIED.  SEE NOTES (9), (28), (41) & (94)	FOR COMPARTMENT PIPING & VENTILATION       SEE NOTE (18)
	27	NEAR WHITE METAL BLAST, NACE 2/SSPC-SP 10 - OR - POWER TOOL CLEAN TO BARE METAL, SSPC-SP 11	2 COATS FORMULA 84, TT-P-645, ALKYD, 2 - 4 MILS/COAT - OR - ONE COAT MIL-PRF-23236, TYPE V, VI, OR VII, CLASS 5 OR 7, 4 - 8 MILS --OR-- ONE COAT MIL-PRF-32584, TYPE I OR II, 10 - 12 MILS  SEE NOTE (88) & (93)		2 COATS MIL-PRF-24596, WATER-BASED INTERIOR LATEX, 2 - 4 MILS/COAT - OR - 2 COATS MIL-DTL-24607, 2 - 4 MILS/COAT  SEE NOTE (9)	TO DECKS NOT RECEIVING COVERING:  ONE COAT MIL-PRF-32584, TYPE I OR II, 10 - 12 MILS  SEE NOTE (88)	HULL, VENTILATION & PIPING INSULATION  ONE COAT MIL-PRF-24596, WATER-BASED INTERIOR LATEX, 2 - 4 MILS - OR - ONE COAT MIL-DTL-24607, 2 - 4 MILS  IF REQUIRED FOR HIDING, ONE ADDITIONAL COAT MUST BE APPLIED.  SEE NOTES (9), (28), (41) & (94)	FOR COMPARTMENT PIPING & VENTILATION       SEE NOTE (18)

TABLE 3 ALUMINUM SURFACES  SURFACE SHIPS	LINE	A SURFACE PREPARATION	B PRIMER	C	D BULKHEADS & OVERHEADS	E DECKS	F INSULATION	G MARKINGS
INTERIOR COMPARTMENTS  SEE NOTE (17)	28	POWER TOOL CLEAN TO BARE METAL, SSPC-SP 11,       SEE NOTES (28) & (89)	2 COATS FORMULA 84, TT-P-645, ALKYD, 2 - 4 MILS/COAT - OR - ONE COAT MIL-PRF-23236, TYPE V VI, OR VII, CLASS 5 OR 7, 4 - 8 MILS --OR-- ONE COAT MIL-PRF-32584, TYPES I OR II, 10 - 12 MILS   SEE NOTE (88) & (93)		2 COATS MIL-DTL-24607, 2 - 4 MILS/COAT - OR - 2 COATS MIL-PRF-24596, WATER-BASED INTERIOR LATEX, 2 - 4 MILS/COAT   SEE NOTE (9)	TO DECKS NOT RECEIVING COVERING:   ONE COAT MIL-PRF-32584, TYPES I OR II, 10 - 12 MILS   SEE NOTE (88)	HULL, VENTILATION & PIPING INSULATION   ONE COAT MIL-DTL-24607, 2 - 4 MILS - OR - ONE COAT MIL-PRF-24596, WATER-BASED INTERIOR LATEX, 2 - 4 MILS  IF REQUIRED FOR HIDING, ONE ADDITIONAL COAT MUST BE APPLIED.  SEE NOTES (9), (28), (41) & (94)	FOR COMPARTMENT PIPING & VENTILATION       SEE NOTE (18) & (94)
	29	HAND TOOL CLEANING, SSPC-SP 2    SEE NOTES (28) & (89)	2 COATS FORMULA 84, TT-P-645, ALKYD, 2 - 4 MILS/COAT - OR - ONE COAT MIL-PRF-23236, TYPE V VI, OR VII, CLASS 5 OR 7, 4 - 8 MILS --OR-- ONE COAT MIL-PRF-32584, TYPES I OR II, 10 - 12 MILS   SEE NOTE (88) & (93)		2 COATS MIL-DTL-24607, 2 - 4 MILS/COAT - OR - 2 COATS MIL-PRF-24596, WATER-BASED INTERIOR LATEX, 2 - 4 MILS/COAT   SEE NOTE (9)	TO DECKS NOT RECEIVING COVERING:   ONE COAT MIL-PRF-32584, TYPES I OR II, 10 - 12 MILS   SEE NOTE (88)	HULL, VENTILATION & PIPING INSULATION   ONE COAT MIL-DTL-24607, 2 - 4 MILS - OR - ONE COAT MIL-PRF-24596, WATER-BASED INTERIOR LATEX, 2 - 4 MILS  IF REQUIRED FOR HIDING, ONE ADDITIONAL COAT MUST BE APPLIED.  SEE NOTES (9), (28), (41) & (94)	FOR COMPARTMENT PIPING & VENTILATION       SEE NOTE (18) & (94)
INTERIOR COMPARTMENTS (OVERCOAT)  SEE NOTE (17)	30	HAND TOOL CLEANING, SSPC-SP 2    SEE NOTES (28) & (89)	SAME AS LINE 26 FOR BARE METAL AREAS		SAME AS LINE 28 EXCEPT ONE COAT	TO DECKS NOT RECEIVING COVERING:   ONE COAT MIL-PRF-32584, TYPES I OR II, 10 - 12 MILS   SEE NOTE (88)	HULL, VENTILATION & PIPING INSULATION   ONE COAT MIL-DTL-24607, 2 - 4 MILS - OR - ONE COAT MIL-PRF-24596, WATER-BASED INTERIOR LATEX, 2 - 4 MILS  IF REQUIRED FOR HIDING, ONE ADDITIONAL COAT MUST BE APPLIED.  SEE NOTES (9), (28), (41) & (94)	FOR COMPARTMENT PIPING & VENTILATION       SEE NOTE (18) & (94)

TABLE 3 ALUMINUM SURFACES  SURFACE SHIPS	LINE	A SURFACE PREPARATION	B PRIMER	C	D BULKHEADS & OVERHEADS	E DECKS	F INSULATION	G MARKINGS
	31	POWER TOOL CLEANING, SSPC-SP 3  SEE NOTES (28) & (89)	SAME AS LINE 26 FOR BARE METAL AREAS		SAME AS LINE 28 EXCEPT ONE COAT	TO DECKS NOT RECEIVING COVERING:  ONE COAT MIL-PRF-32584, TYPES I OR II, 10 – 12 MILS          SEE NOTE (88)	TO DECKS NOT RECEIVING COVERING:  ONE COAT MIL-PRF-32584, TYPES I OR II, 10 – 12 MILS          SEE NOTE (88)	TO DECKS NOT RECEIVING COVERING:  ONE COAT MIL-PRF- 32584, TYPES I OR II, 10 – 12 MILS          SEE NOTE (88)
WELDING BAYS AND LIGHT TRAPS	32	POWER TOOL CLEAN TO BARE METAL, SSPC-SP 11,          SEE NOTES (28) & (89)	2 COATS FORMULA 84, TT-P-645, ALKYD, 2 - 4 MILS/COAT - OR - ONE COAT MIL-PRF-23236, TYPE V VI, OR VII, CLASS 5 OR 7, 4 - 8 MILS --OR-- ONE COAT MIL-PRF-32584, TYPES I OR II, 10 – 12 MILS          SEE NOTE (88) & (93)		ONE COAT BLACK, LOW GLOSS MIL-PRF-23236, TYPE V, VI, OR VII, 4 - 8 MILS	ONE COAT BLACK, SEMI- GLOSS MIL-PRF-23236, TYPE V, VI, OR VII, 4 - 8 MILS - OR - ONE COAT MIL-PRF-32584, TYPES I OR II, 10 – 12 MILS          SEE NOTE (88)		
	33	HAND TOOL CLEANING, SSPC-SP 2          SEE NOTES (28) & (89)	2 COATS FORMULA 84, TT-P-645, ALKYD, 2 - 4 MILS/COAT - OR - ONE COAT MIL-PRF-23236, TYPE V VI, OR VII, CLASS 5 OR 7, 4 - 8 MILS --OR-- ONE COAT MIL-PRF-32584, TYPES I OR II, 10 – 12 MILS          SEE NOTE (88) & (93)		ONE COAT BLACK, LOW GLOSS MIL-PRF-23236, TYPE V, VI, OR VII, 4 - 8 MILS	ONE COAT BLACK, SEMI- GLOSS MIL-PRF-23236, TYPE V, VI, OR VII, 4 - 8 MILS - OR - ONE COAT MIL-PRF-32584, TYPES I OR II, 10 – 12 MILS          SEE NOTE (88)		

TABLE 3 ALUMINUM SURFACES  SURFACE SHIPS	LINE	A SURFACE PREPARATION	B PRIMER	C	D BULKHEADS & OVERHEADS	E DECKS	F INSULATION	G MARKINGS
WET SPACES (WASH ROOMS, WATER CLOSETS, SHOWER STALLS, GALLEYS, SCULLERIES, & STOREROOMS WHERE HEAVY CONDENSATION IS COMMON)	34	POWER TOOL CLEAN TO BARE METAL, SSPC-SP 11 (DECKS)  POWER TOOL CLEANING, SSPC-SP 3 (BULKHEADS/ OVERHEADS)  SEE NOTE (28) & (89)	"SINGLE COAT"  ONE COAT MIL-PRF-23236 TYPE VII CLASS 17/18, 20-30 MILS  SEE NOTE (24)				HULL, VENTILATION & PIPING INSULATION  ONE COAT MIL-DTL-24607, 2 - 4 MILS - OR - ONE COAT MIL-PRF-24596, WATER-BASED INTERIOR LATEX, 2 - 4 MILS  IF REQUIRED FOR HIDING, ONE ADDITIONAL COAT MUST BE APPLIED.  SEE NOTES (9), (28), (41) & (94)	FOR COMPARTMENT PIPING & VENTILATION          SEE NOTE (18) & (94)
	35	POWER TOOL CLEAN TO BARE METAL, SSPC-SP 11 (DECKS)  POWER TOOL CLEANING, SSPC-SP 3 (BULKHEADS/ OVERHEADS)  SEE NOTE (28) & (89)	ONE COAT MIL-PRF-23236, TYPE VII, CLASS 15B OR 17, 6 - 8 MILS --OR-- ONE COAT MIL-PRF-32584, TYPE II, 10 - 12 MILS  SEE NOTE (88)			TO DECKS NOT RECEIVING COVERING:  ONE COAT MIL-PRF-32584, TYPE II, 10 - 12 MILS  SEE NOTE (88)	HULL, VENTILATION & PIPING INSULATION  ONE COAT MIL-DTL-24607, 2 - 4 MILS - OR - ONE COAT MIL-PRF-24596, WATER-BASED INTERIOR LATEX, 2 - 4 MILS  IF REQUIRED FOR HIDING, ONE ADDITIONAL COAT MUST BE APPLIED.  SEE NOTES (9), (28), (41) & (94)	FOR COMPARTMENT PIPING & VENTILATION          SEE NOTE (18) & (94)
MACHINERY SPACES & BILGES	36	POWER TOOL CLEAN TO BARE METAL, SSPC-SP 11 - OR - WATERJETTING TO NACE/SSPC-SP WJ-2 - OR - THOROUGH ABRASIVE BLAST CLEANING OF NON-FERROUS METALS, SSPC-SP 17 USING MIL-A-22262 QUALIFIED MEDIA (EXCLUDING COAL SLAG) OR ALUMINUM OXIDE  SEE NOTES (28), (78), (89), & (90)	ONE COAT MIL-PRF-23236, TYPE VII, CLASS 17, 6 - 8 MILS		ABOVE BILGE AREA:  2 COATS F-124, MIL-DTL-24607, 2 - 4 MILS/COAT	BILGE AREA:  ONE FULL COAT MIL-PRF-23236, TYPE VII, CLASS 17, 6 - 8 MILS	HULL, VENTILATION & PIPING INSULATION  ONE COAT MIL-DTL-24607, 2 - 4 MILS - OR - ONE COAT MIL-PRF-24596, WATER-BASED INTERIOR LATEX, 2 - 4 MILS  IF REQUIRED FOR HIDING, ONE ADDITIONAL COAT MUST BE APPLIED.  SEE NOTES (9), (28), (41) & (94)	

TABLE 3 ALUMINUM SURFACES  SURFACE SHIPS	LINE	A SURFACE PREPARATION	B PRIMER	C	D BULKHEADS & OVERHEADS	E DECKS	F INSULATION	G MARKINGS
	37	POWER TOOL CLEAN TO BARE METAL, SSPC-SP 11 - OR - WATERJETTING TO NACE/SSPC-SP WJ-2 - OR - THOROUGH ABRASIVE BLAST CLEANING OF NON-FERROUS METALS, SSPC-SP 17 USING MIL-A-22262 QUALIFIED MEDIA (EXCLUDING COAL SLAG) OR ALUMINUM OXIDE  SEE NOTES (28), (78), (89), & (90)	ONE COAT MIL-PRF-23236, TYPE VII, CLASS 15B, 6 - 8 MILS		ABOVE BILGE AREA:  2 COATS F-124, MIL-DTL-24607, 2 - 4 MILS/COAT	BILGE AREA:  ONE FULL COAT MIL-PRF-23236, TYPE VII, CLASS 15B, 6 - 8 MILS  SEE NOTE (4)	HULL, VENTILATION & PIPING INSULATION  ONE COAT MIL-DTL-24607, 2 - 4 MILS - OR - ONE COAT MIL-PRF-24596, WATER-BASED INTERIOR LATEX, 2 - 4 MILS  IF REQUIRED FOR HIDING, ONE ADDITIONAL COAT MUST BE APPLIED.  SEE NOTES (9), (28), (41) & (94)	
	38	THOROUGH ABRASIVE CLEANING OF NON-FERROUS METALS, SSPC-SP 17 USING MIL-A-22262 QUALIFIED MEDIA (EXCLUDING COAL SLAG) OR ALUMINUM OXIDE  SEE NOTES (28) & (78)	ONE COAT MIL-PRF-23236, TYPE VII, CLASS 5, 4 - 8 MILS		ABOVE BILGE AREA:  2 COATS F-124, MIL-DTL-24607, 2 - 4 MILS/COAT	BILGE AREA:  ONE FULL COAT MIL-PRF-23236, TYPE VII, CLASS 5, 10 - 12 MILS  SEE NOTE (4)	HULL, VENTILATION & PIPING INSULATION  ONE COAT MIL-DTL-24607, 2 - 4 MILS - OR - ONE COAT MIL-PRF-24596, WATER-BASED INTERIOR LATEX, 2 - 4 MILS  IF REQUIRED FOR HIDING, ONE ADDITIONAL COAT MUST BE APPLIED.  SEE NOTES (9), (28), (41) & (94)	
	39	THOROUGH ABRASIVE CLEANING OF NON-FERROUS METALS, SSPC-SP 17 USING MIL-A-22262 QUALIFIED MEDIA (EXCLUDING COAL SLAG) OR ALUMINUM OXIDE  SEE NOTES (28) & (78)	"SINGLE COAT"  ONE COAT MIL-PRF-23236 TYPE VII CLASS 5/18, 20-30 MILS  SEE NOTE (24)		ABOVE BILGE AREA:  2 COATS F-124, MIL-DTL-24607, 2 - 4 MILS/COAT		HULL, VENTILATION & PIPING INSULATION  ONE COAT MIL-DTL-24607, 2 - 4 MILS - OR - ONE COAT MIL-PRF-24596, WATER-BASED INTERIOR LATEX, 2 - 4 MILS  IF REQUIRED FOR HIDING, ONE ADDITIONAL COAT MUST BE APPLIED.  SEE NOTES (9), (28), (41) & (94)	

TABLE 3 ALUMINUM SURFACES  SURFACE SHIPS	LINE	A SURFACE PREPARATION	B PRIMER	C	D BULKHEADS & OVERHEADS	E DECKS	F INSULATION	G MARKINGS
	40	POWER TOOL CLEAN TO BARE METAL, SSPC-SP 11 - OR - WATERJETTING TO NACE/SSPC-SP WJ-2 - OR - THOROUGH ABRASIVE BLAST CLEANING OF NON-FERROUS METALS, SSPC-SP 17 USING MIL-A-22262 QUALIFIED MEDIA (EXCLUDING COAL SLAG) OR ALUMINUM OXIDE  SEE NOTES (28), (78), (89), & (90)	"SINGLE COAT"  ONE COAT MIL-PRF-23236 TYPE VII CLASS 17/18, 20-30 MILS  SEE NOTE (24)		ABOVE BILGE AREA:  2 COATS F-124, MIL-DTL-24607, 2 - 4 MILS/COAT		HULL, VENTILATION & PIPING INSULATION  ONE COAT MIL-DTL-24607, 2 - 4 MILS - OR - ONE COAT MIL-PRF-24596, WATER-BASED INTERIOR LATEX, 2 - 4 MILS  IF REQUIRED FOR HIDING, ONE ADDITIONAL COAT MUST BE APPLIED.  SEE NOTES (9), (28), (41) & (94)	
VENT PLENUMS	41	THOROUGH ABRASIVE CLEANING OF NON-FERROUS METALS, SSPC-SP 17 USING MIL-A-22262 QUALIFIED MEDIA (EXCLUDING COAL SLAG) OR ALUMINUM OXIDE  SEE NOTES (28) & (78)	ONE COAT MIL-PRF-23236, TYPE VII, CLASS 5, 4 - 8 MILS		ONE FULL COAT HAZE GRAY OR LIGHT GRAY MIL-PRF-23236, TYPE VII, CLASS 5, 10 - 12 MILS	ONE FULL COAT HAZE GRAY OR LIGHT GRAY MIL-PRF-23236, TYPE VII, CLASS 5, 10 - 12 MILS	2 COATS MIL-PRF-24596 GRADE A WATER BASED LATEX, GRAY, AS REQUIRED FOR HIDING (OVER INSTALLED INSULATION)  SEE NOTE (94)	
	41A	THOROUGH ABRASIVE CLEANING OF NON-FERROUS METALS, SSPC-SP 17 USING MIL-A-22262 QUALIFIED MEDIA (EXCLUDING COAL SLAG) OR ALUMINUM OXIDE  SEE NOTES (28) & (78)	ONE COAT MIL-PRF-23236, TYPE VII, CLASS 7, 4 - 8 MILS	ONE STRIPE COAT MIL-PRF-23236, TYPE V OR VI, CLASS 7, 4 - 8 MILS/COAT		ONE COAT DECK GRAY MIL-PRF-24635 TYPE V OR VI, CLASS 2, GRADE B OR C, COMPOSITION 2, 5 - 8 MILS	ONE COAT HAZE GRAY MIL-PRF-24635 TYPE V OR VI, CLASS 2, GRADE B OR C, COMPOSITION 2, 5 - 8 MILS	

TABLE 3 ALUMINUM SURFACES  SURFACE SHIPS	LINE	A SURFACE PREPARATION	B PRIMER	C	D BULKHEADS & OVERHEADS	E DECKS	F INSULATION	G MARKINGS
	42	THOROUGH ABRASIVE CLEANING OF NON-FERROUS METALS, SSPC-SP 17 USING MIL-A-22262 QUALIFIED MEDIA (EXCLUDING COAL SLAG) OR ALUMINUM OXIDE SEE NOTES (28) & (78)	"SINGLE COAT"  ONE COAT MIL-PRF-23236 TYPE VII CLASS 5/18, HAZE GRAY OR LIGHT GRAY, 20-30 MILS  SEE NOTE (24)				2 COATS MIL-PRF-24596 GRADE A WATER BASED LATEX, GRAY, AS REQUIRED FOR HIDING (OVER INSTALLED INSULATION)  SEE NOTE (94)	
	43	WATERJETTING TO NACE/SSPC-SP WJ-2 - OR - THOROUGH ABRASIVE BLAST CLEANING OF NON-FERROUS METALS, SSPC-SP 17 USING MIL-A-22262 QUALIFIED MEDIA (EXCLUDING COAL SLAG) OR ALUMINUM OXIDE SEE NOTES (90)	ONE COAT MIL-PRF-23236, TYPE VII, CLASS 17, 6 - 8 MILS		ONE FULL COAT HAZE GRAY OR LIGHT GRAY MIL-PRF-23236, TYPE VII, CLASS 17, 6 - 8 MILS	ONE FULL COAT HAZE GRAY OR LIGHT GRAY MIL-PRF-23236, TYPE VII, CLASS 17, 6 - 8 MILS	2 COATS MIL-PRF-24596 GRADE A WATER BASED LATEX, GRAY, AS REQUIRED FOR HIDING (OVER INSTALLED INSULATION)  SEE NOTE (94)	
	44	WATERJETTING TO NACE/SSPC-SP WJ-2 - OR - THOROUGH ABRASIVE BLAST CLEANING OF NON-FERROUS METALS, SSPC-SP 17 USING MIL-A-22262 QUALIFIED MEDIA (EXCLUDING COAL SLAG) OR ALUMINUM OXIDE SEE NOTES (90)	ONE COAT MIL-PRF-23236, TYPE VII, CLASS 15B, 6 - 8 MILS		ONE FULL COAT HAZE GRAY OR LIGHT GRAY MIL-PRF-23236, TYPE VII, CLASS 15B, 6 - 8 MILS	ONE FULL COAT HAZE GRAY OR LIGHT GRAY MIL-PRF-23236, TYPE VII, CLASS 15B, 6 - 8 MILS	2 COATS MIL-PRF-24596 GRADE A WATER BASED LATEX, GRAY, AS REQUIRED FOR HIDING (OVER INSTALLED INSULATION)  SEE NOTE (94)	
	45	WATERJETTING TO NACE/SSPC-SP WJ-2 - OR - THOROUGH ABRASIVE BLAST CLEANING OF NON-FERROUS METALS, SSPC-SP 17 USING MIL-A-22262 QUALIFIED MEDIA (EXCLUDING COAL SLAG) OR ALUMINUM OXIDE SEE NOTES (90)	"SINGLE COAT"  ONE COAT MIL-PRF-23236 TYPE VII CLASS 17/18, HAZE GRAY OR LIGHT GRAY, 20-30 MILS  SEE NOTE (24)				2 COATS MIL-PRF-24596 GRADE A WATER BASED LATEX, GRAY, AS REQUIRED FOR HIDING (OVER INSTALLED INSULATION)  SEE NOTE (94)	



TABLE 3 ALUMINUM SURFACES  SURFACE SHIPS	LINE	A SURFACE PREPARATION	B PRIMER	C	D BULKHEADS & OVERHEADS	E DECKS	F INSULATION	G MARKINGS
CLEAN AND DIRTY SIDE OF COMBUSTION AIR INTAKES/EXHAUST TRUNKS  SEE NOTE (66)	46	THOROUGH ABRASIVE CLEANING OF NON- FERROUS METALS, SSPC- SP 17 USING MIL-A-22262 QUALIFIED MEDIA (EXCLUDING COAL SLAG) OR ALUMINUM OXIDE  SEE NOTES (28) & (78)	ONE COAT MIL-PRF-23236, TYPE VII, CLASS 7, 4 - 8 MILS			ONE FULL COAT HAZE GRAY OR LIGHT GRAY MIL-PRF- 23236, TYPE VII, CLASS 7, 10 - 12 MILS		
	46A	THOROUGH ABRASIVE CLEANING OF NON- FERROUS METALS, SSPC- SP 17 USING MIL-A-22262 QUALIFIED MEDIA (EXCLUDING COAL SLAG) OR ALUMINUM OXIDE  SEE NOTES (28) & (78)	ONE COAT MIL-PRF-23236, TYPE VII, CLASS 7, 4 - 8 MILS	ONE STRIPE COAT MIL-PRF-23236, TYPE V OR VI, CLASS 7, 4 - 8 MILS/COAT		ONE COAT DECK GRAY MIL- PRF-24635 TYPE V OR VI, CLASS 2, GRADE B OR C, COMPOSITION 2, 5 - 8 MILS		
	47	POWER TOOL CLEAN TO BARE METAL, SSPC-SP 11 - OR - WATERJETTING TO NACE/SSPC-SP WJ-2 - OR - THOROUGH ABRASIVE BLAST CLEANING OF NON-FERROUS METALS, SSPC-SP 17 USING MIL-A- 22262 QUALIFIED MEDIA (EXCLUDING COAL SLAG) OR ALUMINUM OXIDE  SEE NOTES (28), (78), (89), & (90)	ONE COAT MIL-PRF-23236, TYPE VII, CLASS 17 6 - 8 MILS			ONE FULL COAT HAZE GRAY OR LIGHT GRAY MIL-PRF- 23236, TYPE VII, CLASS 17, 6 - 8 MILS		

TABLE 3 ALUMINUM SURFACES  SURFACE SHIPS	LINE	A SURFACE PREPARATION	B PRIMER	C	D BULKHEADS & OVERHEADS	E DECKS	F INSULATION	G MARKINGS
	48	POWER TOOL CLEAN TO BARE METAL, SSPC-SP 11 - OR - WATERJETTING TO NACE/SSPC-SP WJ-2 - OR - THOROUGH ABRASIVE BLAST CLEANING OF NON-FERROUS METALS, SSPC-SP 17 USING MIL-A-22262 QUALIFIED MEDIA (EXCLUDING COAL SLAG) OR ALUMINUM OXIDE  SEE NOTES (28), (78), (89), & (90)	ONE COAT MIL-PRF-23236, TYPE VII, CLASS 15B, 6 - 8 MILS			ONE FULL COAT HAZE GRAY OR LIGHT GRAY MIL-PRF-23236, TYPE VII, CLASS 15B, 6 - 8 MILS		
	49	POWER TOOL CLEAN TO BARE METAL, SSPC-SP 11 - OR - WATERJETTING TO NACE/SSPC-SP WJ-2 - OR - THOROUGH ABRASIVE BLAST CLEANING OF NON-FERROUS METALS, SSPC-SP 17 USING MIL-A-22262 QUALIFIED MEDIA (EXCLUDING COAL SLAG) OR ALUMINUM OXIDE  SEE NOTES (28), (78), (89), & (90)	"SINGLE COAT"  ONE COAT MIL-PRF-23236 TYPE VII CLASS 17/18, HAZE GRAY OR LIGHT GRAY, 20-30 MILS  SEE NOTE (24)					
FAN ROOMS	50	POWER TOOL CLEAN TO BARE METAL, SSPC-SP 11 - OR - WATERJETTING TO NACE/SSPC-SP WJ-2 - OR - THOROUGH ABRASIVE BLAST CLEANING OF NON-FERROUS METALS, SSPC-SP 17 USING MIL-A-22262 QUALIFIED MEDIA (EXCLUDING COAL SLAG) OR ALUMINUM OXIDE  SEE NOTES (28), (78), (89), & (90)	ONE COAT MIL-PRF-23236, TYPE VII, CLASS 15B OR 17, 6 - 8 MILS		ONE FULL COAT MIL-PRF-23236, TYPE VII, CLASS 15B OR 17, 6 - 8 MILS	ONE FULL COAT MIL-PRF-23236, TYPE VII, CLASS 15B OR 17, 6 - 8 MILS	HULL, VENTILATION & PIPING INSULATION  ONE COAT MIL-DTL-24607, 2 - 4 MILS - OR - ONE COAT MIL-PRF-24596, WATER-BASED INTERIOR LATEX, 2 - 4 MILS  IF REQUIRED FOR HIDING, ONE ADDITIONAL COAT MUST BE APPLIED.  SEE NOTES (9), (28), (41) & (94)	

TABLE 3 ALUMINUM SURFACES  SURFACE SHIPS	LINE	A SURFACE PREPARATION	B PRIMER	C	D BULKHEADS & OVERHEADS	E DECKS	F INSULATION	G MARKINGS
MIXING ROOM/GAS TURBINE EXHAUST UPTAKE SPACES AND TRUNKS WITH VENTS OR LOUVERS TO THE OUTSIDE ATMOSPHERE (BULKHEADS & DECKS)	51	THOROUGH ABRASIVE CLEANING OF NON-FERROUS METALS, SSPC-SP 17 USING MIL-A-22262 QUALIFIED MEDIA (EXCLUDING COAL SLAG) OR ALUMINUM OXIDE  SEE NOTES (28) & (78)	ONE COAT MIL-PRF-23236, TYPE VII, CLASS 5, 4 - 8 MILS		ONE FULL COAT MIL-PRF-23236, TYPE VII, CLASS 5, 10 - 12 MILS	ONE FULL COAT HAZE GRAY OR LIGHT GRAY MIL-PRF-23236, TYPE VII, CLASS 5, 10 - 12 MILS		
INTERIOR ALUMINUM SURFACES	52	POWER TOOL CLEAN TO BARE METAL, SSPC-SP 11,  SEE NOTES (28) & (89)	2 COATS FORMULA 84, TT-P-645, ALKYD, 2 - 4 MILS/COAT - OR - ONE COAT MIL-PRF-23236, TYPE V VI, OR VII, CLASS 5 OR 7, 4 - 8 MILS --OR-- ONE COAT MIL-PRF-32584, TYPES I OR II, 10 - 12 MILS  SEE NOTE (88) & (93)		2 COATS MIL-DTL-24607, 2 - 4 MILS/COAT - OR - 2 COATS MIL-PRF-24596, WATER-BASED INTERIOR LATEX, 2 - 4 MILS/COAT  SEE NOTE (9)	TO DECKS NOT RECEIVING COVERING:  ONE COAT MIL-PRF-32584, TYPES I OR II, 10 - 12 MILS  SEE NOTE (88)	HULL, VENTILATION & PIPING INSULATION  ONE COAT MIL-DTL-24607, 2 - 4 MILS - OR - ONE COAT MIL-PRF-24596, WATER-BASED INTERIOR LATEX, 2 - 4 MILS  IF REQUIRED FOR HIDING, ONE ADDITIONAL COAT MUST BE APPLIED.  SEE NOTES (9), (28), (41) & (94)	FOR COMPARTMENT PIPING & VENTILATION  SEE NOTE (18) & (94)
	53	THOROUGH ABRASIVE CLEANING OF NON-FERROUS METALS, SSPC-SP 17 USING MIL-A-22262 QUALIFIED MEDIA (EXCLUDING COAL SLAG) OR ALUMINUM OXIDE SEE NOTES (28) & (78)	2 COATS FORMULA 84, TT-P-645, ALKYD, 2 - 4 MILS/COAT - OR - ONE COAT MIL-PRF-23236, TYPE V VI, OR VII, CLASS 5 OR 7, 4 - 8 MILS --OR-- ONE COAT MIL-PRF-32584, TYPES I OR II, 10 - 12 MILS  SEE NOTE (88) & (93)		2 COATS MIL-DTL-24607, 2 - 4 MILS/COAT - OR - 2 COATS MIL-PRF-24596, WATER-BASED INTERIOR LATEX, 2 - 4 MILS/COAT  SEE NOTE (9)	TO DECKS NOT RECEIVING COVERING:  ONE COAT MIL-PRF-32584, TYPES I OR II, 10 - 12 MILS  SEE NOTE (88)	HULL, VENTILATION & PIPING INSULATION  ONE COAT MIL-DTL-24607, 2 - 4 MILS - OR - ONE COAT MIL-PRF-24596, WATER-BASED INTERIOR LATEX, 2 - 4 MILS  IF REQUIRED FOR HIDING, ONE ADDITIONAL COAT MUST BE APPLIED.  SEE NOTES (9), (28), (41) & (94)	FOR COMPARTMENT PIPING & VENTILATION  SEE NOTE (18) & (94)

TABLE 3 ALUMINUM SURFACES  SURFACE SHIPS	LINE	A SURFACE PREPARATION	B PRIMER	C	D BULKHEADS & OVERHEADS	E DECKS	F INSULATION	G MARKINGS
	54	WATERJETTING TO NACE/SSPC-SP WJ-2 - OR - THOROUGH ABRASIVE BLAST CLEANING OF NON-FERROUS METALS, SSPC-SP 17 USING MIL-A- 22262 QUALIFIED MEDIA (EXCLUDING COAL SLAG) OR ALUMINUM OXIDE  SEE NOTES (90)	2 COATS FORMULA 84, TT-P-645, ALKYD, 2 - 4 MILS/COAT - OR - ONE COAT MIL-PRF-23236, TYPE V VI, OR VII, CLASS 5 OR 7, 4 - 8 MILS --OR-- ONE COAT MIL-PRF-32584, TYPES I OR II, 10 - 12 MILS  SEE NOTE (88) & (93)		2 COATS MIL-DTL-24607, 2 - 4 MILS/COAT - OR - 2 COATS MIL-PRF-24596, WATER-BASED INTERIOR LATEX, 2 - 4 MILS/COAT  SEE NOTE (9)	TO DECKS NOT RECEIVING COVERING:  ONE COAT MIL-PRF-32584, TYPES I OR II, 10 - 12 MILS  SEE NOTE (88)	HULL, VENTILATION & PIPING INSULATION  ONE COAT MIL-DTL-24607, 2 - 4 MILS - OR - ONE COAT MIL-PRF-24596, WATER-BASED INTERIOR LATEX, 2 - 4 MILS  IF REQUIRED FOR HIDING, ONE ADDITIONAL COAT MUST BE APPLIED.  SEE NOTES (9), (28), (41) & (94)	FOR COMPARTMENT PIPING & VENTILATION          SEE NOTE (18) & (94)

TABLE 3 GRP FIBERGLASS SURFACES  SURFACE SHIPS	LINE	A SURFACE PREPARATION	B PRIMER	C WELDING BAYS & LIGHT TRAPS	D BULKHEADS & OVERHEADS	E DECKS	F INSULATION	G MARKINGS
INTERIOR FIBROUS GLASS BOARDS	55	SOAP & WATER CLEAN & HAND SAND AS NECESSARY	ONE COAT FORMULA 84, TT-P- 645, ALKYD, 2 - 4 MILS  SEE NOTE (93)		2 COATS WATER-BASED INTERIOR LATEX, MIL-PRF- 24596, 2 - 4 MILS/COAT			
	56	SOAP & WATER CLEAN & HAND SAND AS NECESSARY	ONE COAT FORMULA 84, TT-P- 645, ALKYD, 2 - 4 MILS  SEE NOTE (93)		2 COATS OF FINISH COAT MIL-DTL-24607, 2 - 4 MILS/COAT, F-124, 125, OR 126 (COLOR TO BE DESIGNATED)			

TABLE 3 WOOD SURFACES  SURFACE SHIPS	LINE	A SURFACE PREPARATION	B PRIMER	C WELDING BAYS & LIGHT TRAPS	D BULKHEADS & OVERHEADS	E DECKS	F INSULATION	G MARKINGS
INTERIOR COMPARTMENTS  SEE NOTE (17)	57	HAND TOOL CLEAN -- & -- POWER TOOL CLEAN TO BARE WOOD OR TIGHTLY ADHERING INTACT PAINT	2 COATS FORMULA 84, ALKYD, TT-P-645, 2 - 4 MILS/COAT - OR - ONE COAT MIL-DTL-24441 TYPE IV, 2 - 4 MILS  SEE NOTE (93)		2 COATS MIL-PRF-24596, WATER-BASED INTERIOR LATEX, 2 - 4 MILS/COAT  SEE NOTE (9)	ONE COAT MIL-DTL-24441 TYPE IV, 2 - 4 MILS		FOR COMPARTMENT PIPING & VENTILATION  SEE NOTE (18)
	58	HAND TOOL CLEAN -- & -- POWER TOOL CLEAN TO BARE WOOD OR TIGHTLY ADHERING INTACT PAINT	2 COATS FORMULA 84, ALKYD, TT-P-645, 2 - 4 MILS/COAT - OR - ONE COAT MIL-DTL-24441 TYPE IV, 2 - 4 MILS  SEE NOTE (93)		2 COATS MIL-DTL-24607, 2 - 4 MILS/COAT	ONE COAT MIL-DTL-24441 TYPE IV, 2 - 4 MILS		FOR COMPARTMENT PIPING & VENTILATION  SEE NOTE (18)

TABLE 4 STEEL SURFACES  SURFACE SHIPS	LINE	A SURFACE PREPARATION	B	C	D	E	F	G TOTAL SYSTEM  SEE NOTE (53)
AIRCRAFT CARRIER POTABLE WATER TANKS  SEE NOTE (26)	1	NEAR WHITE METAL BLAST, NACE 2/SSPC-SP 10	ONE COAT F-150, MIL-DTL-24441, TYPE III, 2 - 4 MILS	ONE STRIPE COAT MIL-DTL-24441, TYPE III, 2 - 4 MILS	ONE COAT MIL-DTL-24441, TYPE III, 2 - 4 MILS	ONE STRIPE COAT MIL-DTL-24441, TYPE III, 2 - 4 MILS	ONE COAT MIL-DTL-24441, TYPE III, F-152, 2 - 4 MILS AT ADEQUATE THICKNESS TO MEET COATING RANGE	TOTAL SYSTEM 8 MILS MIN, 12 MILS MAX (AREAS WITHOUT STRIPE COAT)  SEE NOTE (37)
	2	NEAR WHITE METAL BLAST, NACE 2/SSPC-SP 10	ONE COAT MIL-PRF-23236, TYPE VII, CLASS 9, 4 - 8 MILS  SEE NOTES (55), (58), & (73)		ONE COAT MIL-PRF-23236, TYPE VII, CLASS 9, 10 - 12 MILS WHITE OR OFF-WHITE  SEE NOTES (55) & (73)			
	3	NEAR WHITE METAL BLAST, NACE 2/SSPC-SP 10	"SINGLE COAT"  ONE COAT MIL-PRF-23236 TYPE VII CLASS 9/18, 20-30 MILS WHITE OR OFF-WHITE  SEE NOTES (24), (55), & (58)					
NON-AIRCRAFT CARRIER POTABLE WATER TANKS  SEE NOTES (26) & (54)	4	NEAR WHITE METAL BLAST, NACE 2/SSPC-SP 10	ONE COAT MIL-PRF-23236, TYPE VII, CLASS 9, 4 - 8 MILS  SEE NOTES (55) & (58)		ONE COAT MIL-PRF-23236, TYPE VII, CLASS 9, 10 - 12 MILS WHITE OR OFF-WHITE  SEE NOTE (55)			
	5	NEAR WHITE METAL BLAST, NACE 2/SSPC-SP 10	"SINGLE COAT"  ONE COAT MIL-PRF-23236 TYPE VII CLASS 9/18, 20-30 MILS WHITE OR OFF-WHITE  SEE NOTES (24), (55), & (58)					
AIRCRAFT CARRIER RESERVE FEEDWATER TANKS AND FRESH WATER DRAIN COLLECTING TANKS  SEE NOTE (26)	6	NEAR WHITE METAL BLAST, NACE 2/SSPC-SP 10	ONE COAT F-150, MIL-DTL-24441, TYPE III, 2 - 4 MILS	ONE STRIPE COAT MIL-DTL-24441, TYPE III, 2 - 4 MILS	ONE COAT MIL-DTL-24441, TYPE III, 2 - 4 MILS	ONE STRIPE COAT MIL-DTL-24441, TYPE III, 2 - 4 MILS	ONE COAT MIL-DTL-24441, TYPE III, 2 - 4 MILS AT ADEQUATE THICKNESS TO MEET COATING RANGE	TOTAL SYSTEM 8 MILS MIN, 12 MILS MAX (AREAS WITHOUT STRIPE COAT)

TABLE 4 STEEL SURFACES  SURFACE SHIPS	LINE	A SURFACE PREPARATION	B	C	D	E	F	G TOTAL SYSTEM  SEE NOTE (53)
NON-AIRCRAFT CARRIER RESERVE FEEDWATER TANKS AND FRESHWATER DRAIN COLLECTING TANKS  SEE NOTES (26) & (54)	7	NEAR WHITE METAL BLAST, NACE 2/SSPC-SP 10	ONE COAT F-150, MIL-DTL-24441, TYPE III, 2 - 4 MILS	ONE STRIPE COAT MIL-DTL-24441, TYPE III, 2 - 4 MILS	ONE COAT MIL-DTL-24441, TYPE III, 2 - 4 MILS	ONE STRIPE COAT MIL-DTL-24441, TYPE III, 2 - 4 MILS	ONE COAT MIL-DTL- 24441, TYPE III, 2 - 4 MILS AT ADEQUATE THICKNESS TO MEET COATING RANGE	TOTAL SYSTEM 8 MILS MIN, 12 MILS MAX (AREAS WITHOUT STRIPE COAT)
	8	NEAR WHITE METAL BLAST, NACE 2/SSPC-SP 10	ONE COAT MIL-PRF-23236, TYPE VII, CLASS 11, 4 - 8 MILS  SEE NOTES (55) & (58)		ONE COAT MIL-PRF-23236, TYPE VII, CLASS 11, 10 - 12 MILS  SEE NOTE (55)			
	9	NEAR WHITE METAL BLAST, NACE 2/SSPC-SP 10	"SINGLE COAT"  ONE COAT MIL-PRF-23236 TYPE VII CLASS 11/18, 20-30 MILS  SEE NOTES (24) (55), & (58)					
JET PROPULSION FUEL (JP-5) TANKS, MOGAS TANKS, CONTAMINATED FUEL TANKS, DDG 51 AND LHD CLASS FUEL SERVICE TANKS, FUEL STORAGE COMP TANKS, SUMPS, DIRTY DRAIN COLLECTING TANKS, BILGE & OILY WASTE TANKS  15-20 YEARS SERVICE LIFE  SEE NOTES (26) & (65)	10	NEAR WHITE METAL BLAST, NACE 2/SSPC-SP 10	ONE COAT MIL-PRF-23236, TYPE VII, CLASS 5, 4 - 8 MILS  SEE NOTES (58), & (84)		ONE COAT MIL-PRF-23236, TYPE VII, CLASS 5, 10 - 12 MILS  SEE NOTE (84)			
	11	NEAR WHITE METAL BLAST, NACE 2/SSPC-SP 10	"SINGLE COAT"  ONE COAT MIL-PRF-23236 TYPE VII CLASS 5/18, 20-30 MILS  SEE NOTES (24), (58), & (84)					
JP-5 TANKS, MOGAS TANKS, CONTAMINATED FUEL TANKS, DDG 51 CLASS FUEL SERVICE TANKS, FUEL STORAGE COMP TANKS, SUMPS, DIRTY DRAIN	12	NEAR WHITE METAL BLAST, NACE 2/SSPC-SP 10	ONE COAT MIL-PRF-23236, TYPE VII, CLASS 5, 4 - 8 MILS  SEE NOTES (58), & (84)		ONE COAT MIL-PRF-23236, TYPE VII, CLASS 5, 10 - 12 MILS  SEE NOTE (84)			



TABLE 4 STEEL SURFACES  SURFACE SHIPS	LINE	A SURFACE PREPARATION	B	C	D	E	F	G TOTAL SYSTEM  SEE NOTE (53)
COLLECTING TANKS, BILGE & OILY WASTE TANKS  10-12 YEARS SERVICE LIFE  SEE NOTES (65) & (38)	13	NEAR WHITE METAL BLAST, NACE 2/SSPC-SP 10	"SINGLE COAT"  ONE COAT MIL-PRF-23236 TYPE VII CLASS 5/18, 20-30 MILS  SEE NOTES (24), (58), & (84)					
INTENTIONALLY LEFT BLANK	14	INTENTIONALLY LEFT BLANK	INTENTIONALLY LEFT BLANK					
COLLECTION, HOLDING AND TRANSFER (CHT), VACUUM COLLECTION (VC) / MARINE SANITATION DEVICE (MSD)/ LAUNDRY DRAIN COLLECTION TANKS  SEE NOTE (26)	15	NEAR WHITE METAL BLAST, NACE 2/SSPC-SP 10	ONE COAT MIL-PRF-23236, TYPE VII, CLASS 13, 4 - 8 MILS  SEE NOTE (58)		ONE COAT MIL-PRF-23236, TYPE VII, CLASS 13, 10 - 12 MILS			
	16	NEAR WHITE METAL BLAST, NACE 2/SSPC-SP 10	"SINGLE COAT"  ONE COAT MIL-PRF-23236, TYPE VII CLASS 13/18, 20-30 MILS  SEE NOTES (24), & (58)					
BALLAST TANKS, FLOODABLE VOIDS  EDGE RETENTIVE-EXTENDED SERVICE LIFE 15-20 YEARS (MORE STRINGENT HUMIDITY REQUIREMENTS)  SEE NOTE (26)	17	NEAR WHITE METAL BLAST, NACE 2/SSPC-SP 10	"SINGLE COAT"  ONE COAT MIL-PRF-23236 TYPE VII CLASS 7/18, 20-30 MILS  SEE NOTES (24), (58), & (84)					
BALLAST TANKS, FLOODABLE VOIDS  EDGE RETENTIVE SERVICE LIFE 10 - 12 YEARS (LESS STRINGENT HUMIDITY REQUIREMENTS)  SEE NOTE (38)	18	NEAR WHITE METAL BLAST, NACE 2/SSPC-SP 10	"SINGLE COAT"  ONE COAT MIL-PRF-23236 TYPE VII CLASS 7/18, 20-30 MILS  SEE NOTES (24), (58), & (84)					

TABLE 4 STEEL SURFACES  SURFACE SHIPS	LINE	A SURFACE PREPARATION	B	C	D	E	F	G TOTAL SYSTEM  SEE NOTE (53)
BALLAST TANKS, FLOODABLE VOIDS UP TO 10 YEARS SERVICE LIFE  SEE NOTE (38)	19	THOROUGH SPOT AND SWEEP BLAST CLEANING, SSPC-SP 18  SEE NOTE (67)	"SINGLE COAT" ONE COAT MIL-PRF-23236 TYPE VII, CLASS 7/18, 20-60 MILS  SEE NOTE (24)					
PEAK TANKS  EDGE RETENTIVE-EXTENDED SERVICE LIFE 15-20 YEARS (MORE STRINGENT HUMIDITY REQUIREMENTS)  SEE NOTE (26)	20	NEAR WHITE METAL BLAST, NACE 2/SSPC-SP 10	ONE COAT MIL-PRF-23236, TYPE VII CLASS 7, 4 - 8 MILS  SEE NOTE (58)		ONE COAT MIL-PRF-23236, TYPE VII CLASS 7, 10 - 12 MILS			
	21	NEAR WHITE METAL BLAST, NACE 2/SSPC-SP 10	"SINGLE COAT"  ONE COAT MIL-PRF-23236 TYPE VII CLASS 7/18, 20-30 MILS  SEE NOTES (24), (58), & (84)					
PEAK TANKS  EDGE RETENTIVE SERVICE LIFE 10 - 12 YEARS (LESS STRINGENT HUMIDITY REQUIREMENTS)  SEE NOTE (38)	22	NEAR WHITE METAL BLAST, NACE 2/SSPC-SP 10	ONE COAT MIL-PRF-23236, TYPE VII CLASS 7, 4 - 8 MILS  SEE NOTE (58)		ONE COAT MIL-PRF-23236, TYPE VII CLASS 7, 10 - 12 MILS			
	23	NEAR WHITE METAL BLAST, NACE 2/SSPC-SP 10	"SINGLE COAT"  ONE COAT MIL-PRF-23236 TYPE VII CLASS 7/18, 20-30 MILS  SEE NOTES (24), (58), & (84)					

TABLE 4 STEEL SURFACES  SURFACE SHIPS	LINE	A SURFACE PREPARATION	B	C	D	E	F	G TOTAL SYSTEM  SEE NOTE (53)
CHAIN LOCKERS AND NON-FLOODABLE VOIDS  SEE NOTE (38)	24	NEAR WHITE METAL BLAST, NACE 2/SSPC-SP 10	"SINGLE COAT"  ONE COAT MIL-PRF-23236, TYPE VII, CLASS 7/18, 20-30 MILS  SEE NOTES (24), & (58)					
	24A	THOROUGH SPOT AND SWEEP BLAST CLEANING, SSPC-SP 18  SEE NOTE (67)	"SINGLE COAT" ONE COAT MIL-PRF-23236 TYPE VII, CLASS 7/18, 20-60 MILS  SEE NOTES (24) & (58)					
	25	NEAR WHITE METAL BLAST, NACE 2/SSPC-SP 10	ONE COAT MIL-PRF-23236, TYPE VII, CLASS 5 OR 7, GRADE A OR B, 4 - 8 MILS  SEE NOTES (58) & (84)		ONE COAT MIL-PRF-23236, TYPE VII CLASS 5 OR 7, GRADE A OR B, 4 - 8 MILS  SEE NOTES (58), & (84)			
CVN CATAPULT WATER BRAKE TANKS	26	NEAR WHITE METAL BLAST, NACE 2/SSPC-SP 10	ONE COAT INORGANIC ZINC SILICATE TYPE COATING 2-4 MILS  SEE NOTE (51)					

TABLE 4 ALUMINUM SURFACES  SURFACE SHIPS	LINE	A SURFACE PREPARATION	B	C	D	E	F	G TOTAL SYSTEM  SEE NOTE (53)
POTABLE WATER TANKS AND STRUCTURAL WATER MIST FIRE EXTINGUISHING STORAGE TANKS	27	THOROUGH ABRASIVE BLAST CLEANING OF NON-FERROUS METALS, SSPC-SP 17 USING MIL-A- 22262 QUALIFIED MEDIA (EXCLUDING COAL SLAG) OR ALUMINUM OXIDE	SAME AS STEEL FOR SPECIFIED SERVICE	SAME AS STEEL FOR SPECIFIED SERVICE	SAME AS STEEL FOR SPECIFIED SERVICE	SAME AS STEEL FOR SPECIFIED SERVICE	SAME AS STEEL FOR SPECIFIED SERVICE	SAME AS STEEL FOR SPECIFIED SERVICE
LCS 2 CLASS FUEL SERVICE AND STORAGE TANKS, JP-5 TANKS  SEE NOTE (26)	28	THOROUGH ABRASIVE BLAST CLEANING OF NON-FERROUS METALS, SSPC-SP 17 USING MIL-A- 22262 QUALIFIED MEDIA (EXCLUDING COAL SLAG) OR ALUMINUM OXIDE	ONE COAT MIL-PRF-23236, TYPE VII, CLASS 5, 4 - 8 MILS  SEE NOTE (58)		ONE COAT MIL-PRF-23236, TYPE VII, CLASS 5, 10 - 12 MILS			
	29	THOROUGH ABRASIVE BLAST CLEANING OF NON-FERROUS METALS, SSPC-SP 17 USING MIL-A- 22262 QUALIFIED MEDIA (EXCLUDING COAL SLAG) OR ALUMINUM OXIDE	"SINGLE COAT"  ONE COAT MIL-PRF-23236 TYPE VII CLASS 5/18, 20-30 MILS  SEE NOTES (24), & (58)					

TABLE 5 VARIOUS LOCATIONS  SURFACE SHIPS	LINE	A SURFACE PREPARATION	B	C	D	E	F TOTAL SYSTEM  SEE NOTE (53)	G DESIGNATIONS & MARKINGS
EXISTING UNHEATED PIPING, FITTINGS, AND VALVES	1	HAND TOOL CLEAN, SSPC-SP 2	COAT TO MATCH SURROUNDING AREA  SEE NOTE (93)					ONE COAT MIL-PRF-24635, 5 - 8 MILS, FOR COLOR CODED SYSTEMS
MACHINERY, GAUGEBOARDS; UNHEATED FERROUS MACHINERY EXTERNAL SURFACES	2	POWER TOOL CLEAN, SSPC-SP 3	2 COATS F-84, ALKYD TT-P-645, 2-4 MILS/COAT  SEE NOTE (93)	ONE COAT F-111, MIL-DTL-15090, 2 - 4 MILS - OR - ONE COAT GRAY MIL- PRF-24635, TYPE V, 5 - 8 MILS  SEE NOTE (86)	IF REQUIRED FOR HIDING, ONE ADDITIONAL COAT: F-111, MIL-DTL-15090, 2 - 4 MILS - OR - MIL-PRF-24635, TYPE V, 5 - 8 MILS  SEE NOTE (86)			
UNINSULATED SIDE OF BULKHEAD OR SHELL ADJACENT TO SEA OR AC BOUNDARY (FOR INTERIOR COMPARTMENTS ONLY)	3	POWER TOOL CLEAN TO BARE METAL, SSPC-SP 11	ONE COAT HEMPEL HEMPADUR 45880, 4 - 6 MILS - OR - ONE COAT F-84, ALKYD, TT-P-645, 2 - 4 MILS - OR - ONE COAT MIL-PRF- 23236, TYPE V, VI, OR VII, CLASS 5 OR 7, 4 - 8 MILS	ONE COAT HEMPEL ANTI-CONDENS 617US-10000, 50 - 60 MILS - OR - ONE COAT KEFA AIRLESS 8125, 50 - 60 MILS				
	4	POWER TOOL CLEAN TO BARE METAL, SSPC-SP 11	ONE COAT F-84, ALKYD, TT-P-645, 2 - 4 MILS - OR - ONE COAT MIL-PRF- 23236, TYPE V, VI, OR VII, CLASS 5 OR 7, 4 - 8 MILS	ONE COAT TEMP-COAT 101, 20 - 22 MILS - OR - ONE COAT SHERWIN- WILLIAMS HEAT FLEX 3500, 20 - 22 MILS - OR - ONE COAT MASCOAT DELTA-T MARINE, 20-22 MILS	ONE COAT TEMP-COAT 101, 20 - 22 MILS - OR - ONE COAT SHERWIN- WILLIAMS HEAT FLEX 3500, 20 - 22 MILS - OR - ONE COAT MASCOAT DELTA-T MARINE, 20-22 MILS	ONE COAT TEMP-COAT 101, 20 - 22 MILS - OR - ONE COAT SHERWIN- WILLIAMS HEAT FLEX 3500, 20 - 22 MILS - OR - ONE COAT MASCOAT DELTA-T MARINE, 20-22 MILS		

TABLE 5 VARIOUS LOCATIONS  SURFACE SHIPS	LINE	A SURFACE PREPARATION	B	C	D	E	F TOTAL SYSTEM  SEE NOTE (53)	G DESIGNATIONS & MARKINGS
	4A	POWER TOOL CLEAN TO BARE METAL, SSPC-SP 11	ONE COAT F-84, ALKYD, TT-P-645, 2 - 4 MILS - OR - ONE COAT MIL-PRF-23236, TYPE V, VI, OR VII. CLASS 5 OR 7, 4 - 8 MILS	ONE COAT TNEMEC AEROLON SERIES 971 OR 972, 30-50 MILS	ONE COAT TNEMEC AEROLON SERIES 971 OR 972, 30-50 MILS	ONE COAT TNEMEC AEROLON SERIES 971 OR 972, 30-50 MILS		
BOILERS & ECONOMIZERS (EXCEPT PARTS USED FOR HEAT TRANSFER), MACHINERY CASINGS, FERROUS SHEET METAL	5	POWER TOOL CLEAN TO BARE METAL, SSPC-SP 11	ONE COAT PSX 892HS, 2 - 3 MILS  SEE NOTE (39)					
	6	POWER TOOL CLEAN TO BARE METAL, SSPC-SP 11	2 COATS OF TT-P-28 SUFFICIENT TO COVER THE PROFILE					
STEAM, RESERVE FEEDWATER, BOTTOM/ SURFACE BLOW & BOILER PRESSURE VESSEL PIPING IN PREPARATION FOR ULTRASONIC MEASUREMENTS	7	NEW PIPING: POWER TOOL CLEAN TO BARE METAL, SSPC-SP 11, USING STAINLESS STEEL WIRE BRUSHES, STAINLESS STEEL PADS, OR ABRASIVE SANDING DISCS (ANSI/BHMA B74.18). ABRASIVE BLASTING WHERE SPECIFIED MUST BE SSPC-SP 10 (FERROUS PIPING) OR SSPC-SP 16 (NON-FERROUS PIPING).  EXISTING PIPING: CLEAN TO BARE METAL USING HAND TOOLS, APPROVED CHEMICAL STRIPPERS, OR AN EMERY CLOTH FLAP WHEEL TOOL. ABRASIVE BLAST MUST BE LIMITED TO SSPC-SP 7 (FERROUS PIPING) OR SSPC-SP 16 (NON-FERROUS PIPING).						

TABLE 5 VARIOUS LOCATIONS  SURFACE SHIPS	LINE	A SURFACE PREPARATION	B	C	D	E	F TOTAL SYSTEM  SEE NOTE (53)	G DESIGNATIONS & MARKINGS
ELECTRICAL EQUIPMENT, ELECTRONIC EQUIPMENT	8	HAND TOOL CLEAN, SSPC-SP 2	2 COATS F-84, TT-P-645, ALKYD, 2 - 4 MILS/COAT  SEE NOTE (93)	2 COATS F-111, MIL-DTL- 15090, 2 - 4 MILS/COAT				
CABLE, INTERIOR	9	HAND TOOL CLEAN, SSPC-SP 2	ONE COAT WATER- BASED LATEX PER MIL- PRF-24596, 2 - 4 MILS/COAT --OR-- ONE COAT MIL-DTL- 24607 2 - 4 MILS/COAT  IF REQUIRED FOR HIDING, ONE ADDITIONAL COAT MUST BE APPLIED.					
	9A	HAND TOOL CLEAN, SSPC-SP 2	2 COATS FS1, 17-23 MILS/COAT  SEE NOTE (95)	2 COATS MIL-PRF-24596, 2- 4 MILS/COAT (FOR COLOR MATCH IF REQUIRED)				
CABLE, EXTERIOR (OTHER THAN POLYVINYL CHLORIDE (PVC), LOW SMOKE)	10	HAND TOOL CLEAN, SSPC-SP 2	2 COATS MIL-PRF-24763, TYPE II, CLASS 2, 2 - 4 MILS/COAT --OR-- ONE COAT MIL-PRF- 24635, TYPE V TO MATCH SURROUNDING AREA, 5 - 8 MILS  SEE NOTE (86)					
ANCHOR (SURFACE SHIP BOW ANCHORS)  FOR ANCHORS BELOW LOWER BOOTTOPPING LIMIT, SEE NOTE (13)	11	NEAR WHITE METAL BLAST, NACE 2/SSPC-SP 10  SEE NOTES (14) & (21)	ONE COAT MIL-PRF- 23236, TYPE V OR VI, CLASS 5 OR 7, 4 - 8 MILS - OR - ONE COAT MIL-PRF- 23236, CLASS 5 OR 7, TYPE VII, 4 - 8 MILS	ONE COAT MIL-PRF-23236, TYPE V OR VI, CLASS 5 OR 7, 4 - 8 MILS - OR - ONE COAT MIL-PRF-23236, TYPE VII, CLASS 5 OR 7, 10 - 12 MILS	ONE COAT HAZE GRAY, MIL-PRF-24635 TYPE V OR VI, CLASS 2, GRADE B OR C, 5 - 8 MILS  SEE NOTES (85) & (86)			

TABLE 5 VARIOUS LOCATIONS  SURFACE SHIPS	LINE	A SURFACE PREPARATION	B	C	D	E	F TOTAL SYSTEM  SEE NOTE (53)	G DESIGNATIONS & MARKINGS
ANCHOR CHAIN, STERN GATE CHAIN  SEE NOTE (15)	12	COMMERCIAL BLAST CLEAN, NACE 3/SSPC-SP 6  SEE NOTES (14) & (21)		ONE COAT MIL-PRF-24635, TYPE V OR VI, CLASS 1, GRADE A, 5 – 8 MILS --OR-- ONE COAT MIL-PRF-23236 TYPE VI OR VII, 4-8 MILS	ONE COAT MIL-PRF-24635, TYPE V OR VI, CLASS 1, GRADE A, 5 - 8 MILS			MIL-PRF-24635, TYPE V OR VI, CLASS 1, 5 – 8 MILS
INTERIOR GALVANIZED SURFACES	13	BRUSH-OFF BLAST, NACE 4/SSPC-SP 7 - OR - POWER TOOL CLEAN, SSPC-SP 3		ONE COAT WATER-BASED INTERIOR LATEX, MIL-PRF-24596, 2 - 4 MILS				
EXTERIOR GALVANIZED SURFACES	14	BRUSH-OFF BLAST, NACE 4/SSPC-SP 7 - OR - POWER TOOL CLEAN, SSPC-SP 3	ONE COAT MIL-PRF- 23236 TYPE V CLASS 5 OR 7 -OR- MIL-DTL-24441, 1 - 2 MILS	ONE COAT MIL-PRF-24763, 2 - 4 MILS --OR-- ONE COAT MIL-PRF-24635, TYPE V OR VI, CLASS 1, GRADE A, 5 – 8 MILS				



TABLE 5 VARIOUS LOCATIONS  SURFACE SHIPS	LINE	A SURFACE PREPARATION	B	C	D	E	F TOTAL SYSTEM  SEE NOTE (53)	G DESIGNATIONS & MARKINGS
EXHAUST PIPE EXTERIOR	15	<p>NEW PIPING: POWER TOOL CLEAN TO BARE METAL, SSPC-SP 11, USING STAINLESS STEEL WIRE BRUSHES, STAINLESS STEEL PADS, OR ABRASIVE SANDING DISCS (ANSI/BHMA B74.18). ABRASIVE BLASTING WHERE SPECIFIED MUST BE SSPC-SP 10 (FERROUS PIPING) OR SSPC-SP 16 (NON-FERROUS PIPING).</p> <p>EXISTING PIPING: CLEAN TO BARE METAL USING HAND TOOLS, APPROVED CHEMICAL STRIPPERS, OR AN EMERY CLOTH FLAP WHEEL TOOL. ABRASIVE BLAST MUST BE LIMITED TO SSPC-SP 7 (FERROUS PIPING) OR SSPC-SP 16 (NON-FERROUS PIPING).</p> <p>--OR-- BRUSH-OFF BLAST NACE 4/SSPC-SP 7</p> <p>--OR-- HAND TOOL CLEAN, SSPC-SP 2</p> <p>--OR-- POWER TOOL CLEAN, SSPC-SP 3</p>	<p>2 COATS HI-TEMP 1000, HAZE GRAY 1-2 MILS --OR-- ONE COAT PSX 892HS, HAZE GRAY, 2 - 3 MILS - OR - 2 COATS OF TT-P-28 SUFFICIENT TO COVER THE PROFILE</p> <p>SEE NOTES (39)</p>					
BLISS CAP	15A	<p>COMMERCIAL BLAST CLEAN, NACE 3/SSPC-SP 6</p> <p>SEE NOTES (14) &amp; (21)</p>	<p>2 COATS PPG HI-TEMP 1000, HAZE GRAY, 1-2 MILS</p>					

TABLE 5 VARIOUS LOCATIONS  SURFACE SHIPS	LINE	A SURFACE PREPARATION	B	C	D	E	F TOTAL SYSTEM  SEE NOTE (53)	G DESIGNATIONS & MARKINGS
ELEVATED TEMPERATURE PIPING AND MACHINERY, 125-250F	16	<p>NEW PIPING: POWER TOOL CLEAN TO BARE METAL, SSPC-SP 11, USING STAINLESS STEEL WIRE BRUSHES, STAINLESS STEEL PADS, OR ABRASIVE SANDING DISCS (ANSI/BHMA B74.18). ABRASIVE BLASTING WHERE SPECIFIED MUST BE SSPC-SP 10 (FERROUS PIPING) OR SSPC-SP 16 (NON-FERROUS PIPING).</p> <p>EXISTING PIPING: CLEAN TO BARE METAL USING HAND TOOLS, APPROVED CHEMICAL STRIPPERS, OR AN EMERY CLOTH FLAP WHEEL TOOL. ABRASIVE BLAST MUST BE LIMITED TO SSPC-SP 7 (FERROUS PIPING) OR SSPC-SP 16 (NON-FERROUS PIPING).</p> <p>--OR-- POWER TOOL CLEAN TO BARE METAL, SSPC-SP 11</p> <p>--OR-- BRUSH-OFF BLAST NACE 4/SSPC-SP 7</p> <p>--OR-- HAND TOOL CLEAN, SSPC-SP 2</p> <p>--OR-- POWER TOOL CLEAN, SSPC-SP 3</p>	ONE COAT MIL-DTL-24441 TYPE IV, 4-6 MILS					

TABLE 5 VARIOUS LOCATIONS  SURFACE SHIPS	LINE	A SURFACE PREPARATION	B	C	D	E	F TOTAL SYSTEM  SEE NOTE (53)	G DESIGNATIONS & MARKINGS
HIGH TEMPERATURE PIPING AND MACHINERY, 250-400F	17	<p>NEW PIPING: POWER TOOL CLEAN TO BARE METAL, SSPC-SP 11, USING STAINLESS STEEL WIRE BRUSHES, STAINLESS STEEL PADS, OR ABRASIVE SANDING DISCS (ANSI/BHMA B74.18). ABRASIVE BLASTING WHERE SPECIFIED MUST BE SSPC-SP 10 (FERROUS PIPING) OR SSPC-SP 16 (NON-FERROUS PIPING).</p> <p>EXISTING PIPING: CLEAN TO BARE METAL USING HAND TOOLS, APPROVED CHEMICAL STRIPPERS, OR AN EMERY CLOTH FLAP WHEEL TOOL. ABRASIVE BLAST MUST BE LIMITED TO SSPC-SP 7 (FERROUS PIPING) OR SSPC-SP 16 (NON-FERROUS PIPING).</p> <p>--OR-- POWER TOOL CLEAN TO BARE METAL, SSPC-SP 11</p> <p>--OR-- BRUSH-OFF BLAST NACE 4/SSPC-SP 7</p> <p>--OR-- HAND TOOL CLEAN, SSPC-SP 2</p> <p>--OR-- POWER TOOL CLEAN, SSPC-SP 3</p>	<p>ONE COAT PSX 892HS, HAZE GRAY, 2 - 3 MILS</p> <p>SEE NOTE (39)</p>					

TABLE 5 VARIOUS LOCATIONS  SURFACE SHIPS	LINE	A SURFACE PREPARATION	B	C	D	E	F TOTAL SYSTEM  SEE NOTE (53)	G DESIGNATIONS & MARKINGS
HIGH TEMPERATURE PIPING AND MACHINERY, 400-1200F	18	<p>NEW PIPING: POWER TOOL CLEAN TO BARE METAL, SSPC-SP 11, USING STAINLESS STEEL WIRE BRUSHES, STAINLESS STEEL PADS, OR ABRASIVE SANDING DISCS (ANSI/BHMA B74.18). ABRASIVE BLAST TO SSPC-SP 10 (FERROUS PIPING) OR SSPC-SP 16 (NON-FERROUS PIPING).</p> <p>EXISTING PIPING: CLEAN TO BARE METAL USING HAND TOOLS, OR AN EMERY CLOTH FLAP WHEEL TOOL. ABRASIVE BLAST TO SSPC-SP 7 (FERROUS PIPING) OR SSPC-SP 16 (NON-FERROUS PIPING) OR HAND TOOL CLEAN TO SSPC-SP 2 OR POWER TOOL CLEAN TO SSPC-SP 3.</p>	2 COATS OF TT-P-28 SUFFICIENT TO COVER THE PROFILE					
ARRESTING GEAR SHEAVE FOUNDATIONS (OUTBOARD OF ARRESTING GEAR ENGINE ROOMS)	19	<p>SOLVENT CLEAN, SSPC-SP 1 -- &amp; -- SPONGE BLAST TO NEAR WHITE METAL BLAST, NACE 2/SSPC-SP 10 -- &amp; -- SOLVENT CLEAN, SSPC-SP 1 (STEAM CLEAN) -- &amp; -- SPONGE BLAST TO NEAR WHITE METAL BLAST, NACE 2/SSPC-SP 10</p>	ONE COAT MIL-PRF-23236, TYPE VII, CLASS 5, 4 - 8 MILS		ONE COAT MIL-PRF-23236, TYPE VII, CLASS 5, 10 - 12 MILS			

TABLE 5 VARIOUS LOCATIONS  SURFACE SHIPS	LINE	A SURFACE PREPARATION	B	C	D	E	F TOTAL SYSTEM  SEE NOTE (53)	G DESIGNATIONS & MARKINGS
	20	SOLVENT CLEAN, SSPC-SP 1 -- & -- SPONGE BLAST TO NEAR WHITE METAL BLAST, NACE 2/SSPC-SP 10 -- & -- SOLVENT CLEAN, SSPC-SP 1 (STEAM CLEAN) -- & -- SPONGE BLAST TO NEAR WHITE METAL BLAST, NACE 2/SSPC-SP 10	ONE COAT MIL-PRF- 23236, TYPE VII CLASS 17, 6 – 8 MILS		ONE FULL COAT MIL-PRF- 23236 TYPE VII, CLASS 17, 6 – 8 MILS			
	21	SOLVENT CLEAN, SSPC-SP 1 -- & -- SPONGE BLAST TO NEAR WHITE METAL BLAST, NACE 2/SSPC-SP 10 -- & -- SOLVENT CLEAN, SSPC-SP 1 (STEAM CLEAN) -- & -- SPONGE BLAST TO NEAR WHITE METAL BLAST, NACE 2/SSPC-SP 10	"SINGLE COAT"  ONE COAT MIL-PRF- 23236 TYPE VII CLASS 17/18, 20-30 MILS  SEE NOTE (24)					
ARRESTING GEAR SHEAVE FOUNDATIONS (ARRESTING GEAR ENGINE ROOMS)	22	POWER TOOL CLEAN TO BARE METAL, SSPC-SP 11	ONE COAT MIL-PRF- 23236, TYPE VI, CLASS 5 OR 7, 4-8 MILS	ONE STRIPE COAT MIL- PRF-23236, TYPE VI, CLASS 5 OR 7, 4-8 MILS	ONE COAT MIL-PRF-23236, TYPE VI, CLASS 5 OR 7, 4-8 MILS			
POWDER COATING FOR EXTERIOR APPLICATIONS AND INTERIOR DRY APPLICATIONS OF REMOVABLE PARTS	23	NEAR WHITE METAL BLAST, NACE 2/SSPC-SP 10  SEE NOTES (14) & (21)	ONE COAT MIL-PRF- 24712, 2-9 MILS					
POWDER COATING FOR INTERIOR WET OR IMMERSION APPLICATION AREAS	24	NEAR WHITE METAL BLAST, NACE 2/SSPC-SP 10  SEE NOTES (14) & (21)	ONE COAT MIL-PRF- 23236, TYPE VIII, 2-9 MILS					

TABLE 5 VARIOUS LOCATIONS  SURFACE SHIPS	LINE	A SURFACE PREPARATION	B	C	D	E	F TOTAL SYSTEM  SEE NOTE (53)	G DESIGNATIONS & MARKINGS
CATAPULT WING VOIDS, CATAPULT EXHAUST BLOWDOWN TRUNKS, AND FREEING PORTS  SEE NOTE (38)	25	NEAR WHITE METAL BLAST, NACE 2/SSPC-SP 10  SEE NOTES (14) & (21)	ONE COAT MIL-PRF- 23236, TYPE VI, CLASS 5 OR 7, 4 - 8 MILS	ONE STRIPE COAT MIL- PRF-23236, TYPE VI, CLASS 5 OR 7, 4 - 8 MILS	ONE COAT MIL-PRF-23236, TYPE VI, CLASS 5 OR 7, 4 - 8 MILS			
BARRICADE STANCHIONS AND WELLS, CATAPULT JET BLAST DEFLECTOR PITS, AND ASSOCIATED VOID SPACES  SEE NOTE (44)	26	NEAR WHITE METAL BLAST, NACE 2/SSPC-SP 10  SEE NOTES (14) & (21)	ONE COAT MIL-PRF- 23236, TYPE VI, CLASS 5, 4 - 8 MILS	ONE STRIPE COAT MIL- PRF-23236, TYPE VI, CLASS 5, 4 - 8 MILS	ONE COAT MIL-PRF-23236, TYPE VI, CLASS 5, 4 - 8 MILS  SEE NOTE (35)			

TABLE 6 STEEL SURFACES  SUBMARINES	LINE	A SURFACE PREPARATION	B PRIMER	C	D	E KEEL TO MAX BEAM	F MAX BEAM TO UPPER BOOTTOP	G DRAFT MARKS
EXTERIOR SURFACES (KEEL TO UPPER BOOTTOP)  (NON-SHT SURFACES BELOW UPPER BOOTTOP)	1	NEAR WHITE METAL BLAST, NACE 2/SSPC-SP 10 - OR - WATERJETTING TO NACE/SSPC-SP WJ-2/L - OR - SSPC-SP 10/L (WAB)/NACE WAB-2/L	ONE COAT MIL- PRF-23236, TYPE V OR VI CLASS 5 OR 7, 4 - 8 MILS --OR-- ONE AC COATS MIL-PRF- 24647 TYPE I OR II, 5 - 7 MILS --OR-- ONE COAT MIL-DTL-24441 TYPE IV, F-150, 4 - 6 MILS  SEE NOTES (1A), (4A), (35A) & (45A)	ONE STRIPE COAT MIL- PRF- 23236, TYPE V OR VI CLASS 5 OR 7, 4 - 8 MILS --OR-- ONE AC STRIPE COAT MIL- PRF-24647 TYPE I OR II, 5 - 7 MILS --OR-- ONE STRIPE COAT MIL-DTL- 24441 TYPE IV, 4 - 6 MILS  SEE NOTES (1A), (4A), (35A) & (45A)	ONE COAT MIL- PRF-23236, TYPE V OR VI CLASS 5 OR 7, 4 - 8 MILS --OR-- ONE AC COAT MIL-PRF- 24647 TYPE I OR II, 5 - 7 MILS --OR-- ONE COAT MIL-DTL-24441 TYPE IV, F-153, 4 - 6 MILS  SEE NOTES (1A), (4A), (35A) & (45A)	2 AF COATS MIL-PRF- 24647, TYPE I OR II, 5 - 7 MILS/COAT          SEE NOTES (2A),(4A) & (45A)	2 AF COATS MIL-PRF- 24647, TYPE I OR II BLACK, 5 - 7 MILS/COAT          SEE NOTES (3A), (4A) & (45A)	ONE COAT MIL-DTL-24631 F-186 --OR-- ONE COAT MIL-DTL-24441 TYPE IV, F-152 --OR-- ONE AC COAT MIL-PRF- 23236, WHITE, 3-4 MILS --OR-- COMMERCIAL GRADE WHITE AF
NON-SHT, EXTERIOR SURFACES ABOVE THE UPPER BOOTTOP (INCLUDES SUBMARINE RESCUE VEHICLE SEATING SURFACES)	2	NEAR WHITE METAL BLAST, NACE 2/SSPC-SP 10 - OR - WATERJETTING TO NACE/SSPC-SP WJ-2/L - OR - SSPC-SP 10/L (WAB)/NACE WAB-2/L	ONE COAT MIL- PRF-23236, TYPE V OR VI CLASS 5 OR 7, 4 - 8 MILS --OR-- ONE COAT AC MIL-PRF- 24647, TYPE I OR II, 5 - 7 MILS  SEE NOTES (1A), (35A) & (45A)	ONE STRIPE COAT MIL- PRF- 23236, TYPE V OR VI CLASS 5 OR 7, 4 - 8 MILS --OR-- ONE STRIPE COAT AC MIL- PRF-24647, TYPE I OR II, 5 - 7 MILS  SEE NOTES (1A), (35A) & (45A)	ONE COAT MIL- PRF-23236, TYPE V OR VI CLASS 5 OR 7, 4 - 8 MILS --OR-- ONE COAT AC MIL-PRF- 24647, TYPE I OR II, 5 - 7 MILS  FINAL COAT TO BE BLACK  SEE NOTES (1A), (32A), (35A) & (45A)			
	3	NEAR WHITE METAL BLAST, NACE 2/SSPC-SP 10 - OR - WATERJETTING TO NACE/SSPC-SP WJ-2/L - OR - SSPC-SP 10/L (WAB)/NACE WAB-2/L	ONE COAT MIL-DTL-24441 TYPE IV, F-150, 4 - 6 MILS  SEE NOTES (1A)& (35A)	ONE STRIPE COAT MIL-DTL- 24441 TYPE IV, 4 - 6 MILS  SEE NOTES (1A) & (35A)	ONE COAT MIL-DTL-24441 TYPE IV, F-153, 4 - 6 MILS  SEE NOTES (1A), (32A), & (35A)			

TABLE 6 STEEL SURFACES  SUBMARINES	LINE	A SURFACE PREPARATION	B PRIMER	C	D	E KEEL TO MAX BEAM	F MAX BEAM TO UPPER BOOTTOP	G DRAFT MARKS
FOR MOORED TRAINING SHIPS (MTS) ONLY; EXTERIOR SURFACES ABOVE THE UPPER BOOTTOP (NON-IMMERSION SURFACES ONLY)	4	NEAR WHITE METAL BLAST, NACE 2/SSPC-SP 10 - OR - WATERJETTING TO NACE/SSPC-SP WJ-2/L - OR - SSPC-SP 10/L (WAB)/NACE WAB-2/L	ONE COAT MIL-PRF-23236, TYPE V OR VI CLASS 5 OR 7, 4 - 8 MILS --OR-- ONE COAT MIL-DTL-24441, TYPE IV 4 - 6 MILS  SEE NOTES (1A) & (32A)	ONE STRIPE COAT MIL-PRF-23236, TYPE V OR VI CLASS 5 OR 7, 4 - 8 MILS --OR-- ONE STRIPE COAT MIL-DTL-24441, TYPE IV 4 - 6 MILS  SEE NOTES (1A) & (32A)	ONE COAT MIL-PRF-23236, TYPE V OR VI CLASS 5 OR 7, 4 - 8 MILS --OR-- ONE COAT MIL-DTL-24441, TYPE IV 4 - 6 MILS  SEE NOTES (1A) & (32A)	UPPER BOOTTOP TO TOP OF SAIL ONLY:  ONE COAT MIL-PRF-24635, 5 - 8 MILS -&- ONE COAT MIL-PRF-24667, TYPE I OR X, COMP G		
UNTILED (NON-SHT COVERED) FOOT TRAFFIC AREAS TO BE COVERED WITH NONSKID SYSTEM (ALL CLASSES OF SUBMARINES)	5	NEAR WHITE METAL BLAST, NACE 2/SSPC-SP 10 - OR - WATERJETTING TO NACE/SSPC-SP WJ-2/L - OR - SSPC-SP 10/L (WAB)/NACE WAB-2/L	ONE COAT MIL-DTL-24441 TYPE IV F-150, 4 - 6 MILS  SEE NOTES (1A) & (32A)	ONE STRIPE COAT MIL-DTL-24441 TYPE IV, 4 - 6 MILS  SEE NOTES (1A) & (32A)	ONE COAT PROPRIETARY NONSKID PRIMER LISTED ON THE QPL FOR MIL-PRF-24667 (OF TYPE TO MATCH COLUMN E)  SEE NOTES (1A) & (32A)	ONE COAT MIL-PRF-24667, TYPE X, COMP G  SEE NOTE (44A)		
	6	NEAR WHITE METAL BLAST, NACE 2/SSPC-SP 10 - OR - WATERJETTING TO NACE/SSPC-SP WJ-2/L - OR - SSPC-SP 10/L (WAB)/NACE WAB-2/L	ONE COAT MIL-PRF-23236, TYPE V OR VI CLASS 5 OR 7, 4 - 8 MILS --OR-- ONE COAT AC MIL-PRF-24647, TYPE I OR II, 5 - 7 MILS  SEE NOTES (1A), (32A), & (45A)	ONE STRIPE COAT MIL-PRF-23236, TYPE V OR VI CLASS 5 OR 7, 4 - 8 MILS --OR-- ONE STRIPE COAT AC MIL-PRF-24647, TYPE I OR II, 5 - 7 MILS  SEE NOTES (1A), (32A), & (45A)	ONE COAT PROPRIETARY NONSKID PRIMER LISTED ON THE QPL FOR MIL-PRF-24667 (OF TYPE TO MATCH COLUMN E)  SEE NOTES (1A) & (32A)	ONE COAT MIL-PRF-24667, TYPE X, COMP G  SEE NOTE (44A)		



TABLE 6 STEEL SURFACES  SUBMARINES	LINE	A SURFACE PREPARATION	B PRIMER	C	D	E KEEL TO MAX BEAM	F MAX BEAM TO UPPER BOOTTOP	G DRAFT MARKS
INTERIOR SURFACES OF RUDDERS, PLANES, STABILIZERS (SYNTACTIC FILLED VOIDS)	7	HAND TOOL CLEAN, SSPC-SP 2	2 COATS TT-P-645 F-84 (PRIMER), 1-2 MILS/COAT -OR- ONE COAT PRIMER MIL- PRF-23236, TYPE V OR VI, 4-6 MILS -OR- ONE COAT MIL-DTL-24441, TYPE IV, F-150, 4-6 MILS	ONE STRIPE COAT TT-P-645, 1-2 MILS -OR- ONE STRIPE COAT MIL-PRF-23236, TYPE V OR VI, 4-6 MILS -OR- ONE STRIPE COAT MIL-DTL-24441, TYPE IV, 4-6 MILS				

TABLE 6 GRP FIBERGLASS SURFACES  SUBMARINES	LINE	A SURFACE PREPARATION	B PRIMER	C	D	E KEEL TO MAX BEAM	F MAX BEAM TO UPPER BOOTTOP	G DRAFT MARKS
UNBOOTED GRP BOW DOMES ABOVE UPPER BOOTTOP  SEE NOTE (34A)	8	LOW PRESSURE WATER CLEAN          SEE NOTE (42A)	ONE COAT MIL-DTL-24441, TYPE IV, F-150, 4 - 6 MILS -- & -- ONE COAT MIL-DTL-24441 TYPE IV, F-153 OR F-154, 4 - 6 MILS --OR-- 2 COATS MIL-PRF-24647 4 - 6 MIL/COAT --OR-- 2 COATS MIL-PRF-23236 TYPE V OR VI, CLASS 5 OR 7, 4 - 6 MILS/COAT  SEE NOTES (32A), (38A), & (45A)					
UNBOOTED GRP BOW DOMES BELOW UPPER BOOTTOP  SEE NOTE (34A)	9	LOW PRESSURE WATER CLEAN          SEE NOTE (42A)	ONE COAT MIL-DTL-24441, TYPE IV, F-150, 4 - 6 MILS --OR-- ONE COAT MIL-PRF-24647 4 - 6 MIL/COAT DARK GRAY  SEE NOTES (4A) & (45A)			2 COATS AF MIL-PRF- 24647, TYPE I OR II CLASS 1, 4 - 6 MIL/COAT  SEE NOTES (2A), (4A), (38A), & (45A)	2 COATS AF MIL-PRF- 24647, TYPE I OR II CLASS 1, 4 - 6 MIL/COAT  SEE NOTES (3A), (4A), (38A), & (45A)	
BOOTED GRP BOW DOMES ABOVE UPPER BOOTTOP  SEE NOTE (34A)	10	LOW PRESSURE WATER CLEAN          SEE NOTE (43A)	PRIOR TO INSTALLING THE BOOT - ONE COAT MIL- DTL-24441, TYPE IV, F-150, 4-6 MILS  AFTER BOOT INSTALLATION ONE COAT NAVY FORMULA 187, 2-3 MILS  SEE NOTES (38A) & (46A)					

TABLE 6 GRP FIBERGLASS SURFACES  SUBMARINES	LINE	A SURFACE PREPARATION	B PRIMER	C	D	E KEEL TO MAX BEAM	F MAX BEAM TO UPPER BOOTTOP	G DRAFT MARKS
BOOTED GRP BOW DOMES, CHIN ARRAY, & LIGHT WEIGHT WIDE APERTURE ARRAY (LWWAA) BELOW UPPER BOOTTOP  SEE NOTE (34A)	11	LOW PRESSURE WATER CLEAN          SEE NOTE (43A)	PRIOR TO INSTALLING THE BOOT - ONE COAT MIL- DTL-24441, TYPE IV, F-150, 4-6 MILS  AFTER BOOT INSTALLATION ONE COAT NAVY FORMULA 184, 2-3 MILS			2 COATS AF MIL-PRF- 24647, TYPE I CLASS 3, 4 - 6 MIL/COAT       SEE NOTES (2A), (4A), & (38A), & (45A)	2 COATS AF MIL-PRF- 24647, TYPE I CLASS 3, 4 - 6 MIL/COAT       SEE NOTES (3A), (4A), & (38A), & (45A)	
GRP SURFACES ABOVE UPPER BOOTTOP	12	LOW PRESSURE WATER CLEAN          SEE NOTE (43A)	SAME AS LINE 8					
GRP SURFACES BELOW UPPER BOOTTOP	13	LOW PRESSURE WATER CLEAN          SEE NOTE (43A)	SAME AS LINE 9			SAME AS LINE 9	SAME AS LINE 9	

TABLE 7 STEEL SURFACES  SUBMARINES	LINE	A SURFACE PREPARATION	B PRIMER	C	D	E BULKHEADS AND OVERHEADS	F THERMAL INSULATION	G
BILGE AND TRUNK INTERIOR AREAS BELOW THE LOWER WALKING FLAT  SEE NOTE (36A)	1	POWER TOOL CLEAN TO BARE METAL, SSPC-SP 11  SEE NOTE (6A)	ONE COAT MIL-PRF-23236, TYPE VII, CLASS 17, 5 - 7 MILS  SEE NOTES (8A), (15A) & (28A)	ONE FULL COAT MIL-PRF- 23236, TYPE VII, CLASS 17, 5 - 7 MILS/COAT  SEE NOTES (7A), (8A), (9A), (15A), (28A), & (33A)				
	2	POWER TOOL CLEAN TO BARE METAL, SSPC-SP 11  SEE NOTE (6A)	ONE COAT MIL-DTL-24441, TYPE IV, F-150, 4-6 MILS  SEE NOTES (15A) & (28A)	ONE STRIPE COAT AND ONE FULL COAT MIL-DTL-24441, TYPE IV, F-151 OR F-157, 4-6 MILS/COAT  SEE NOTES (7A), (15A), (28A), & (33A)				
	3	POWER TOOL CLEAN TO BARE METAL, SSPC-SP 11  SEE NOTE (6A)	ONE COAT MIL- PRF-23236, TYPE V OR VI, CLASS 5 OR 7, 4 - 8 MILS  SEE NOTES (15A) & (28A)	ONE STRIPE COAT AND ONE FULL COAT MIL-PRF-23236, TYPE V OR VI, CLASS 5 OR 7, 4 - 8 MILS/COAT  SEE NOTES (7A), (9A), (15A), (28A), & (33A)				
WET SPACES (EXCEPT BILGES AND TRUNKS)	4	POWER TOOL CLEAN TO BARE METAL, SSPC-SP 11  SEE NOTE (6A)	ONE COAT MIL-DTL-24441, TYPE IV, F-150, 4-6 MILS  SEE NOTES (15A) & (28A)	ONE STRIPE COAT AND ONE FULL COAT MIL-DTL-24441, TYPE IV, F-151 OR F-157, 4-6 MILS/COAT  SEE NOTES (7A), (15A), (28A), & (33A)				
	5	POWER TOOL CLEAN TO BARE METAL, SSPC-SP 11  SEE NOTE (6A)	ONE COAT MIL- PRF-23236, TYPE V OR VI, CLASS 5 OR 7, 4 - 8 MILS  SEE NOTES (15A) & (28A)	ONE STRIPE COAT AND ONE FULL COAT MIL-PRF-23236, TYPE V OR VI, CLASS 5 OR 7, 4 - 8 MILS/COAT  SEE NOTES (7A), (9A), (15A), (28A), & (33A)				
VALVE REGULATED LEAD ACID (VRLA) BATTERY COMPARTMENT (SSN774, SSN21 AND SSN688 CLASS)	6	NEAR WHITE METAL BLAST, NACE 2/SSPC-SP 10	ONE COAT MIL-DTL-24441, TYPE IV, F-150, 4-6 MILS  SEE NOTES (15A) & (28A)	ONE STRIPE COAT, MIL-DTL- 24441, TYPE IV, F-151 or F-157, AND ONE FULL COAT, MIL- DTL-24441, TYPE IV, F-152, 4-6 MILS/COAT  SEE NOTES (7A), (15A), (28A), & (33A)				

TABLE 7 STEEL SURFACES  SUBMARINES	LINE	A SURFACE PREPARATION	B PRIMER	C	D	E BULKHEADS AND OVERHEADS	F THERMAL INSULATION	G
VRLA BATTERY COMPARTMENT (SSBN/SSGN- 726 CLASS)	7	NEAR WHITE METAL BLAST, NACE 2/SSPC-SP 10	"SINGLE COAT"  ONE COAT MIL-PRF-23236 TYPE VII, CLASS 7/18, 20 - 30 MILS  SEE NOTES (15A), (16A) & (40A)					
VA CLASS BATTERY COMPARTMENT (DECK AND BHDS UP TO 62" ABOVE TOP STEP OF DECK)	8	POWER TOOL CLEAN TO BARE METAL, SSPC-SP 11  SEE NOTE (6A)	TEK-HAZ RED PRIME COAT, 16-20 MILS  SEE NOTES (24A) & (28A)	TEK-HAZ GRAY TOPCOAT, 16-20 MILS  SEE NOTES (24A), (28A), & (33A)				
VA CLASS BATTERY COMPARTMENT (OVHD AND BHDS ABOVE 62" ABOVE TOP STEP OF DECK)	9	POWER TOOL CLEAN TO BARE METAL, SSPC-SP 11  SEE NOTE (6A)	ONE COAT MIL-DTL-24441, TYPE IV, F-150, 4 - 6 MILS  SEE NOTES (24A) & (28A)			2 COATS MIL-PRF- 24635, TYPE II, CLASS 1, 4-6 MILS/ COAT  SEE NOTES (24A), (28A), & (33A)		
TRUNK INTERIORS, UNINSULATED AREA ABOVE THE LOWER FLAT (INCLUDING UPPER HATCH COVER)  SEE NOTE (36A)	10	POWER TOOL CLEAN TO BARE METAL, SSPC-SP 11  SEE NOTES (6A) & (13A)	ONE COAT MIL-PRF-23236, TYPE VII, CLASS 17, 5 - 7 MILS  SEE NOTES (8A), (15A) & (28A)	ONE COAT MIL-PRF-23236, TYPE VII, CLASS 17, 5 - 7 MILS  SEE NOTE (7A), (8A), (9A), (15A), (28A), & (33A)				
	11	POWER TOOL CLEAN TO BARE METAL, SSPC-SP 11  SEE NOTE (6A)	ONE COAT MIL-DTL-24441, TYPE IV, F-150, 4-6 MILS  SEE NOTES (15A) & (28A)	ONE COAT MIL-DTL-24441, TYPE IV, F-151 OR F-157, 4-6 MILS  SEE NOTES (7A), (15A), & (28A)		ONE COAT MIL-DTL- 24607, 1-2 MILS  SEE NOTES (7A), (9A), (10A), (11A), (12A), (28A) & (33A)		
	12	POWER TOOL CLEAN TO BARE METAL, SSPC-SP 11  SEE NOTE (6A)	ONE COAT MIL- PRF-23236, TYPE V OR VI, CLASS 5 OR 7, 4 - 8 MILS  SEE NOTES (15A) & (28A)	ONE COAT MIL-PRF-23236, TYPE V OR VI, CLASS 5 OR 7, 4 - 8 MILS  SEE NOTES (7A), (9A), (15A), & (28A)		ONE COAT MIL-DTL- 24607, 1-2 MILS  SEE NOTES (7A), (9A), (10A), (11A), (12A), (28A) & (33A)		

TABLE 7 STEEL SURFACES  SUBMARINES	LINE	A SURFACE PREPARATION	B PRIMER	C	D	E BULKHEADS AND OVERHEADS	F THERMAL INSULATION	G
TRUNK INTERIORS UNDER INSULATION ABOVE THE LOWER FLAT  SEE NOTE (36A)	13	POWER TOOL CLEAN TO BARE METAL, SSPC-SP 11  SEE NOTE (6A)	ONE COAT MIL-DTL-24441, TYPE IV, F-150, 4-6 MILS  SEE NOTES (15A) & (28A)	ONE FULL COAT MIL-DTL-24441, TYPE IV, CONTRASTING COLOR, 4-6 MILS  SEE NOTES (15A), (28A), & (33A)				
	14	POWER TOOL CLEAN TO BARE METAL, SSPC-SP 11  SEE NOTE (6A)	ONE COAT MIL- PRF-23236, TYPE V OR VI, CLASS 5 OR 7, 4 - 8 MILS  SEE NOTES (15A) & (28A)	ONE FULL COAT MIL-PRF-23236, TYPE V OR VI, CLASS 5 OR 7, 4 - 8 MILS  SEE NOTES (15A), (28A), & (33A)				
MACHINERY SPACES (ENGINE ROOMS AND AUXILIARY MACHINERY ROOMS) UNINSULATED PRESSURE HULL	15	POWER TOOL CLEAN TO BARE METAL, SSPC-SP 11  SEE NOTE (6A)	ONE COAT MIL-DTL-24441, TYPE IV, F-150, 4-6 MILS  SEE NOTES (15A) & (28A)	ONE COAT MIL-DTL-24441, TYPE IV, F-151 OR F-157, 4-6 MILS  SEE NOTES (7A), (15A), & (28A)	2 COATS MIL-DTL-24607, 1-2 MILS/COAT  SEE NOTES (7A), (9A), (10A), (11A), (28A) & (33A)			
	16	POWER TOOL CLEAN TO BARE METAL, SSPC-SP 11  SEE NOTE (6A)	ONE COAT MIL- PRF-23236, TYPE V OR VI, CLASS 5 OR 7, 4 - 8 MILS  SEE NOTES (15A) & (28A)	ONE COAT MIL-PRF-23236, TYPE V OR VI, CLASS 5 OR 7, 4 - 8 MILS  SEE NOTES (7A), (9A), (15A), & (28A)	2 COATS MIL-DTL-24607, 1-2 MILS/COAT  SEE NOTES (7A), (9A), (10A), (11A), (28A) & (33A)			
MACHINERY SPACES (ENGINE ROOMS AND AUXILIARY MACHINERY ROOMS) PRESSURE HULL TO BE COVERED BY INSULATION	17	POWER TOOL CLEAN TO BARE METAL, SSPC-SP 11  SEE NOTE (6A)	ONE COAT MIL-DTL-24441, TYPE IV, F-150, 4-6 MILS  SEE NOTES (15A) & (28A)	ONE STRIPE COAT AND ONE FULL COAT MIL-DTL-24441, TYPE IV, F-151 OR F-157, 4-6 MILS/COAT  SEE NOTES (7A), (15A), (28A), & (33A)				
	18	POWER TOOL CLEAN TO BARE METAL, SSPC-SP 11  SEE NOTE (6A)	ONE COAT MIL- PRF-23236, TYPE V OR VI, CLASS 5 OR 7, 4 - 8 MILS  SEE NOTES (15A) & (28A)	ONE STRIPE COAT AND ONE FULL COAT MIL-PRF-23236, TYPE V OR VI, CLASS 5 OR 7, 4 - 8 MILS/COAT  SEE NOTES (7A), (9A), (15A), (28A), & (33A)				

TABLE 7 STEEL SURFACES  SUBMARINES	LINE	A SURFACE PREPARATION	B PRIMER	C	D	E BULKHEADS AND OVERHEADS	F THERMAL INSULATION	G
MACHINERY SPACE OVERHEADS AND BULKHEADS	19	POWER TOOL CLEAN TO BARE METAL, SSPC-SP 11  SEE NOTE (6A)	ONE COAT TT-P-645 F-84, 1-2 MILS	2 COATS MIL-DTL-24607, 1 - 2 MILS/COAT				
DECKS WITHOUT COVERINGS	20	POWER TOOL CLEAN TO BARE METAL, SSPC-SP 11  SEE NOTE (6A)	ONE COAT MIL-DTL-24441, TYPE IV, 2-4 MILS  SEE NOTES (7A), (15A), (25A), (28A), & (33A)	ONE COAT MIL-DTL-24441, TYPE IV, 2-4 MILS  SEE NOTES (7A), (15A), (28A), & (33A)				
	21	POWER TOOL CLEAN TO BARE METAL, SSPC-SP 11  SEE NOTE (6A)	ONE COAT MIL- PRF-23236, TYPE V OR VI, CLASS 5 OR 7, 4 - 8 MILS  SEE NOTES (15A) & (28A)	ONE FULL COAT MIL-PRF- 23236, TYPE V OR VI, CLASS 5 OR 7, 4 - 8 MILS  SEE NOTES (15A), (28A), & (33A)				
	22	POWER TOOL CLEAN TO BARE METAL, SSPC-SP 11  SEE NOTE (6A)	ONE COAT TT-P-645, F-84, 1-2 MILS  SEE NOTES (28A) & (33A)	2 COATS MIL-PRF-24635, 5 - 8 MILS/COAT  SEE NOTES (7A), (28A), & (33A)				
	23	POWER TOOL CLEAN TO BARE METAL, SSPC-SP 11  SEE NOTE (6A)	ONE COAT MIL-PRF-32584, TYPES I OR II, CLASS 2, 10 - 12 MILS  SEE NOTE (30A)	ONE COAT MIL-PRF-32584, TYPES I OR II, CLASS 2, 10 - 12 MILS  SEE NOTE (30A)				
DECKS WITH COVERINGS	24	POWER TOOL CLEAN TO BARE METAL, SSPC-SP 11  SEE NOTE (6A)	ONE COAT MIL-DTL-24441, TYPE IV, F-150, 2 - 4 MILS -OR- ONE COAT MIL- PRF-23236, TYPE V OR VI, CLASS 5 OR 7, 4 - 8 MILS  SEE NOTES (6A), (15A), (28A) & (33A)					

TABLE 7 STEEL SURFACES  SUBMARINES	LINE	A SURFACE PREPARATION	B PRIMER	C	D	E BULKHEADS AND OVERHEADS	F THERMAL INSULATION	G
	25	POWER TOOL CLEAN TO BARE METAL, SSPC-SP 11  SEE NOTE (6A)	ONE COAT MIL- PRF-23236, TYPE V OR VI, CLASS 5 OR 7, 4 - 8 MILS  SEE NOTES (15A) & (28A)					
ENSOLITE INSULATION (OVERCOAT)	26	DETERGENT WASH AND RINSE				2 COATS MIL-DTL- 24607, 1-2 MILS/COAT  SEE NOTES (7A), (9A), (10A), (11A), (28A) & (33A)		
POLYIMIDE INSULATION (OVERCOAT)	27	DETERGENT WASH AND RINSE				2 COATS MIL-DTL- 24607, 1-2 MILS/COAT  SEE NOTES (7A), (9A), (10A), (11A), (28A) & (33A)		
	28	DETERGENT WASH AND RINSE				2 COATS MIL-PRF- 24596, 1-2 MILS/COAT -OR- 2 COATS F-25A, 1-2 MILS/COAT  SEE NOTES (28A) & (33A)		
DRY VOIDS	29	POWER TOOL CLEAN TO BARE METAL, SSPC-SP 11  SEE NOTE (6A)	ONE COAT MIL- PRF-23236, TYPE V OR VI, CLASS 5 OR 7, 4 - 8 MILS  SEE NOTES (15A) & (28A)	ONE FULL COAT MIL-PRF- 23236, TYPE V OR VI, CLASS 5 OR 7, 4 - 8 MILS  SEE NOTES (15A), (28A), & (33A)				
	30	POWER TOOL CLEAN TO BARE METAL, SSPC-SP 11  SEE NOTE (6A)	ONE COAT MIL-DTL-24441, TYPE IV, 2-4 MILS  SEE NOTES (7A), (15A), (25A), (28A), & (33A)	ONE COAT MIL-DTL-24441, TYPE IV, 2-4 MILS  SEE NOTES (7A), (15A), (28A), & (33A)				



TABLE 8 STEEL SURFACES  SUBMARINES	LINE	A SURFACE PREPARATION	B PRIMER	C	D	E	F	G TOTAL
POTABLE WATER TANKS SEE NOTES (29A), (31A) & (34A)	1	NEAR WHITE METAL BLAST, NACE 2/SSPC-SP 10	ONE COAT MIL-PRF-23236, TYPE VII, CLASS 9, 4 - 8 MILS  SEE NOTES (15A), (39A), (5A), & (37A)		ONE COAT MIL-PRF-23236, TYPE VII, CLASS 9, 10-12 MILS WHITE OR OFF- WHITE  SEE NOTES (15A), (39A), & (37A)			
	2	NEAR WHITE METAL BLAST, NACE 2/SSPC-SP 10	"SINGLE COAT"  ONE COAT MIL-PRF-23236 TYPE VII CLASS 9/18, 20-30 MILS WHITE OR OFF- WHITE  SEE NOTES (15A), (39A), (5A), (37A), & (40A)					
	3	NEAR WHITE METAL BLAST, NACE 2/SSPC-SP 10	ONE COAT MIL-DTL-24441, TYPE III, F-150, 2 - 4 MILS  SEE NOTES (15A) & (21A)	ONE STRIPE COAT MIL- DTL-24441, TYPE III, 2 - 4 MILS  SEE NOTES (15A), & (21A)	ONE COAT MIL-DTL- 24441, TYPE III, 2 - 4 MILS  SEE NOTES (15A) & (21A)	ONE STRIPE COAT MIL- DTL-24441, TYPE III, 2-4 MILS  SEE NOTES (15A) & (21A)	ONE COAT MIL-DTL- 24441, TYPE III, F-152, 2-4 MILS DFT AT ADEQUATE THICKNESS TO MEET COATING RANGE  SEE NOTES (15A), (21A), & (27A)	TOTAL SYSTEM 8 -12 MILS (ON AREAS WITHOUT STRIPE COAT)  SEE NOTE (22A)
RESERVE FEEDWATER TANKS SEE NOTES (29A), (31A) & (34A)	4	NEAR WHITE METAL BLAST, NACE 2/SSPC-SP 10	ONE COAT MIL-DTL-24441, TYPE III, F-150, 2 - 4 MILS  SEE NOTES (15A) & (21A)	ONE STRIPE COAT MIL- DTL-24441 TYPE III F-152, 2 - 4 MILS  SEE NOTES (15A) & (21A)	ONE COAT MIL-DTL- 24441, TYPE III F-151, 2 - 4 MILS  SEE NOTES (15A) & (21A)	ONE STRIPE COAT MIL- DTL-24441, TYPE III, F-150, 2 - 4 MILS  SEE NOTES (15A) & (21A)	ONE COAT MIL-DTL-24441 TYPE III F-152, 2 - 4 MILS  SEE NOTES (15A) & (21A)	TOTAL SYSTEM 8 MILS MIN
AUXILIARY TANKS, ACR HOLDING TANKS (MTS), DEPTH CONTROL TANKS, NFO EXPANSION TANK, SEAWATER EXPANSION TANK, SECONDARY SHIELD WATER OVERFLOW TANK (MTS), TRIM TANKS, WATER ROUND TORPEDO (WRT) TANKS  SEE NOTE (29A)	5	NEAR WHITE METAL BLAST, NACE 2/SSPC-SP 10	"SINGLE COAT"  ONE COAT MIL-PRF-23236, TYPE VII, CLASS 7/18, 20-30 MILS  SEE NOTES (15A), (16A), (40A), & (5A)					

TABLE 8 STEEL SURFACES  SUBMARINES	LINE	A SURFACE PREPARATION	B PRIMER	C	D	E	F	G TOTAL
BILGE AND DRAIN COLLECTION TANKS  SEE NOTES (25A) & (29A)	6	NEAR WHITE METAL BLAST, NACE 2/SSPC-SP 10	"SINGLE COAT"  ONE COAT MIL-PRF-23236, TYPE VII, CLASS 5/18, 20-30 MILS  SEE NOTES (15A), (40A), & (5A)					
BOW TANK, BOW SONAR TANK, SONAR DOME AREA STEEL STRUCTURE (INCLUDES SONAR SPHERE, ITS SUPPORT STRUCTURE, AND FORWARD SIDE OF MBT BULKHEAD)  SEE NOTE (29A)	7	NEAR WHITE METAL BLAST, NACE 2/SSPC-SP 10	"SINGLE COAT"  ONE COAT MIL-PRF-23236, TYPE VII, CLASS 7/18, 20-30 MILS  SEE NOTES , (18A), (19A), (40A), & (5A)					
FUEL OIL OVERFLOW/COLLECTING TANK, FUEL OIL FILTER SUMP DRAIN TANK, DIESEL FUEL OIL TANK (MTS)  SEE NOTE (29A)	8	NEAR WHITE METAL BLAST, NACE 2/SSPC-SP 10	ONE COAT MIL-DTL-24441, TYPE IV, F-150, 4 - 6 MILS  SEE NOTE (19A)	ONE STRIPE COAT MIL- DTL-24441, TYPE IV, 4 - 6 MILS	ONE COAT MIL-DTL- 24441, TYPE IV, F-152 OR F-151, 4 - 6 MILS			
	9	NEAR WHITE METAL BLAST, NACE 2/SSPC-SP 10	ONE COAT MIL-PRF-23236 TYPE V OR VI, CLASS 5, 4 - 8 MILS  SEE NOTES (19A), & (5A)	ONE STRIPE COAT MIL- PRF-23236 TYPE V OR VI, CLASS 5, 4 - 8 MILS	ONE COAT MIL-PRF-23236 TYPE V OR VI, CLASS 5, 4 - 8 MILS			
	9A	NEAR WHITE METAL BLAST, NACE 2/SSPC-SP 10	"SINGLE COAT"  ONE COAT MIL-PRF-23236, TYPE VII, CLASS 5/18, 20-30 MILS  SEE NOTES (15A), (40A), & (5A)					
MAIN BALLAST TANKS ABOVE RESIDUAL WATER LINE; HIGH PRESSURE AIR FLASKS IN MBT'S, EMBT AIR FLASKS IN MBT'S  SEE NOTE (29A)	10	NEAR WHITE METAL BLAST, NACE 2/SSPC-SP 10  SEE NOTE (23A)	"SINGLE COAT"  ONE COAT MIL-PRF-23236, TYPE VII, CLASS 7/18, 20-30 MILS  SEE NOTES (16A), (17A), (18A), (19A), (40A), & (5A)					

TABLE 8 STEEL SURFACES	LINE	A SURFACE PREPARATION	B PRIMER	C	D	E	F	G TOTAL
<b>SUBMARINES</b>								
MAIN BALLAST TANKS BELOW RESIDUAL WATER LINE  SEE NOTE (29A)	11	NEAR WHITE METAL BLAST, NACE 2/SSPC-SP 10	"SINGLE COAT"  ONE COAT MIL-PRF-23236, TYPE VII, CLASS 7/18, 20-30 MILS  SEE NOTES (16A), (17A), (18A), (19A), (40A), & (5A)		ONE COAT MIL-PRF-24647 PRIMER, 1 - 2 MILS	2 COATS AF MIL-PRF- 24647 RED, 4-6 MILS, FROM BOTTOM CENTERLINE TO APPROXIMATELY 2' VERTICALLY ABOVE HEIGHT OF HIGHEST FLOOD LOUVER  SEE NOTES (4A) & (26A)		
MAIN INDUCTION SUMP TANK, MISSILE COMPENSATING TANKS  SEE NOTE (29A)	12	NEAR WHITE METAL BLAST, NACE 2/SSPC-SP 10	"SINGLE COAT"  ONE COAT MIL-PRF-23236, TYPE VII, CLASS 7/18, 20-30 MILS  SEE NOTES (15A), (40A), & (5A)					
TORPEDO IMPULSE TANKS  SEE NOTE (29A)	13	NEAR WHITE METAL BLAST, NACE 2/SSPC-SP 10	ONE COAT MIL-DTL-24441, TYPE IV, F-150, 4-6 MILS  SEE NOTES (15A) & (17A),	ONE STRIPE COAT MIL- DTL-24441, TYPE IV, 4-6 MILS  SEE NOTES (15A) & (17A)	ONE COAT MIL-DTL- 24441, TYPE IV, F-152 OR F-151, 4-6 MILS  SEE NOTES (15A) & (17A)			
	14	NEAR WHITE METAL BLAST, NACE 2/SSPC-SP 10	ONE COAT MIL-PRF-23236, TYPE V OR VI, CLASS 7, GRADE B OR C, 4 - 8 MILS  SEE NOTES (15A), (17A), & (5A)	ONE STRIPE COAT MIL- PRF-23236, TYPE V OR VI, CLASS 7, GRADE B OR C, 4 - 8 MILS  SEE NOTES (15A) & (17A)	ONE COAT MIL-PRF-23236, TYPE V OR VI, CLASS 7, GRADE B OR C, 4 - 8 MILS  SEE NOTES (15A) & (17A)			
TORPEDO IMPULSE TANKS (SSBN/SSGN ONLY)  SEE NOTE (29A)	15	NEAR WHITE METAL BLAST, NACE 2/SSPC-SP 10	"SINGLE COAT"  ONE COAT MIL-PRF-23236, TYPE VII, CLASS 7/18, 20-30 MILS  SEE NOTES (15A), (17A), (19A), (40A), & (5A)					
SANITARY TANKS  SEE NOTE (29A)	16	NEAR WHITE METAL BLAST, NACE 2/SSPC-SP 10	ONE COAT MIL-PRF-23236, TYPE VII, CLASS 13, 4 - 8 MILS  SEE NOTES (15A) & (5A)		ONE COAT MIL-PRF-23236, TYPE VII, CLASS 13, 10-12 MILS  SEE NOTE (15A)			

TABLE 8 STEEL SURFACES  SUBMARINES	LINE	A SURFACE PREPARATION	B PRIMER	C	D	E	F	G TOTAL
	17	NEAR WHITE METAL BLAST, NACE 2/SSPC-SP 10	"SINGLE COAT"  ONE COAT MIL-PRF-23236, TYPE VII, CLASS 13/18, 20- 30 MILS  SEE NOTES (15A), (40A), & (5A)					
STEAM PLANT SURGE TANKS (MTS) SEE NOTE (29A)	18	NEAR WHITE METAL BLAST, NACE 2/SSPC-SP 10	ONE COAT OF APEXIOR NO. 1 (DAMPNEY CO.), 2 - 4 MILS  SEE NOTE (47A)	ONE COAT OF APEXIOR NO. 1 (DAMPNEY CO.), 2 - 4 MILS  SEE NOTE (47A)				
WASTE OIL COLLECTING TANKS, WASTE OIL OVERFLOW TANKS, ENGINE ROOM OIL COLLECTION TANKS  SEE NOTE (29A)	19	NEAR WHITE METAL BLAST, NACE 2/SSPC-SP 10	ONE COAT MIL-PRF-23236, TYPE VII, CLASS 5, 4 - 8 MILS  SEE NOTES (15A), & (5A)		ONE COAT MIL-PRF-23236, TYPE VII, CLASS 5, 10 - 12 MILS  SEE NOTE (15A)			
	20	NEAR WHITE METAL BLAST, NACE 2/SSPC-SP 10	"SINGLE COAT"  ONE COAT MIL-PRF-23236, TYPE VII, CLASS 5/18, 20-30 MILS  SEE NOTES (15A), (40A), & (5A)					

TABLE 8 STEEL SURFACES  SUBMARINES	LINE	A SURFACE PREPARATION	B PRIMER	C	D	E	F	G TOTAL
FREE FLOOD AREAS AND RECESSES: INSIDE SURFACES OF FAIRWATER, UNDERSIDE OF SUPERSTRUCTURE, CHAIN LOCKERS, INTERIOR SURFACES OF STEEL DOMES, SHAFT TUBE INTERIOR SURFACES (WHEN SHAFT IS REMOVED), BOW DOME ACCESS FREE FLOOD AREA, BSY-1 RECESS (FRAME (FR) 29-30 STARBOARD (STBD)), 726 CLASS ACCESS SONAR DOME RECESS (FR 6-7 PORT), 726 CLASS SONAR SPHERE EXTERNAL SURFACES, 726 CLASS SONAR TRUNK EXTERNAL SURFACES, 726 CLASS SONAR DOME BULKHEAD (BHD) (FR 4), 726 CLASS SONAR CAVITY (FR 6-8), 726 CLASS SONAR DOME ACCESS TRUNK (FR 6-7), CAPSTAN RECESS, SONAR PENETRATION SPLICE TRUNK RECESSES (PORT AND STBD), SONAR CABLE TRUNK, EMERGENCY TOWING PENDANT, BETWEEN BLADES COVER PLATES (BBCP) RECESS, 726 CLASS MSS RECESS AT BHD 4, SHAFT TUBE HULL INSERTS  SEE NOTE (29A)	21	NEAR WHITE METAL BLAST, NACE 2/SSPC-SP 10	"SINGLE COAT"  ONE COAT MIL-PRF-23236, TYPE VII, CLASS 7/18, 20-30 MILS  SEE NOTES (1A), (32A) & (40A)					

TABLE 8 STEEL SURFACES  SUBMARINES	LINE	A SURFACE PREPARATION	B PRIMER	C	D	E	F	G TOTAL
FREE FLOOD AREAS AND RECESSES: TORPEDO TUBE RECESS, AFT FREE FLOOD AREA (MUD TANK), EJECTION PUMP RECESS, SECONDARY PROPULSION MOTOR (SPM) RECESS, SSN-688 CLASS BQN-17, BSY-1 OR AN/BBQ-10/V(1) RECESS (FR 14-15 PORT BOTTOM), 726 CLASS ANCHOR RECESS  SEE NOTE (29A)	22	NEAR WHITE METAL BLAST, NACE 2/SSPC-SP 10	"SINGLE COAT"  ONE COAT MIL-PRF-23236, TYPE VII, CLASS 7/18, 20-30 MILS          SEE NOTES (1A), (32A) & (40A)			ONE COAT MIL-PRF-24647 PRIMER, 1 – 2 MILS	2 AF COATS MIL-PRF- 24647 TYPE I OR II, RED, 4 – 6 MILS/COAT          SEE NOTE (4A)	
ALL OTHER FREE FLOOD AREAS, RECESSES BELOW UPPER BOOTTOP (APPLIES TO FREE FLOOD AREAS, RECESSES, AND VOIDS NOT LISTED ELSEWHERE IN THIS TABLE)  SEE NOTE (29A)	23	NEAR WHITE METAL BLAST, NACE 2/SSPC-SP 10	"SINGLE COAT"  ONE COAT MIL-PRF-23236, TYPE VII, CLASS 7/18, 20-30 MILS  SEE NOTES (1A), (16A), (26A), (32A), (40A), & (5A)			ONE COAT MIL-PRF-24647 PRIMER, 1 – 2 MILS	2 AF COATS MIL-PRF- 24647, TYPE I OR II, 4 – 6 MILS/COAT	
	24	NEAR WHITE METAL BLAST, NACE 2/SSPC-SP 10	ONE COAT MIL-PRF-23236, TYPE VII, CLASS 7, 4 – 8 MILS  SEE NOTES (1A), (36A), & (5A)		ONE COAT MIL-PRF-23236, TYPE VII, CLASS 7, 10 – 12 MILS  SEE NOTE (4A)	ONE COAT MIL-PRF-24647 PRIMER, 1 – 2 MILS	2 AF COATS MIL-PRF- 24647, TYPE I OR II, 4 – 6 MILS/COAT	

TABLE 8 STEEL SURFACES  SUBMARINES	LINE	A SURFACE PREPARATION	B PRIMER	C	D	E	F	G TOTAL
	25	NEAR WHITE METAL BLAST, NACE 2/SSPC-SP 10	ONE COAT MIL-PRF-23236, TYPE V OR VI, CLASS 5 OR 7, 4 - 8 MILS -OR- ONE COAT MIL-DTL-24441 TYPE IV, F-150, 4 - 6 MILS -OR- ONE AC COAT MIL-PRF- 24647, TYPE I OR II, 4-6 MILS  SEE NOTES (1A), (16A), & (5A)	ONE STRIPE COAT MIL- PRF-23236, TYPE V OR VI, CLASS 5 OR 7, 4 - 8 MILS -OR- ONE STRIPE COAT MIL- DTL-24441 TYPE IV, F-151 OR F-152, 4-6 MILS -OR- ONE AC STRIPE COAT MIL-PRF-24647, TYPE I OR II, 4-6 MILS	ONE COAT MIL-PRF-23236, TYPE V OR VI, CLASS 5 OR 7, 4 - 8 MILS -OR- ONE COAT MIL-DTL-24441 TYPE IV, F-151 OR F-152, 4- 6 MILS -OR- ONE AC COAT MIL-PRF- 24647, TYPE I OR II, 4-6 MILS  SEE NOTE (4A)	ONE COAT MIL-PRF-24647 PRIMER, 1 – 2 MILS	2 AF COATS MIL-PRF- 24647, TYPE I OR II, 4 – 6 MILS/COAT	
ALL OTHER FREE FLOOD AREAS, RECESSES ABOVE UPPER BOOTTOP (APPLIES TO FREE FLOOD AREAS, RECESSES, AND VOIDS NOT LISTED ELSEWHERE IN THIS TABLE)  SEE NOTE (29A)	26	NEAR WHITE METAL BLAST, NACE 2/SSPC-SP 10	"SINGLE COAT"  ONE COAT MIL-PRF-23236, TYPE VII, CLASS 7/18, 20-30 MILS  SEE NOTES (1A), (16A), (26A), (32A) & (40A)					
	27	NEAR WHITE METAL BLAST, NACE 2/SSPC-SP 10	ONE COAT MIL-PRF-23236, TYPE VII, CLASS 7, 4 – 8 MILS  SEE NOTES (1A), (16A), & (36A)		ONE COAT MIL-PRF-23236, TYPE VII, CLASS 7, 10 – 12 MILS  SEE NOTES (32A) & (36A)			
	28	NEAR WHITE METAL BLAST, NACE 2/SSPC-SP 10	ONE COAT MIL-PRF-23236, TYPE V OR VI, CLASS 5 OR 7, 4 - 8 MILS -OR- ONE COAT MIL-DTL-24441 TYPE IV, F-150, 4 - 6 MILS -OR- ONE AC COAT MIL-PRF- 24647, TYPE I OR II, 4-6 MILS  SEE NOTES (1A) & (16A)	ONE STRIPE COAT MIL- PRF-23236, TYPE V OR VI, CLASS 5 OR 7, 4 - 8 MILS -OR- ONE STRIPE COAT MIL- DTL-24441 TYPE IV, F-151 OR F-152, 4-6 MILS -OR- ONE AC STRIPE COAT MIL-PRF-24647, TYPE I OR II, 4-6 MILS	ONE COAT MIL-PRF-23236, TYPE V OR VI, CLASS 5 OR 7, 4 - 8 MILS -OR- ONE COAT MIL-DTL-24441 TYPE IV, F-151 OR F-152, 4- 6 MILS -OR- ONE AC COAT MIL-PRF- 24647, TYPE I OR II, 4-6 MILS  SEE NOTE (32A)			
CLEAN FUEL OIL, HYDRAULIC OIL, LUBE OIL SLUDGE, & HYDROPHONE TANKS	29	POWER TOOL CLEAN, SSPC-SP 3	ONE COAT MIL-DTL-24441, TYPE IV, F-150, 4-6 MILS  SEE NOTE (15A)	MIL-DTL-24441, TYPE IV, F-152 OR F-151, 4-6 MILS  SEE NOTE (15A)				

TABLE 8 STEEL SURFACES	LINE	A SURFACE PREPARATION	B PRIMER	C	D	E	F	G TOTAL
SUBMARINES SEE NOTES (29A) & (20A)	30	COMMERCIAL BLAST, NACE 3/SSPC-SP 6 OR POWER TOOL CLEAN TO BARE METAL SSPC-SP 11						
NORMAL FUEL OIL (688 AND 726 CLASS: FROM BASELINE TO 4 FEET ABOVE BASELINE, 774 CLASS: FROM BASELINE TO 9 FEET ABOVE BASELINE)  SEE NOTE (29A) & (20A)	31	COMMERCIAL BLAST, NACE 3/SSPC-SP 6 OR POWER TOOL CLEAN TO BARE METAL SSPC-SP 11						
	32	NEAR WHITE METAL BLAST, NACE 2/SSPC-SP 10  SEE NOTE (14A)	ONE COAT MIL-DTL-24441, TYPE IV, F-150, 4 - 6 MILS  SEE NOTE (15A)	ONE STRIPE COAT MIL- DTL-24441, TYPE IV, 4 - 6 MILS  SEE NOTE (15A)	ONE COAT MIL-DTL- 24441, TYPE IV, F-152 OR F-151, 4 - 6 MILS  SEE NOTE (15A)			
TANK MANHOLE COVERS  SEE NOTE (29A)	33	NEAR WHITE METAL BLAST, NACE 2/SSPC-SP 10	ONE COAT MIL-PRF-23236, TYPE VIII, 5-9 MILS --OR-- USE APPROVED COATING SYSTEM SPECIFIED FOR TANK OR FREEFLOOD  SEE NOTES (15A), (21A), (31A), & (41A)					
FREEFLOOD ACCESS COVERS  SEE NOTE (29A)	34	NEAR WHITE METAL BLAST, NACE 2/SSPC-SP 10	2 COATS AC MIL-PRF-24647, TYPE I OR II, 4-6 MILS/COAT  SEE NOTE (32A)			2 AF COATS MIL-PRF- 24647, TYPE I OR II, 4-6 MILS/COAT  SEE NOTES (2A), (3A), (4A), (7A), & (32A)		
	35	NEAR WHITE METAL BLAST, NACE 2/SSPC-SP 10	2 COATS MIL- PRF-23236, TYPE V OR VI CLASS 5 OR 7, 4 - 8 MILS/COAT  SEE NOTE (32A)			2 AF COATS MIL-PRF- 24647, TYPE I OR II, 4-6 MILS/COAT  SEE NOTES (2A), (3A), (4A), (7A), & (32A)		
	36	NEAR WHITE METAL BLAST, NACE 2/SSPC-SP 10	ONE COAT MIL-DTL-24441, TYPE IV, F-150, 4-6 MILS --- & --- ONE COAT MIL-DTL-24441, TYPE IV, F-151 OR F-152, 4-6 MILS  SEE NOTE (32A)			2 AF COATS MIL-PRF- 24647, TYPE I OR II, 4-6 MILS/COAT  SEE NOTES (2A), (3A), (4A), (7A), & (32A)		



TABLE 8 STEEL SURFACES  SUBMARINES	LINE	A SURFACE PREPARATION	B PRIMER	C	D	E	F	G TOTAL
WSQ-9 RECESS AND ASSOCIATED OUTBOARD TRANSDUCER ARRAY ASSEMBLY FOUNDATION  SEE NOTE (29A)	37	NEAR WHITE METAL BLAST, NACE 2/SSPC-SP 10	"SINGLE COAT" ONE COAT MIL-PRF-23236, TYPE VII, CLASS 7/18, 20 – 30 MILS  SEE NOTES (1A), (5A), (32A), (40A) & (48A)	ONE COAT MIL-PRF-24647 PRIMER, 1-2 MILS ---OR--- ONE COAT MIL-PRF-24441 TYPE IV, F150, 1-2 MILS  SEE NOTES (1A), (4A), AND (45A)		2 AF COATS COMMERCIAL GRADE WHITE AF, 2 – 4 MILS/ COAT		

NAVSEA  
STANDARD ITEM

FY-24

ITEM NO: 009-33  
DATE: 25 OCT 2022  
CATEGORY: II

1. SCOPE:

1.1 Title: Rotating Electrical Equipment; rewind

2. REFERENCES:

2.1 Standard Items

2.2 Equipment Technical Manual

2.3 S9086-DA-STM-010/CH-100, Hull Structures

2.4 S9086-KC-STM-010/CH-300, Electric Plant - General

2.5 S9086-KE-STM-010/CH-302, Electric Motors and Controllers

2.6 S9086-KN-STM-010/CH-310, Electric Power Generators and Conversion Equipment

2.7 S9086-HN-STM-010/CH-244, Propulsion Bearings and Seals

2.8 S6260-BJ-GTP-010, Electrical Machinery Repair, Electric Motor, Shop Procedures Manual

2.9 MIL-DTL-17060, MOTORS, ALTERNATING CURRENT, INTEGRAL-HORSEPOWER, SHIPBOARD USE

2.10 S9310-AC-HBK-010, Commutator/Slip Ring Maintenance Handbook

2.11 MIL-STD-1310, Shipboard Bonding, Grounding, and Other Techniques for Electromagnetic Compatibility, Electromagnetic Pulse (EMP) Mitigation, and Safety

2.12 407-5291780, Standard Electromagnetic Interference (EMI) Survey Procedures

2.13 T9070-A2-DPC-010/302-1, AC MOTOR AND CONTROLLER APPLICATION REQUIREMENTS

3. REQUIREMENTS:

3.1 Disconnect equipment mechanically and remove, including rotating components connected directly to the shaft, using 2.2 for guidance.

3.1.1 Accomplish the following prior to disconnecting: measure air gap readings; measure bearing clearances for sleeve bearing equipment only; measure alignment readings; inspect couplings for cracks, broken segments, wear, and misalignment in excess of tolerances specified in 2.2; measure shaft thrust and run out readings; identify associated cables/wiring and hook-up data. Record data in Attachment B-2 or equivalent form that contains the requirements of Attachment B-2.

3.1.2 Matchmark, identify, and retain chocks, shims, shock mounts, sound damping pads, and other accessories associated with equipment. Record list of accessories in Attachment B-2 or equivalent form that contains the requirements of Attachment B-2.

3.1.3 Remove entire vaneaxial and tubeaxial fan assemblies from the duct system and transport to the shop for repair.

3.2 Accomplish a structural inspection of each foundation in accordance with 2.3. Record data in Attachment B-2 or equivalent form that contains the requirements of Attachment B-2.

3.2.1 Accomplishment of cleaning and painting requirements for foundations of equipment must be in accordance with NAVSEA Standard Items (See 4.7).

3.3 Matchmark, disassemble, inspect, measure, and test the equipment removed in 3.1 using 2.2 and 2.4 through 2.8 for guidance.

3.3.1 Accomplish a core loss test prior to winding removal in accordance with Paragraphs 300-4.5.6 and 300-4.5.6.1 of 2.4. Inspect for hot spots in accordance with the Core Loss Tester Instruction Manual. Record data in Attachment B-1 or equivalent form that contains the requirements of Attachment B-1.

3.3.1.1 Accomplish a loop test in accordance with Paragraph 300-4.5.6.1.2 of 2.4 when core indicates a marginal satisfactory reading or when test equipment does not directly support equipment being subjected to testing. Record data in Attachment B-1 or equivalent form that contains the requirements of Attachment B-1.

3.3.2 Remove each winding, using Paragraph 300-4.5.7.2 of 2.4 for guidance for winding removal and 2.8 for core inspection. Verify the temperature limitations of the core material prior to exercising the burnout oven option. Record winding data in Attachment B-1 or equivalent form that contains the requirements of Attachment B-1. Verify conformance of recorded data to the manufacturer's winding data.

3.3.2.1 Repeat core loss test and inspection described in 3.3.1 and loop test described in 3.3.1.1 after winding removal. Record data in Attachment B-1 or equivalent form that contains the requirements of Attachment B-1.

3.3.3 Dip core in a 20 percent solution of varnish MIL-I-24092 and dry. In localities where MIL-I-24092 does not meet state and local Air Pollution Control District (APCD) standards, spray the iron core with a clear air-drying varnish.

3.3.4 Protect machined surfaces. Accomplishment of cleaning and painting for equipment housing exterior, fan(s), core and interior and exterior of each end bell must be in accordance with NAVSEA Standard Items (See Note 4.7).

3.3.5 Inspect and test non-wound rotors for loose or cracked bars, localized overheating, and rubbing in accordance with 2.8. Inspect wound rotors, slip ring leads, and armatures for insulation damage and burns/hot spots. Inspect for loose coils and slot wedges. Inspect slip rings and commutators for damage and for wear limits, using 2.2 for criteria. Inspect brush rigging for cracks, chips, worn areas, distortion, spring condition, and insulating material for cracks and arc paths. Inspect leads and terminal lugs for damage and defects. Identify and tag leads with aluminum wrap-around bands with metal stamped or embossed markings. Record data in Attachment B-1 or equivalent form that contains the requirements of Attachment B-1.

3.3.6 Inspect and dimensionally measure end bells, frame, rabbet fits, shaft, sleeve and pedestal bearings, keyways, fan and running surfaces for wear, eccentricity, and other defects, using 2.2 for accept or reject criteria, and 2.7 for location and type of measurements to be taken. Record data in Attachment C or equivalent form that contains the requirements of Attachment C.

3.3.7 Accomplish commutator pre-installation and post-installation test, using Table 300-3-9 of 2.4 for guidance. Record data in Attachment B-1 or equivalent form that contains the requirements of Attachment B-1.

3.4 Rewind the equipment in accordance with Original Equipment Manufacturers (OEM) "for Navy use" winding data. Connect windings permanently only after successful completion of testing of 3.5.1 and 3.5.3 through 3.5.5. Install new material conforming to: Magnet wire, National Electrical Manufacturers Association (NEMA) MW-1000, Table MW 16 (round wire), or NEMA MW-1000, Table MW 20 (rectangular wire), or equivalent to OEM original; Slot and phase insulation, NEMA FI-3-2004; Slot wedge-spacers and fillers, MIL-I-24768/17; Lead wire, stranded, MIL-DTL-16878 except for type EPDM, which may be commercial grade; Glass banding, MIL-I-24178; Temperature detectors in accordance with 2.2.

3.5 Test, inspect, and measure the rewound equipment.

3.5.1 Accomplish a 500-volt megger insulation resistance test, using Paragraphs 300-3.2.2 through 300-3.2.3, 300-3.4.8, 300-3.4.11, and 300-5.3.7.1 of 2.4 for guidance. Record data in Attachment B-1 or equivalent form that contains the requirements of Attachment B-1.

3.5.2 Disconnect solid-state devices and ground temperature-sensing leads prior to measuring insulation resistance of windings.

3.5.3 Accomplish a phase resistance balance test of windings, using a Wheatstone or Kelvin bridge, or with an ohmmeter capable of resolving one milliohm (0.001 ohm). Record phase balance for multi-phase equipment, using Paragraph 5.21 of 2.8 and 3.6.1 of 2.9 for guidance. Record data in Attachment B-1 or equivalent form that contains the requirements of Attachment B-1.

3.5.4 Accomplish a voltage surge test in accordance with Paragraphs 300-3.5.4 through 300-3.5.5 of 2.4. Record data in Attachment B-1 or equivalent form that contains the requirements of Attachment B-1.

3.5.5 Accomplish a DC HI POT test in accordance with Paragraph 300-3.5.2 through 300-3.5.2.3.4 of 2.4. Record data in Attachment B-1 or equivalent form that contains the requirements of Attachment B-1.

3.6 Connect the windings permanently.

3.6.1 Repeat tests described in 3.5.1 and 3.5.3 through 3.5.5. Record data in Attachment B-1 or equivalent form that contains the requirements of Attachment B-1.

3.6.2 Accomplish DC bar-to-bar test on commutators after making coil connections to the risers in accordance with Paragraph 300-4.7.11.3 of 2.4. Record data in Attachment B-1 or equivalent form that contains the requirements of Attachment B-1.

3.6.3 Accomplish a Polarization Index Test in accordance with Paragraph 300-3.4.12 of 2.4. Record data in Attachment B-1 or equivalent form that contains the requirements of Attachment B-1.

3.7 Select the proper insulating process based on winding insulation classifications and to meet state or local air pollution standards. Select varnish methods and material, using Paragraphs 300-4.5.8 through 300-4.5.8.9 of 2.4 for guidance. Maintain the varnish in accordance with Paragraphs 300-4.5.8.3 through 300-4.5.8.3.3 of 2.4 and the varnish manufacturer's instructions. Maintain a current revision of the varnish manufacturer's instructions on storage, maintenance, and use of the type of varnish to be applied. Maintain a record of varnish temperature, viscosity and, for solventless varnish, gel time tests. Tests must show varnish is within varnish manufacturer's recommendations and have been accomplished in the intervals specified by the varnish manufacturer. The record must also show that the varnish is being stored as recommended by the varnish manufacturer.

3.8 Varnish and bake windings in accordance with Paragraphs 300-4.5.8.4 of 2.4 and the varnish manufacturer's instructions. Do not immerse the leads. Wipe surfaces that affect assembly, such as rabbit fits and mounting flanges, with a cloth moistened with a solvent after draining and before baking. Remove excess varnish run-off from surfaces that affect assembly

after baking. Apply a thin coat of air-dry varnish to metal surfaces exposed by the removal process in accordance with Paragraph 300-4.5.8.5 and 300-4.5.8.6 of 2.4.

3.9 Repeat tests described in 3.5.1 and 3.5.3 through 3.5.5. Record data in Attachment B-1 or equivalent form that contains the requirements of Attachment B-1.

3.10 Accomplish an AC HI POT test in accordance with Paragraphs 300-3.5.3 through 300-3.5.3.2.9 of 2.4. Record data in Attachment B-1 or equivalent form that contains the requirements of Attachment B-1.

3.11 True the commutator or collector rings. Eccentricity must not exceed the requirements of 2.10. Resurface or machine each individual collector ring to the same exact diameter to allow symmetrical brush holder to ring clearance spacing. Ensure metal shavings are not permitted to contaminate the rotor or stator assembly. Each cut must not exceed 0.010 inch. Finish thickness must not be less than design wear tolerance as shown in 2.2. Undercut the mica between the commutator bars with the edge of the mica not exceeding a depth of 5/64-inch below the bars. Chamfer the bar edges and remove rough surfaces in accordance with Paragraph 7-4.1.3 of 2.10. Burnish the commutator with a very fine commercial burnishing stone conforming to A-A-58052. Polish collector rings to a mirror finish. Record data in Attachment B-1 or equivalent form that contains the requirements of Attachment B-1.

3.12 Accomplishment of the balancing requirement for each rotating assembly must be in accordance with NAVSEA Standard Items (See Note 4.6).

3.13 Disassemble the brush rigging. Remove foreign matter. Replace existing cadmium-plated parts with zinc in accordance with ASTM A 153. Recondition threads of plated parts. Assemble brush rigging.

3.14 Install identification markers on wiring in the external connection box.

3.14.1 Markers must be aluminum wrap-around type with metal stamped or embossed markings.

3.15 Repair lightly scored areas of frame, end bells, and shaft by manual methods. Recondition threads and fit key to keyway. Visually inspect keyway for deformed, cracked or chipped edges or high spots. Verify that fit between key and key-seat sides has a minimum clearance of 0.002 inch or maximum interference of 0.0005 inch. High spots in keyway may be removed by machining or grinding. Do not unnecessarily repair any keyway; instead, use a step key up to a maximum of 0.010 inch oversize and, where possible, include a radius in step. If key tightness cannot be corrected with a step key, machine worn/damaged keyways to recommended over-sizes as follows: Maximum of 0.015 inch oversize for a 1/8-inch key and increasing oversize allowance of 0.010 inch for each 1/8-inch increase in key size up to a maximum of 0.075 inch. If key tightness cannot be corrected by keyway repair, replace part involved. Apply

a thin coat of petrolatum to unpainted mating surfaces except for explosion-proof motors, which must have clean, dry mating surfaces.

3.16 Prepare and refinish equipment. Protect machine surfaces, windings, and nameplates from being painted or otherwise damaged.

3.16.1 Accomplishment of cleaning and painting for housing, fan, and interior and exterior of each end bell must be in accordance with NAVSEA Standard Items (See Note 4.7).

3.17 Accomplish the following on equipment having other than sleeve-type bearings unless otherwise specified in the invoking Work Item, using 2.8 for guidance.

3.17.1 Install new bearings, seals, fittings, lock washers, and locknuts conforming to 2.2, using 2.7 and Chapter 6 of 2.8 for guidance, except as indicated in 3.17.1.1 (utilizing Attachment A for guidance).

3.17.1.1 Install Type 111, Class 8 (double seal) bearings in motors meeting the criteria identified in Chapter 6 of 2.8. Only double seal bearings identified in Chapter 6 of 2.8 are acceptable for this use.

3.17.1.2 Install Type 111, Class 8 (double seal), bearings with a C3 (greater than normal) radial internal clearance, if not originally furnished or already accomplished during previous repair, in place of the Type 111 bearing originally furnished, for vaneaxial and tubeaxial fan motors not meeting the criteria of Chapter 6 of 2.8. Install Type 120 bearings in vaneaxial and tubeaxial fan motors originally furnished with Type 120 bearings.

3.17.1.3 Install new label plates with the inscription "DO NOT LUBRICATE" on equipment using double seal bearings (Type 111, Class 8 or Type 120).

3.17.1.4 Install pipe plugs on all grease fills and drains for equipment converted from re-lubricable bearings to double seal bearings.

3.17.1.5 Prepare a report that reflects the change in the maintenance requirements for the converted motor, for equipment converted from lubricated bearings to double seal bearings. Record data in Attachment B-1 or equivalent form that contains the requirements of Attachment B-1.

3.17.2 Lubricate bearings with grease conforming to MIL-PRF-24508 in accordance with Paragraphs 244-1.7.7.2 and 244-1.7.7.3 of 2.7, for equipment not using double seal bearings.

3.18 Assemble the equipment using 2.2 and 2.4 through 2.8 for guidance. Do not use materials containing silicone in the repair and assembly of equipment with commutator or collector rings. Install new gaskets on covers, inspection plates, and between the external connection box and the frame. Gaskets must conform to MIL-PRF-1149 unless otherwise

specified in 2.2. Set brush holders not less than 1/16-inch or more than 1/8-inch from commutator or collector rings unless otherwise specified in 2.2; set in electrical neutral plane and stagger brushes for maximum coverage of the commutator, in accordance with Paragraph 300-4.7.7.1.10 of 2.4; center over the collector rings; ensure the brushes do not extend beyond the edge of the collector rings; install new brushes in accordance with 2.2; sand new brushes to fit curvature of the commutator or collector rings in accordance with Paragraph 6-3.5 through 6-3.5.4 of 2.10; ensure brushes have a surface contact of 100 percent and are not chipped, cracked, or broken; remove sand, carbon, and other foreign matter resulting from fitting new brushes; adjust spring tension of brushes in accordance with 2.2. Adjust air gap as specified in 2.2, plus or minus 10 percent. Rotate shaft by hand a minimum of 3 revolutions. Rubbing or binding of rotating assembly must not be allowed. Record data in Attachment C or equivalent form that contains the requirements of Attachment C.

3.18.1 Install label plates conforming to MIL-DTL-15024 for those identified to be missing or damaged.

3.18.2 Inspect equipment for applicable electromagnetic interference (EMI) fixes using Shipboard Electromagnetic Compatibility Improvement Program (SEMCIP) Technical Assistance Network (STAN) in accordance with 2.12. Record data in Attachment B-1 or equivalent form that contains the requirements of Attachment B-1.

3.19 Accomplish a no-load shop test of the equipment for a minimum of one-half hour. Verify proper direction of rotation. After one-half hour, measure current and voltage in each phase, speed and bearing temperature rise measured on the equipment's exterior near each bearing. Record data in Attachment B-1 or equivalent form that contains the requirements of Attachment B-1.

3.20 Accomplish an operational test, of the assembled vaneaxial/tubeaxial fan, for one hour after bearing and stator temperatures stabilize within one degree Celsius for 3 consecutive 15-minute intervals. Verify proper direction of rotation. Measure current, voltage, frame and bearing temperature rise and speed at 15-minute intervals. Bearing temperatures must not exceed 180 degrees Fahrenheit, unless otherwise specified in the invoking Work Item or equipment technical manual. Measure hot insulation resistances of winding to ground immediately upon completion of the operational shop test, using a 500-volt megger. Record data in Attachment B-1 or equivalent form that contains the requirements of Attachment B-1.

3.21 Submit one legible copy, in approved transferrable media, of a report listing results of the requirements of 3.1.1, 3.1.2, 3.2, 3.3.1 through 3.3.2.1, 3.3.5 through 3.3.7, 3.5.1, 3.5.3 through 3.5.5, 3.6.1 through 3.6.4, 3.9, 3.10, 3.11, 3.17.1.5, 3.18, 3.19, and 3.20 to the SUPERVISOR.

3.22 Install equipment. Install new gaskets conforming to MIL-PRF-900 on disturbed ventilation. Align in accordance with 2.2. Measure facial and peripheral coupling data. Install chocks, shims, shock mounts, sound damping pads, and other accessories. Connect electrical cables/wiring. Bond and ground equipment in accordance with 2.11, using new ground



straps. Rotate shaft by hand a minimum of 3 revolutions. Rubbing or binding of rotating assembly must not be allowed. Measure the air gap and bearing clearance (sleeve bearing equipment only), insulation resistance (at 500 volts DC), and thrust. Record data in Attachment B-2 and C or equivalent form that contains the requirements of Attachment B-2 and C.

3.22.1 Accomplishment of pump and driver shaft alignment must be in accordance with NAVSEA Standard Items. (See 4.8)

(V)(G) "OPERATIONAL TEST"

3.23 Accomplish an operational test of the assembled equipment at full system capacity for one hour after bearing and stator temperatures stabilize within one degree Celsius for 3 consecutive 15-minute intervals, unless otherwise specified in the invoking Work Item. When temperatures do not stabilize in four hours, stop test and contact the SUPERVISOR. Verify proper direction of rotation. Verify/establish oxide film coating of the commutator/collector rings, using 2.10 for guidance. Measure current, voltage, frame and bearing temperature rise, and speed at 15-minute intervals. Frame and bearing temperature rise and speed is not required for vaneaxial and tubeaxial fan assemblies. Bearing temperatures must not exceed 180 degrees Fahrenheit, unless otherwise specified in the invoking Work Item or equipment technical manual. Record data in Attachment B-2 or equivalent form that contains the requirements of Attachment B-2.

3.23.1 Accomplish the requirements of 3.23 twice for two speed motors, once while operating at low speed, and once while operating at high speed. Record data in Attachment B-2 or equivalent form that contains the requirements of Attachment B-2.

3.23.2 Accomplish the requirements of 3.23 for limited duty motors, for a period of time equal to the duty cycle of the motor. For motors with a duty cycle equal to or less than 30 minutes, measure data every 10 minutes. Record data in Attachment B-2 or equivalent form that contains the requirements of Attachment B-2.

3.23.3 Measure hot insulation resistances of windings to ground immediately upon completion of test, using a 500-volt megger. Record data in Attachment B-2 or equivalent form that contains the requirements of Attachment B-2.

3.24 Submit one legible copy, in hard copy or approved transferrable media, of a report listing data recorded in 3.1.1, 3.1.2, 3.2, 3.22 and 3.23 through 3.23.3 to the SUPERVISOR.

#### 4. NOTES:

4.1 Equipment technical manual, Allowance Parts List (APL) (if applicable) and drawings will be listed in the invoking Work Item.

4.2 Shop test of generator will be addressed in the invoking Work Item.

4.3 Utilize Attachment A for determination if the Navy's motor bearing conversion program for Extended Life Double Seal (ELDS) ball bearings is permissible.

4.4 Data received in 3.17.1.5 must be forwarded to the SUPERVISOR for the purpose of initiating action ensuring shipboard databases such as the Equipment Guidance List (EGL) are updated to reflect the change in maintenance requirements for converted motors. Additionally, where APL changes are initiated to convert to ELDS bearings, a COSAL feedback report will be submitted, providing the NSN and part number for the ELDS bearing. The following website to initiate changes to Technical Manuals, APLs, etc.: <http://www.navy311.navy.mil>.

4.5 MIL-B-17931 (Bearings, Ball, Annular, For Quiet Operation) bearings are considered to be Long Lead Time (LLT) material. It is recommended these bearings be provided as Government Furnished Material (GFM).

4.6 If balancing of rotating equipment of 3.12 is required; the use of Category II Standard Item 009-15 "Rotating Machinery; balance" of 2.1 will be specified in the Work Item.

4.7 If cleaning and painting of 3.2.1, 3.3.4, or 3.16.1 is required; the use of Category II Standard Item 009-32 "Cleaning and Painting Requirements; accomplish" of 2.1 will be specified in the Work Item.

4.8 If pump and driver shaft alignment of 3.22.1 is required; the use of Category II Standard Item 009-58 "Pump and Driver Shaft Alignment; accomplish" of 2.1 will be specified in the Work Item.

4.9 Shipboard Electromagnetic Compatibility Improvement Program (SEMCIP) Technical Assistance Network (STAN) referred to in 3.18.2 is available at <https://semcip.nswc.navy.mil/stan/modules/stan/default.asp>.

4.10 If having difficulty determining motor Service Class, utilize 2.13 for guidance.

## ATTACHMENT A

1. To reduce motor maintenance and repair costs, the NAVY has implemented a program that allows for the use of Extended Life Double Seal (ELDS) bearings.

2. LIMITATIONS: The ELDS program does NOT apply to motors that are under the cognizance of NAVSEA 08.

3. APLs for motors meeting the conversion criteria requirements have been modified to identify ELDS bearings. In these cases, the APL bearing criteria will override any specifications delineated in the equipment technical manual or the motor "Original Equipment Manufacturer (OEM)" drawings. If ELDS bearings are not indicated in an APL, the following motor criteria must meet the applicability specifications for motors to undergo conversion to ELDS bearings:

3.a Motor must be installed on a surface ship and must NOT be under the cognizance of NAVSEA 08.

3.b Commercial motors are not eligible. Motors must have been furnished to the NAVY in accordance with MIL-DTL-17060 (Motors, Alternating Current, Integral Horsepower, Shipboard use), MIL-M-17413 (Motors, Direct Current, Integral H.P., Naval Shipboard [NAVY]) or MIL-M-17059 (Motors, 60 Cycle, Alternating Current Fractional H.P. [Shipboard Use]).

3.c Motors using one or more noise-quiet bearings per MIL-B-17931 (Bearings, Ball, Annular, For Quiet Operation) are NOT eligible for ELDS conversion.

3.d Bearings originally furnished with the motor must be type 111 bearings per FF-B-171. Motors are NOT to be considered as candidates for ELDS conversion in situations where the equipment technical manual and/or the OEM motor drawings originally specified FF-B-171 bearings but have notes indicating that replacement bearings are to be in accordance with MIL-B-17931 (Bearings, Ball, Annular, For Quiet Operation).

3.e The use of ELDS bearings is limited to motors where the full load speed and the size of both bearings are as follows:

1. Maximum bearing size 306 or 206 and full load rpm between 1,801 and 3,600 rpm.
2. Maximum bearing size 313 or 213 and full load rpm between 1,201 and 1,800 rpm.
3. Maximum bearing size 318 or 218 and full load rpm less than 1200 rpm.

4. The repair process using ELDS bearings includes the following requirements:

4.a Only ELDS bearings, in accordance with the following table (Attachment A / Table 1), can be used. Other double seal bearings will not provide an acceptable bearing life.

Attachment A / Table 1  
ELDS Bearings NSNs and Part Numbers

SIZE	P/N	NSN
201	6201-2RS1C3/GHY	3110-01-492-0221
202	6202-2RS1C3/GHY	3110-01-491-0233
203	6203-2RS1C3/GHY	3110-01-491-0234
204	6204-2RS1C3/GHY	3110-01-491-6636
205	6205-2RS1C3/GHY	3110-01-451-9166
206	6206-2RS1C3/GHY	3110-01-451-9165
207	6207-2RS1C3/GHY	3110-01-451-9164
208	6208-2RS1C3/GHY	3110-01-451-9170
209	6209-2RS1C3/GHY	3110-01-451-9252
210	6210-2RS1C3/GHY	3110-01-492-1831
211	6211-2RS1C3/GHY	3110-01-518-0937
303	6303-2RS1C3/GHY	3110-01-493-3750
304	6304-2RS1C3/GHY	3110-01-451-9153
305	6305-2RS1C3/GHY	3110-01-451-9158
306	6306-2RS1C3/GHY	3110-01-451-9159
607	6307-2RS1C3/GHY	3110-01-451-9161
308	6308-2RS1C3/GHY	3110-01-451-9167
309	6309-2RS1C3/GHY	3110-01-451-9168
310	6310-2RS1C3/GHY	3110-01-490-6683
311	6311-2RS1C3/GHY	3110-01-492-0223
312	6312-2RS1C3/GHY	3110-01-490-6848
313	6313-2RS1C3/GHY	3110-01-492-0191
314	6314-2RS1C3/GHY	3110-01-492-0226
315	6315-2RS1C3/GHY	3110-01-494-0993
316	6316-2RS1C3/GHY	3110-01-492-0188
317	6317-2RS1C3/GHY	3110-01-492-0219
318	6318-2RS1C3/GHY	3110-01-493-3749

4.b Both bearings of each converted motor must be ELDS bearings.

4.c A label plate must be permanently attached to the motor indicating "Do Not Lubricate".

4.d Grease fills and drains, if present, must be fitted with a pipe plug, securely fastened. Fittings to accommodate grease guns must be replaced with pipe plugs."

ATTACHMENT B-1

Ship name:

Hull number:

Work item number:

Date:

Motor nameplate data.

Manufacture:

Amperage (AMP):

Model number:

Horsepower (HP):

NSN:

Revolutions per minute (RPM):

S/N:

Winding (WDG):

Frame:

Maximum ambient temperature (AMB):

Volt:

Insulation class:

Phase:

Duty:

Hertz (HZ):

Drawing number (DWG):

Field changes:

Additional nameplate data:

ATTACHMENT B-1

3.3.1 Core Loss test.

SAT		UNSAT	
Test equipment:			
Findings:			

3.3.1.1 Loop test.

SAT		UNSAT	
Test Equipment:			
Findings:			

3.3.2 Core temperature limitations and winding data.

Core temperature limitations:		°F
As found winding data:		
Manufacture winding data:		

3.3.2.1 Post winding removal core loss and loop test.

- Core Loss test.

SAT		UNSAT	
Test equipment:			
Findings:			

ATTACHMENT B-1

- Loop test.

SAT		UNSAT	
Test Equipment:			
Findings:			

3.3.5 Rotor inspection.

- Non-wound rotor inspection.

SAT		UNSAT	
Findings:			

- Wound rotor inspection.

SAT		UNSAT	
Findings:			

3.3.7 Commutator pre-installation and post-installation test.

Pre-installation	Acceptance Criteria	Measured	SAT	UNSAT
	MΩ	MΩ		
	MΩ	MΩ		
Post-installation				
	MΩ	MΩ		
	MΩ	MΩ		
Findings:				

ATTACHMENT B-1

3.5.1 500-volt megger insulation resistance test.

Lead	Acceptance Criteria	Measured	SAT	UNSAT
	MΩ	MΩ		
	MΩ	MΩ		
	MΩ	MΩ		
Findings:				

3.5.3 Phase resistance balance test.

Phase	Acceptance Criteria	Measured	SAT	UNSAT
	Ω	Ω		
	Ω	Ω		
	Ω	Ω		
Findings:				

3.5.4 Voltage surge test.

Circuit Tested	Test Voltage	Error Ratio	SAT	UNSAT
	V	%		
	V	%		
	V	%		
Findings:				

3.5.5 DC HI POT test.

Circuit Tested	Test Voltage	Leakage Current	SAT	UNSAT
	V	uA		
	V	uA		
	V	uA		
Findings:				

3.6.1 Post winding permanent connection.

- 500-volt megger insulation resistance test.

Lead	Acceptance Criteria	Measured	SAT	UNSAT
	MΩ	MΩ		
	MΩ	MΩ		
	MΩ	MΩ		
Findings:				



ATTACHMENT B-1

- Phase resistance balance test.

Phase	Acceptance Criteria	Measured	SAT	UNSAT
	$\Omega$	$\Omega$		
	$\Omega$	$\Omega$		
	$\Omega$	$\Omega$		
Findings:				

- Voltage surge test.

Circuit Tested	Test Voltage	Error Ratio	SAT	UNSAT
	V	%		
	V	%		
	V	%		
Findings:				

- DC HI POT test.

Circuit Tested	Test Voltage	Leakage Current	SAT	UNSAT
	V	uA		
	V	uA		
	V	uA		
Findings:				

3.6.2 DC bar-to-bar test.

Circuit Tested	Acceptance Criteria	Measured	SAT	UNSAT
	$\Omega$	$\Omega$		
	$\Omega$	$\Omega$		
Findings:				

3.6.3 Polarization index test.

Circuit Tested	One Minute	10 Minute	PI Ratio	SAT	UNSAT
	M $\Omega$	M $\Omega$			
	M $\Omega$	M $\Omega$			
	M $\Omega$	M $\Omega$			
Findings:					

ATTACHMENT B-1

3.9 Post Varnish and bake

- 500-volt megger insulation resistance test.

Lead	Acceptance Criteria	Measured	SAT	UNSAT
	MΩ	MΩ		
	MΩ	MΩ		
	MΩ	MΩ		
Findings:				

- Phase resistance balance test.

Phase	Acceptance Criteria	Measured	SAT	UNSAT
	Ω	Ω		
	Ω	Ω		
	Ω	Ω		
Findings:				

- Voltage surge test.

Circuit Tested	Test Voltage	Error Ratio	SAT	UNSAT
	V	%		
	V	%		
	V	%		
Findings:				

- DC HI POT test.

Circuit Tested	Test Voltage	Leakage Current	SAT	UNSAT
	V	uA		
	V	uA		
	V	uA		
Findings:				

3.10 AC HI POT test.

Circuit Tested	Test Voltage	Leakage Current	SAT	UNSAT
	V	mA		
	V	mA		
	V	mA		
Findings:				

ATTACHMENT B-1

3.11 Commutator or collector ring eccentricity.

SAT		UNSAT	
Findings:			

3.17.1.5 Maintenance requirement change for double seal bearing conversion.

Findings:	

3.18.2 Inspection for EMI fixes.

Findings:	

3.19 No-load shop test.

Direction of Rotation	CW		CCW	
Speed				RPM
Current			Volts	
T1	A	T1		V
T2	A	T2		V
T3	A	T3		V
Bearing Temperature				
Coupled End				°F
Free End				°F

ATTACHMENT B-1

3.20 Operational shop test of assembled vaneaxial/tubeaxial fan.

Direction of Rotation	CW		CCW	
Speed	RPM			
Current	Volts			
T1	A	T1	V	
T2	A	T2	V	
T3	A	T3	V	
Bearing Temperature				
Coupled End	°F			
Free End	°F			
500-volt megger insulation resistance test				
Lead	Acceptance Criteria	Measured	SAT	UNSAT
	MΩ	MΩ		
	MΩ	MΩ		
	MΩ	MΩ		

ATTACHMENT B-2

Ship name:

Hull number:

Work item number:

Date:

Motor nameplate data.

Manufacture:

Amperage (AMP):

Model number:

Horsepower (HP):

NSN:

Revolutions per minute (RPM):

S/N:

Winding (WDG):

Frame:

Maximum ambient temperature (AMB):

Volt:

Insulation class:

Phase:

Duty:

Hertz (HZ):

Drawing number (DWG):

Field changes:

Additional nameplate data:

ATTACHMENT B-2

3.1.1 Preliminary inspection.

SAT		UNSAT	
Findings:			

3.1.2 List of accessories.

Findings:	

3.2 Foundation structural inspection.

SAT		UNSAT	
Findings:			

3.22 Post installation 500-volt megger insulation resistance test.

Lead	Acceptance Criteria	Measured	SAT	UNSAT
	MΩ	MΩ		
	MΩ	MΩ		
	MΩ	MΩ		
Findings:				

ATTACHMENT B-2

3.23 Operational test of the assembled equipment at full system capacity.

Direction of Rotation	CW		CCW	
Speed				
	RPM			
15 Minutes				
Current		Volts		
T1	A	T1		V
T2	A	T2		V
T3	A	T3		V
Bearing Temperature				
Coupled End				°F
Free End				°F
30 Minutes				
Current		Volts		
T1	A	T1		V
T2	A	T2		V
T3	A	T3		V
Bearing Temperature				
Coupled End				°F
Free End				°F
45 Minutes				
Current		Volts		
T1	A	T1		V
T2	A	T2		V
T3	A	T3		V
Bearing Temperature				
Coupled End				°F
Free End				°F
One Hour				
Current		Volts		
T1	A	T1		V
T2	A	T2		V
T3	A	T3		V
Bearing Temperature				
Coupled End				°F
Free End				°F

ATTACHMENT B-2

3.23.1 Operational test of the assembled equipment at full system capacity, two speed motor.

Direction of Rotation	CW		CCW	
Speed	RPM			
15 Minutes				
Current		Volts		
T4	A	T4		V
T5	A	T5		V
T6	A	T6		V
Bearing Temperature				
Coupled End				°F
Free End				°F
30 Minutes				
Current		Volts		
T4	A	T4		V
T5	A	T5		V
T9	A	T6		V
Bearing Temperature				
Coupled End				°F
Free End				°F
45 Minutes				
Current		Volts		
T4	A	T4		V
T5	A	T5		V
T6	A	T6		V
Bearing Temperature				
Coupled End				°F
Free End				°F
One Hour				
Current		Volts		
T4	A	T4		V
T5	A	T5		V
T6	A	T6		V
Bearing Temperature				
Coupled End				°F
Free End				°F



ATTACHMENT B-2

3.23.2 Operational test of the assembled equipment at full system capacity, limited duty motor.

Direction of Rotation	CW		CCW	
Speed	RPM			
Duty Cycle or 10 Minutes as applicable.				
Current		Volts		
T1	A	T1	V	
T2	A	T2	V	
T3	A	T3	V	
Bearing Temperature				
Coupled End	°F			
Free End	°F			
20 Minutes as applicable.				
Current		Volts		
T1	A	T1	V	
T2	A	T2	V	
T3	A	T3	V	
Bearing Temperature				
Coupled End	°F			
Free End	°F			
30 Minutes as applicable.				
Current		Volts		
T1	A	T1	V	
T2	A	T2	V	
T3	A	T3	V	
Bearing Temperature				
Coupled End	°F			
Free End	°F			

3.23.3 Post installation 500-volt megger hot insulation resistance test.

Lead	Acceptance Criteria	Measured	SAT	UNSAT
	MΩ	MΩ		
	MΩ	MΩ		
	MΩ	MΩ		
Findings:				

ATTACHMENT C

SHIP NAME & HULL NUMBER

/ /  
MONTH/DAY/YEAR

MOTOR LOCATION (i.e., NO.2 MAIN FEED PUMP, etc.)

HOUSING DIAMETERS

<u>DRIVE END</u>			
	<u>A</u>	<u>B</u>	<u>C</u>
<u>1</u>			
<u>2</u>			
<u>3</u>			

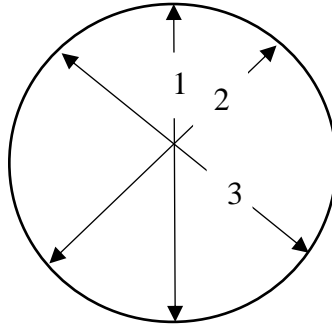

OUTER INNER

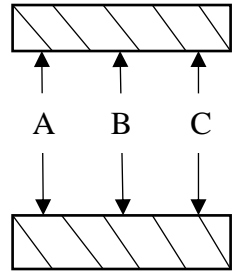

<u>OUTER END</u>			
	<u>A</u>	<u>B</u>	<u>C</u>
<u>1</u>			
<u>2</u>			
<u>3</u>			

SHAFT DIAMETERS

<u>DRIVE END</u>				<u>OUTER END</u>		
	<u>A</u>	<u>B</u>	<u>C</u>	<u>A</u>	<u>B</u>	<u>C</u>
<u>1</u>						
<u>2</u>						
<u>3</u>						

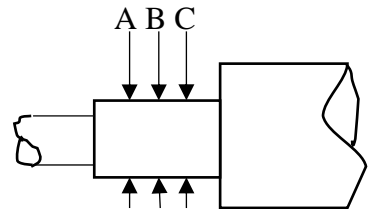
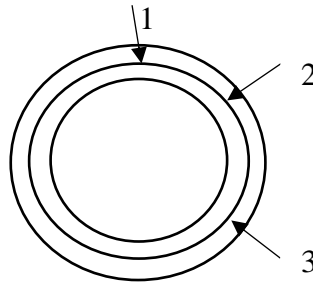

A. SHAFT RADIAL RUNOUT \_\_\_\_\_

B. FACE RUNOUT, BEARING INNER RING

DRIVE END \_\_\_\_\_

OUTER END \_\_\_\_\_

C. FACE RUNOUT, BEARING OUTER RING \_\_\_\_\_

DRIVE END \_\_\_\_\_

OUTER END \_\_\_\_\_

MECHANICAL CONDITION  
(LOSS OF LUBE, BURNED ETC.)

\_\_\_\_\_  
\_\_\_\_\_

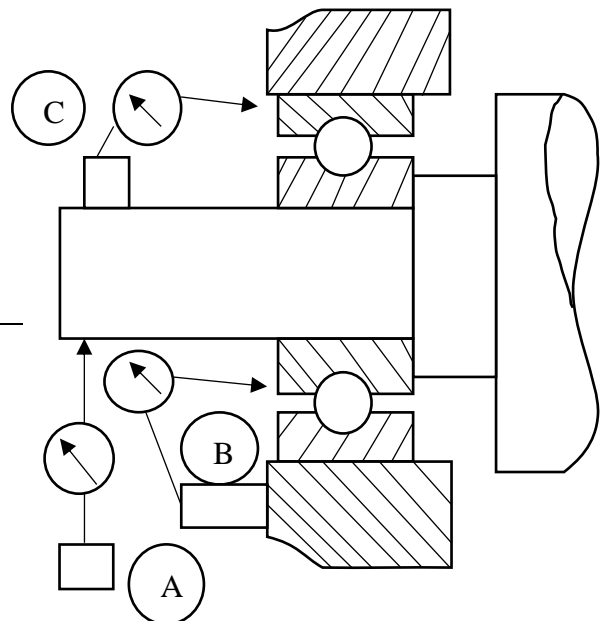

NAVSEA  
STANDARD ITEM

FY-24

ITEM NO: 009-34  
DATE: 25 OCT 2022  
CATEGORY: I

1. SCOPE:

1.1 Title: Fire Protection of Unmanned Vessel at Contractor Facility; accomplish

2. REFERENCES:

2.1 NFPA Standard 312, Standard for Fire Protection of Vessels During Construction, Repair, and Lay-up

2.2 29 CFR Part 1915, Occupational Safety and Health Standards for Shipyard Employment

3. REQUIREMENTS:

3.1 Accomplish fire protection for an unmanned vessel at a contractor facility in accordance with the requirements of 2.1 and 2.2 and this item.

3.2 Maintain available for review, prior to commencement of work, a fire safety plan meeting the requirements of 2.2. In addition to the requirements of 2.2, the plan must include and identify the method for reporting fires, the firefighting equipment, and organization (paid or volunteer), the procedures for maintenance of clear fire lanes, and the nearest municipal firefighting organization, including the anticipated time of response.

3.3 Provide fire protection equipment consisting of:

3.3.1 Firefighting water, utilizing manifolds connected to a source capable of providing 150 GPM at 60 PSIG at the manifold must be in place before start of work.

3.3.1.1 The number of manifolds must be sufficient to permit reaching all points on the vessel (including underwater body when the vessel is in dry dock or on a marine railway) with 2, 1-1/2 inch hoses of not more than 100 feet in length.

3.3.1.2 Hoses must be attached to the manifolds and fitted with an all-purpose combination fog and straight stream nozzle.

3.3.1.3 Verify by the Pitot tube method or an in-line flow meter that the water volume and pressure meets these requirements.

3.4 Ensure access to temporary and Ship's Force firefighting equipment is not obstructed or restricted.

3.5 For Navy boats and craft the SUPERVISOR may waive the requirements of 3.3. If authorized by the SUPERVISOR, a portable fire extinguisher (or an equivalent means for fighting a fire) in the immediate vicinity of where the work is performed can be used in lieu of fire main.

4. NOTES:

4.1 The term "unmanned" is defined as without the physical presence of people in control; without a human operator.

NAVSEA  
STANDARD ITEM

FY-24

ITEM NO: 009-36  
DATE: 25 OCT 2022  
CATEGORY: II

1. SCOPE:

1.1 Title: Controller; repair

2. REFERENCES:

2.1 Standard Items

2.2 Equipment Technical Manual

2.3 S9086-KC-STM-010/CH-300, Electric Plant - General

2.4 MIL-STD-2003, Electric Plant Installation Standard Methods for Surface Ships and Submarines

2.5 MIL-STD-1310, Shipboard Bonding, Grounding, and Other Techniques for Electromagnetic Compatibility, Electromagnetic Pulse (EMP) Mitigation, and Safety

3. REQUIREMENTS:

3.1 Disconnect mechanically and remove each controller.

3.1.1 Matchmark, identify, and retain shims and other accessories associated with the equipment.

3.2 Inspect each foundation for cracks, areas of distortion, and deterioration in excess of 25 percent of the thickness of each member of the structure. Record results.

3.3 Accomplishment of cleaning and painting for foundations of equipment removed in 3.1 must be in accordance with NAVSEA Standard Items (See Note 4.2).

3.4 Disassemble each controller and clean components free of foreign matter.

3.5 Inspect each controller enclosure, mounting board, electrical and mechanical component, internal wiring, and hardware for conformance to 2.2 and controller wiring diagram, and determine any missing and defective components and wiring. Record results. Record and retain electrical hook-up data.

3.5.1 Test internal wiring and each coil for open circuits. Test insulation resistance to ground and between conductors, using a 500-volt megger. Record readings. Minimum acceptable resistance to ground must be one megohm.

3.5.1.1 Disconnect solid-state devices prior to measuring insulation resistance.

3.6 Submit one legible copy, in approved transferrable media, of a report listing retained accessories in 3.1.1 and results of the requirements of 3.2, 3.5 and 3.5.1 to the SUPERVISOR.

3.7 Repair each controller, using 2.2 for guidance.

3.7.1 Straighten each enclosure and door. Free-up hinges and align door. Plug and seal unused cable openings. Remove existing enclosure gaskets, molded-rubber switch covers, and ground straps.

3.7.2 Accomplishment of cleaning and painting of the interior and exterior of the enclosure must be in accordance with NAVSEA Standard Items (See Note 4.2).

3.7.3 Install new enclosure gaskets and install new molded-rubber switch covers per equipment specification.

3.7.4 Install ground straps on each door on controllers with door mounted energized components in accordance with MIL-DTL-2036 in place of those identified to be missing or defective.

3.7.5 Remove existing and install new components in place of those identified to be missing, defective or of improper value. Remove existing and install new wiring in place of wiring identified to be defective or frayed. Install new wiring where missing.

3.7.6 Dress, and adjust contacts.

3.7.6.1 Resilver existing contacts in accordance with ASTM B 700.

3.7.7 Remove existing cadmium-plated parts and install new zinc-plated parts in accordance with ASTM A 153.

3.7.8 Wash, dip and bake, tape insulated coils and open transformers. Dipping must be in varnish conforming to MIL-I-24092, Class 155.

3.7.8.1 Dip and bake coils and open transformers in Dolph 1105, Epoxylite Esterlite 605, or Schenectady International Isolite 862M varnish in localities where MIL-I-24092 varnish does not meet state and local Air Pollution Control District (APCD) Standards.

3.7.8.2 Repair and reinsulate coil and transformer leads.

3.7.9 Free-up and lubricate moving parts.

3.7.10 Adjust timing devices, relays, and contactors.

3.7.11 Repair defective connections.

3.7.12 Install a new wiring diagram and new heater table in each controller. The new diagram must reflect actual configuration of the controller in which it is installed. New diagrams must be sealed in transparent plastic and must be mounted on the inside of each controller so as to be conveniently accessible.

3.8 Assemble each controller.

3.8.1 Dress and shape wiring and wire harnesses for neat appearance. Install wire clamps on both ends of wire hinges. Install flexible insulating tubing over wire hinges to prevent chafing.

3.9 Accomplish 500-volt megger insulation resistance test, using Paragraphs 300-3.2.2 through 300-3.2.3, 300-3.4.7, 300-3.4.10, and 300-5.3.7.1 of 2.3 for guidance. Record readings.

3.10 Connect internal wiring and solid-state devices.

3.11 Accomplish an operational test of each controller and adjust to ensure correct operation in accordance with the wiring diagram of 3.7.11, using 2.2 for guidance. Record results.

3.12 Submit one legible copy, in approved transferrable media, of a report listing results of the requirements of 3.9, 3.11, and a list of new components and wiring installed to the SUPERVISOR.

3.13 Install each controller using shims and other accessories retained in 3.1.1.

3.13.1 Remove existing and install new conductor identification sleeving in place of conductor identification sleeving identified to be illegible or missing. New conductor identification sleeving must conform to SAE-AMS-DTL-23053, Class One, white, marked with indelible ink.

3.13.2 Repair and reinsulate cable ends terminating in the controller in accordance with Part One of 2.4. Resleeve conductors over 9,000 circular mils.

3.13.3 Remove defective and install new lugs, using 2.3 for accept or reject criteria. Install new lugs where missing. New lugs must conform to MIL-T-16366 or SAE-AS7928.

3.13.4 Bond and ground equipment in accordance with 2.5.

3.14 Connect each controller with the exception of the motor leads and the brake leads if applicable, using retained data of 3.1.

(V) "PRELIMINARY SEQUENCE TEST"

3.14.1 Accomplish a preliminary sequence test of each controller by cycling the controller through 3 start and stop cycles from each local and remote pushbutton station. Observe controller for proper sequence. Correct deficiencies.

3.14.2 Connect the motor leads and brake leads, if applicable, at completion of preliminary sequence test.

(V)(G) "OPERATIONAL TEST"

3.15 Accomplish an operational test of each controller with its associated motor for designed sequence of operation. Verify correct speed selection, correct motor rotation in each mode, and correct value of overload setting or size of heater coils based on motor nameplate full load running current.

4. NOTES:

4.1 Equipment technical manual and drawings will be listed in the invoking Work Item.

4.2 If cleaning and painting of 3.3 or 3.7.2 is required; the use of Category II Standard Item 009-32 "Cleaning and Painting Requirements; accomplish" of 2.1 will be specified in the Work Item.



NAVSEA  
STANDARD ITEM

FY-24

ITEM NO: 009-37  
DATE: 25 OCT 2022  
CATEGORY: II

1. SCOPE:

1.1 Title: General Procedure for Woodwork; accomplish

2. REFERENCES:

2.1 Standard Items

2.2 0900-LP-015-1010, Wood: A Manual for Its Use as a Shipbuilding Material, Basic Wood Technology Applicable to Boat and Shipbuilding

2.3 0900-LP-015-1020, Wood: A Manual for Its Use as a Shipbuilding Material, Techniques and Practices Applicable to Preservation and Storage

2.4 0900-LP-015-1030, Wood: A Manual for Its Use as a Shipbuilding Material, Technical Data Applicable to Boat and Ship Design

2.5 0900-LP-015-1040, Wood: A Manual for Its Use as a Shipbuilding Material, Boat and Ship Construction Techniques

2.6 MIL-STD-1623, Fire Performance Requirements and Approved Specifications for Interior Finish Materials and Furnishings (Navy Shipboard Use)

3. REQUIREMENTS:

3.1 Accomplish the requirements of 2.2 through 2.5 for performing general woodworking procedures.

3.2 Install flush fitted wood plugs/dowels in holes resulting from the removal of fasteners.

3.2.1 Drill out holes to sound wood and install plugs/dowels. Plugs/dowels must be set in a commercial grade phenol and resorcinol resin base adhesive.

3.2.2 Where deterioration and decay exists around the perimeter of the fastener holes and where through-bolt holes have been elongated, enlarge the holes by drilling to a size (diameter) that will remove the deterioration, decay, and elongation, prior to installing plugs/dowels.

3.2.2.1 Clean-bore drill bit diameter must not be more than one inch larger than the original fastener hole diameter, unless otherwise specified.

3.2.3 Plugs/dowels must be of the same wood species as the member being repaired, with their grain installed parallel with the grain of the existing wood, and then driven the full depth of the hole being repaired.

3.2.4 Soak plugs/dowels for a minimum of 10 minutes and saturate the exposed fastener holes with copper naphthenate wood preservative applied in accordance with manufacturer's instructions, and allow to dry to a moisture content of 15 percent or less prior to installation of plugs/dowels.

3.3 Install new fasteners in accordance with NAVSEA Standard Items 2.1. (See Note 4.2)

3.3.1 Aluminum and aluminum alloy components and structural members must be installed using CRES, Grade 304 or 316 fasteners.

3.3.1.1 Fasteners with compositions of copper alloys must not be used in contact with aluminum and aluminum alloy components and structural members.

3.3.1.2 Install non-metallic (epoxy plastic, phenolic, polyimide [nylon], Teflon) sleeves over CRES fasteners where they come in contact with the aluminum and aluminum alloy components and structural members.

3.3.1.3 Install insulation tape, minimum thickness 20 mils, conforming to MIL-I-24391 (2 thicknesses) between faying surfaces of aluminum/aluminum alloy-to-CRES to extend approximately 1/4-inch beyond the faying surfaces.

3.3.1.4 Ensure that the surfaces of aluminum and aluminum alloy components and structural members which will come in contact with wood members and CRES fasteners are protected with a minimum of 2 coats of epoxy polyimide primer conforming to MIL-PRF-23236.

3.3.1.5 Apply one coat of phenolic modified clear varnish on wood members which will come in contact with aluminum and aluminum alloy components and structural members. Refer to the Master Painters Institute (MPI) Approved Product List, MPI #28, for procurement of exterior marine spar varnish.

3.3.2 To avoid bi-metallic corrosion, fastener material composition must be the same material composition as that of the metal components and structural members that they are fastening except as noted in 3.3.1.

3.4 Accomplish installation of new fasteners as follows:

3.4.1 Drill pre-bored pilot holes for screws and fether ring nails prior to installation to prevent damage to wood members.

3.4.1.1 Diameter of pilot holes must not exceed 70 percent of the root diameter of screws for soft woods, and 90 percent for hard woods. For screw shanks, the hole in the material to be fastened must be 100 percent shank diameter.

3.4.1.2 Maximum depth of pilot holes must not exceed 90 percent of the length of screws.

3.4.1.3 Holes for fether ring nails must be pre-bored not to exceed 60 percent of the nail diameter.

3.4.2 Screws must not be impact driven. The last ¼-inch of screws must be hand-tightened.

3.4.2.1 Fasteners must be set snug but not so tight as to weaken the material by rupture of wood fibers adjacent to the fasteners.

3.4.3 Bolt holes must be drilled for a tight fit.

3.4.4 Where watertight integrity must be maintained, the fasteners must be body bound.

3.4.5 Through-bolts and hull plank fasteners must be bedded in marine oakum conforming to T-O-56 or caulking cotton, and a NAVSEA approved natural bedding compound such as Interlux 214 or Dolchem 3400.

3.4.6 Counterbore wood fastener holes to permit the installation of a wood plug (bung) over the fasteners, unless otherwise specified. Install wood plugs over fasteners.

3.4.6.1 The depth of counterboring is fixed by the thickness of the planking, which in turn fixes the depth of the wood plug (bung) used. The depth (thickness) of a bung plug must be one-half to two-thirds its diameter to ensure that it will stay in place. The rule for counterboring for bung plugs is that the plug diameter must be no larger than necessary to allow the largest part of the fastener to enter the hole.

3.4.6.2 Plugs must be of the same wood species as the member being plugged and their grain must be installed parallel with the grain of the existing wood.

3.4.6.3 Soak plugs for a minimum of 10 minutes and saturate the fastener holes with wood preservative conforming to copper naphthenate, applied in accordance with manufacturer's instructions, and allow to dry for a minimum of 4 days prior to installation of plugs.

3.4.6.4 Coat plugs on faying surfaces with a NAVSEA approved natural bedding compound such as Interlux 214 or Dolchem 3400, prior to installation and cut level and smooth with surrounding surfaces, unless otherwise specified.

3.5 New wood materials must conform to the following requirements, unless otherwise specified.

3.5.1 Wood materials used for new interior finish materials and furnishings must conform to the requirements of MIL-L-19140 and 2.6.

3.5.2 Types, grades, and species of wood (lumber) must be as specified in the invoking Work Item.

3.5.3 Lumber must conform to the specified grade after seasoning to the required moisture content and after being sized to the approximate dimensions of the members to be fashioned from it.

3.5.4 New wood members must be finished smooth on each side.

3.5.5 Uncaulked seams, joints, and faying surfaces must be fair and in continuous contact when assembled, except where specifically exempted, such as for hull sheathing.

3.5.6 New wood members, when assembled in place, must show no rupture as a result of overstraining.

3.5.7 Laminated member construction must conform to MIL-W-15154 for red or white oak.

3.5.7.1 When bonding together wood surfaces which rely on mechanical fastening for main strength, commercial grade phenol and resorcinol resin base adhesive must be used.

3.5.8 Plywood must conform to MIL-P-18066, Class 3A.

3.5.9 Moisture content of new wood materials must fall within the following parameters.

3.5.9.1 New lumber must have a moisture content of 13 percent, plus or minus 5 percent, at the time of installation.

3.5.9.2 New plywood must have a moisture content of 10 percent, plus or minus 5 percent, at the time of installation.

3.6 New lumber and plywood must be soaked for 10 minutes in wood preservative after boring, shaping, and fairing operations have been completed.

3.6.1 Apply one soaking brush coat of wood preservative on bare wood surfaces exposed by removals and machining operations before surfaces are covered.

3.6.2 Wood preservative must conform to copper naphthenate, applied in accordance with manufacturer's instructions, unless otherwise specified.

3.6.3 Allow preservative-treated wood to dry to a moisture content of 15 percent or less prior to gluing and/or painting operations.

3.7 Apply a heavy coating of a NAVSEA approved natural bedding compound such as Interlux 214 or Dolchem 3400 on the top surfaces of deck beams, frames headers, fillers, planking side of frames, deck beam ends, seams, and butts (except those to be caulked), and other faying (joining) surfaces before the faying surfaces are covered, except as follows: In between inner and outer layers of hull planking of crafts that do not have caulking seams, a wood bedding/sealant compound conforming to 3M-5200 must be installed.

3.7.1 Install one layer of canvas conforming to PIA-C-419, Type III (8 ounces or heavier) between faying surfaces of new leveling foundation pads installed on weather decks, in addition to a NAVSEA approved natural bedding compound such as Interlux 214 or Dolchem 3400.

3.7.2 Remove surplus bedding/sealing compound after squeeze-out.

3.8 No new butt joints must be established in any planking strake (hull shell or deck) that will leave a portion that is less than 12 feet in length. No new portion of a planking strake must be installed which is less than 12 feet in length.

3.8.1 Butt joints in adjacent strakes must be separated by a minimum of 3 strakes.

3.8.2 Butt joints in the same frame space must be separated by a minimum of 3 frame spaces.

3.8.3 Planking strakes may be scarf-joined to maintain butt joint schedule. Scarfing must be in accordance with 2.2 through 2.5.

3.9 Wood members requiring caulking seams must be installed with their faying surfaces tight and with an outgauge (special bevel for caulking) in the side(s) to be caulked.

3.10 Accomplish the following work to ensure watertight integrity of caulked seams (including butt and rabbet seams).

3.10.1 Reef out by hand, defective caulking compound and loose and decayed caulking (cotton/oakum) from existing caulking seams requiring installation of new caulking and caulking compound.

3.10.1.1 Exercise care when reefing out caulking compound and caulking to preclude damage to existing caulking seams. Power tools must not be utilized for the reefing out process.

3.10.2 Where existing caulking is identified to be sound and in good condition, set the existing caulking deeper into the seam opening to ensure that it is driven solidly home and to make room for additional caulking.

3.10.2.1 Set the existing caulking by driving the caulking uniformly, to the same hardness in each seam. To prevent a wedging effect it must be set to a hardness that would not allow an awl to penetrate more than 3/8-inch.

3.10.3 Caulking seams must be clean and dry before installing new caulking and caulking compound.

3.10.4 Caulk deck planking caulking seams using treated caulking cotton and spun-type marine oakum conforming to T-O-56. Treat the caulking cotton as follows.

3.10.4.1 The untreated caulking cotton must be undyed, of not less than 3/4-inch staple length, and must be free from oil, fire-damaged or scorched cotton, added waste, and substantially free from linters.

3.10.4.2 The untreated caulking cotton must be soft and fully opened and contain no sizing. The amount or size of specks must not be objectionably noticeable upon casual examination.

3.10.4.3 The untreated caulking cotton must be well carded to form a sliver and must consist of not less than 9 nor more than 12 slivers laid parallel to form a composite untwisted strand. Each sliver untreated must measure approximately 500, plus or minus 50 feet, to the pound.

3.10.4.4 Treat the caulking cotton with a solvent solution of copper naphthenate-asphaltum to produce caulking cotton having a minimum of one percent metallic copper and 1-1/2 percent, plus or minus 1/2 percent, asphalt, based on the weight of the treated cotton. The copper must be uniformly distributed throughout the cotton.

3.10.4.5 The treated caulking cotton must be dry to the touch prior to installation.

3.10.5 Caulk hull shell planking caulking seams using treated caulking cotton conforming to the requirements outlined in 3.10.4.1 through 3.10.4.5 and spun-type marine oakum conforming to T-O-56.

3.10.5.1 Drive one to 2 strands of caulking cotton into the bottom of the seams, prior to installing marine oakum, to ensure that deep/tight seams are filled.

3.10.6 Caulking cotton and marine oakum caulking must be looped, tucked, and hard-driven to a depth that provides space for installation of seam caulking compound.

3.10.6.1 The size of the seam in width and depth determines the required amount of cotton/oakum caulking and must be filled to within 1/4-inch to 3/8-inch of the plank surface.

3.10.6.2 The amount of cotton/oakum caulking inserted must be carefully controlled to limit the possibility to "caulk off" a plank from its frames if too much is driven in and forced beyond the outgauge level.

3.10.6.3 The cotton/oakum caulking must be driven uniformly, to the same hardness and depth in each seam, to prevent a wedging effect. It must be set to a hardness that would not allow an awl to penetrate more than 3/8-inch.

3.10.6.4 Butt caulking seams must be caulked ahead of adjoining longitudinal caulking seams to ensure that short ends of caulking will be locked in place.

3.10.6.5 The ends of sound existing caulking and new caulking must be drawn out and tapered so as to be married in a continuous bulk and then be installed as stated in 3.10.6 through 3.10.6.4.

3.10.6.6 Hull shell planking caulking seams of heavy planked ships must have the caulking set firmly home by means of a heavy horsing iron driven into the seams with a heavy mallet known as a beetle. This is a 2-man operation that requires one man to hold the long-handled horsing iron while the second man swings the horsing beetle. This operation ensures that the caulking will be well seated, will not work loose, and is the final means to stiffen the hull.

3.10.7 Pay (fill) deck planking caulking seams with polyurethane caulking compound as specified in the invoking Work Item.

3.10.7.1 The depth of the seam caulking compound must be one to 1-1/2 times the width of the seam but no deeper than 3/8-inch.

3.10.7.2 Seal the surfaces of the seams and the installed cotton caulking with a seam primer that is compatible with the caulking compound.

3.10.7.3 Install one-inch wide masking tape on both sides of each caulking seam to keep the caulking compound from penetrating the open grain areas of the deck planking.

3.10.7.4 Remove the tape installed in 3.10.7.3 upon completion of caulking operations.

3.10.8 Pay hull shell planking caulking seams with caulking compound in accordance with the following requirements.

3.10.8.1 Pay underwater hull caulking seams with Interlux 30 brown underwater seam compound (oleoresinous material cut with an aromatic solvent).

3.10.8.2 Pay hull caulking seams above the waterline with Interlux 31 white seam compound (oleoresinous material cut with an aromatic solvent).

3.10.8.3 The depth of the seam caulking compound must be one to 1-1/2 times the width of the seam.

3.10.8.4 Paint the surfaces of the seams and the installed cotton/oakum caulking with anti-fouling paint conforming to MIL-PRF-24647, Type II, Class 1, prior to filling underwater hull shell planking seams with caulking compound.

3.10.8.5 Seal the surfaces of the seams and the installed cotton/oakum caulking with a seam primer that is compatible with the caulking compound on hull shell planking seams existing above the waterline.

3.10.9 Prior to paying the caulking compound installed in 3.10.7 and 3.10.8, seams must be thoroughly cleared and cleaned of foreign matter.

3.10.9.1 The caulking compound may be applied with a caulking gun but must be handworked into the seams to eliminate air pockets and voids in the seams.

3.10.9.2 Remove surplus caulking compound from surrounding surfaces.

3.10.9.3 Pay and complete seams daily, leaving no exposed cotton/oakum caulking at the end of each work shift to ensure the cotton/oakum caulking remains dry and clean.

3.10.9.4 When installing caulking compound and its compatible primer, the manufacturer's instructions must be strictly adhered to. Seams greater than 1/2-inch width must be payed in 2 applications spaced 24 hours apart.

3.11 Blank openings resulting from removals and relocations, unless otherwise specified, in accordance with the following.

3.11.1 Blank deck planking as follows:

3.11.1.1 Route a 3/8-inch deep indentation on both the top and underside of the deck planking, centered over the area to be blanked.

3.11.1.2 The routed area must extend a minimum of 3 inches beyond the perimeter of the area to be blanked.

3.11.1.3 Fit and install a Douglas Fir insert in the area to be blanked.

3.11.1.4 Fit and install a 3/8-inch thick plywood insert in each routed-out indentation.



3.11.1.5 Bed faying surfaces of the inserts with a NAVSEA approved natural wood bedding compound such as Interlux 214 or Dolchem 3400, and secure with round head bolts to ensure watertight integrity. Remove surplus wood bedding compound left after squeeze-out.

3.11.2 Blank plywood bulkheads and plywood decks as follows:

3.11.2.1 Enlarge the hole to be blanked to a minimum of 4 inches square.

3.11.2.2 Install a fitted plywood insert in the resulting opening in the deck or bulkhead.

3.11.2.3 Install a plywood lap cover on one side of and centered over the area to be blanked. The lap cover must extend a minimum of 3 inches beyond the perimeter of the area to be blanked.

3.11.2.4 Bed faying surfaces of the insert and the lap cover in a NAVSEA approved natural wood bedding compound such as Interlux 214 or Dolchem 3400, and secure with round head bolts to ensure watertight integrity. Remove surplus wood bedding compound left after squeeze-out.

3.11.3 Blank double-sheathed bulkheads as follows:

3.11.3.1 Enlarge the opening in the inner sheathing to a minimum of 4 inches square.

3.11.3.2 Enlarge the opening in the outer sheathing to a size that extends a minimum of 3 inches beyond the perimeter of enlarged inner sheathing opening.

3.11.3.3 Install a fitted plywood insert in each opening. The plywood inserts must be the same thickness as the sheathing.

3.11.3.4 Install one layer of canvas conforming to PIA-C-419, Type III (8 ounces or heavier), between the 2 inserts, the same size as the larger insert.

3.11.3.5 Bed faying surfaces of the inserts and the canvas in a NAVSEA approved natural wood bedding compound such as Interlux 214 or Dolchem 3400, and secure with round head bolts to ensure watertight integrity. Remove surplus wood bedding compound left after squeeze-out.

3.11.4 Sand new plywood blanks and disturbed surfaces to fair in with surrounding areas.

3.11.4.1 Accomplishment of cleaning and painting for bulkhead sheathing sanded surfaces must be in accordance with NAVSEA Standard items (See Note 4.1).

4. NOTES:

4.1 If cleaning and painting for bulkhead sheathing sanded surfaces of 3.11.4.1 is required; the use of Category II Standard item 009-32 “Cleaning and Painting Requirements; accomplish” of 2.1 will be specified in the Work Item.

4.2 Existing screws removed per this Standard Item are to be replaced with new, all other fasteners will be replaced per NAVSEA Standard Items 009-84 Threaded Fastener Requirements; accomplish.

NAVSEA  
STANDARD ITEM

FY-24

ITEM NO: 009-38  
DATE: 25 OCT 2022  
CATEGORY: II

1. SCOPE:

1.1 Title: Boiler, Catapult Accumulator and Reboiler Dry Lay-up;  
accomplish

2. REFERENCES:

- 2.1 S9086-GY-STM-010/CH-221, Boilers
- 2.2 S9587-B1-MMA-010, Catapult Steam Support Systems for CV/CVN Class Ships
- 2.3 525-7270424, Steam Accumulator Dehumidification
- 2.4 0989-036-0000, CVN 68 Class Steam Plant Manual (CONFIDENTIAL)
- 2.5 S9534-AD-MMA-010, Steam Reboiler

3. REQUIREMENTS:

3.1 Boiler: Prepare boiler for dry lay-up in accordance with Paragraph 221-2.3.3 of 2.1.

3.1.1 Fill or drain water in steam drum to a level below the bottom of the manhole.

3.1.2 Inject 10 pounds of sodium nitrite for each 1,000 gallons of boiler water in a slurry solution to the water in the boiler using table 221-2-1 of 2.1 for guidance.

3.1.2.1 If boiler is pressurized, inject sodium nitrite after pressure drops to 100 PSIG or less.

3.1.3 Fill the steam drum to bring water level to the top of the gauge glass using water conforming to the following requirements:

<u>CONSTITUENT</u> or <u>PROPERTY</u>	<u>REQUIREMENT</u>
pH	5.8 to 8.0
Conductivity	2.5 micromho/cm (at point of delivery)
Dissolved Silica	0.2 ppm (0.2 mg/L) max
Hardness	0.10 epm (0.10 meg/L) max

3.1.3.1 Prevent water level from carrying the solution over into the superheater.

3.1.4 Empty boiler of water and chemicals by pumping at the hose connection in the bottom blow line. The bottom blow, superheater drain, drum vent, and economizer drain valves must be open during pumping.

3.1.4.1 Do not drain the solution to the bilge.

3.1.5 Remove each drum manhole plate and header handhole plate from boiler.

3.1.5.1 Do not remove seal welded handhole plates.

3.1.6 Blow out horizontal tubes with clean air to remove any water. Dry remaining solution from water walls, economizers, superheater headers, steam and water drums.

3.1.7 Circulate heated air with positive flow through the firesides and watersides, as long as the boiler is in a dry lay-up condition, in accordance with Paragraph 221-2.3.3.1 of 2.1. (See Note 4.1)

3.1.7.1 Introduce and exhaust heated air in accordance with Table 221-2-2 and Table 221-2-3 of 2.1.

3.2 Catapult Accumulator, Drain Accumulator: Open manway access, dry out and remove standing water in accordance with Paragraph 5.5.1 of 2.2.

3.2.1 Install temporary closures (FME) in accordance with Paragraph 5.5.3 of 2.2.

3.2.2 Provide source of heated air to the accumulator through the manway opening in accordance with Paragraph 5.4.4 of 2.2.

3.2.3 Introduce heated air through a 4.0 inch hose penetrating the temporary manhole cover in accordance with Table 221-2-3 of 2.1, Unit Type IV.

3.2.3.1 Manufacture manway cover in accordance with details 10-E through 15-E of 2.3.

3.2.4 Accomplish dehumidified air lay-up in accordance with 2.2, using 2.3 for guidance.

3.3 Reboiler Shell Side, Drain Reboiler: Accomplish dry lay-up in accordance with 2.4 and Chapter 3 of 2.5.

3.3.1 Introduce heated air through a 4.0 inch hose penetrating the temporary manhole cover in accordance with Table 221-2-3 of 2.1, Unit Type I.

3.3.2 Manufacture and install a plexiglass cover to seal the manway opening, using details 10-E through 15-E of 2.3 for guidance.

3.3.3 Install vent ducting hose (supply) and align system in accordance with Chapter 3 of 2.5.

(V) "INSPECT BOILER, ACCUMULATOR AND REBOILER LAY-UP"

3.4 Inspect the boiler, accumulator and reboiler daily and at the end of each work shift and ensure dry lay-up conditions are maintained in accordance with Paragraphs 221-2.4.6.2 and 221-2.4.6.3 of 2.1.

3.5 Remove and dispose of spent chemicals and solutions in accordance with federal, state, and local laws, codes, ordinances, and regulations.

4. NOTES:

4.1 For ships using chelant treatment, the use of sodium nitrite prior to placing boiler on hot air or desiccant lay-up is prohibited unless the ship is in a CNO Availability.

4.2 Catapult accumulator and reboiler requirements apply to CVN only.

4.3 Aluminum material may be used to manufacture manway covers when authorized by the SUPERVISOR.

NAVSEA  
STANDARD ITEM

FY-24

ITEM NO: 009-39  
DATE: 25 OCT 2022  
CATEGORY: I

1. SCOPE:

1.1 Title: Technical Manual Contract Requirement (TMCR) for a New Technical Manual for Commercial Equipment/Component; accomplish

2. REFERENCES:

2.1 NDMS-000172-000, Technical Manual Contract Requirement (TMCR); Commercial Off-The-Shelf (COTS) Equipment Requirements

2.2 NDMS-000173-000, Technical Manual Contract Requirements TMCR); Hull, Mechanical and Electrical (HM&E) Equipment Technical Manual Requirements

2.3 NDMS-000174-000, Technical Manual Contract Requirement (TMCR); Technical Manual Revision Requirements

2.4 NDMS-000175-000, Technical Manual Contract Requirement (TMCR); Technical Manual Change Package Requirements

3. REQUIREMENTS:

3.1 For a New Technical Manual for Commercial Equipment/Component, accomplish the requirements of 2.1.

3.1.1 Deliver the data items listed in Paragraph 1.3 of 2.1 as follows:

3.1.1.1 Submit 3 advance copies to the SUPERVISOR for review within 10 days upon receipt of equipment/component from the vendor.

3.1.1.2 One copy must be in a form suitable for offset printing.

3.1.2 Submit supplementary data for commercial manuals in accordance with 2.1 to the SUPERVISOR.

3.1.2.1 Deliver the data items listed in Paragraph 1.4 of 2.1 as follows:

3.1.2.2 Submit 3 review draft copies (RDC) of the supplementary data to the SUPERVISOR for review within 10 days of receipt of equipment from vendor.

3.1.2.3 One copy of the commercial manual with supplementary data inserted must be in a form suitable for offset printing.

3.2 For a Topically Structured Technical Manual accomplish the requirements of 2.2.

3.2.1 Deliver the data items listed in Paragraph 1.3 of 2.2 as follows:

3.2.1.1 Submit 3 review draft copies (RDC) to the SUPERVISOR for review within 10 days of receipt of equipment.

3.2.1.2 Submit one proof copy and one reproducible copy with integrally related art to the SUPERVISOR not later than 30 days after receipt of the reviewed final reproducible copy (FRC).

3.3 For Updating Technical Manual accomplish the requirements of 2.3 or 2.4 as appropriate.

3.3.1 Deliver the data items listed in Paragraph 1.3 of 2.3 or 2.4 as follows:

3.3.1.1 Submit 3 review draft copies (RDC) to the SUPERVISOR for review within 10 days after receipt of equipment/component.

3.3.1.2 Submit one proof copy and one final reproducible copy (FRC) with integrally related art to the SUPERVISOR not later than 30 days after receipt of the reviewed draft copy.

#### 4. NOTES:

4.1 References 2.1, 2.2, 2.3 and 2.4 are available and can be read on-line at:  
<https://nsdsa.dc3n.navy.mil>

NAVSEA  
STANDARD ITEM

FY-24

ITEM NO: 009-40  
DATE: 25 OCT 2022  
CATEGORY: I

1. SCOPE:

1.1 Title: Contractor Crane, Multi-Purpose Machine and Material Handling Equipment at a Naval Facility; provide

2. REFERENCES:

- 2.1 29 CFR Part 1910, Occupational Safety and Health Standards
- 2.2 29 CFR Part 1915, Occupational Safety and Health Standards for Shipyard Employment
- 2.3 29 CFR Part 1917, Marine Terminals
- 2.4 29 CFR Part 1926, Safety and Health Regulations for Construction
- 2.5 NAVFAC P-307, Management of Weight Handling Equipment

3. REQUIREMENTS:

3.1 Notify the SUPERVISOR one day prior to bringing any cranes, multi-purpose machines, material handling equipment, or construction equipment that may be used in a crane-like application to lift suspended loads on a Naval facility.

3.2 Comply with the requirements of 2.1 through 2.4, and Paragraph 11.1.b of 2.5, prior to bringing or using any contractor crane, multi-purpose machine and material handling equipment that may be used in a crane-like application to lift a suspended load on a Naval facility.

3.2.1 Maintain written documentation of the last weight test of the crane and all related weight handling equipment on site.

3.3 Ensure the handling and rigging gear and below the hook lifting devices and personnel comply with the following requirements:

3.3.1 Personnel performing rigging must have an understanding of all signs, notices, and operating instructions, and be familiar with the applicable hand signals prescribed by the ASME B30 standard for the type of crane in use.

3.3.2 Personnel performing rigging must be familiar with the rigging requirements in 2.1 through 2.4.

3.3.3 Provide qualified signal personnel in accordance with 2.4.



3.4 Inspect rigging gear in accordance with 2.1 through 2.4 and Paragraph 11.1.b of 2.5.

3.4.1 Maintain certification records on site available for review during all work.

3.5 Contractor must:

3.5.1 Ensure all inspections are performed in accordance with 2.1 through 2.5 (daily, monthly, quarterly, and yearly), and retain the current documentation of inspections. Documents must be kept on site.

3.5.1.1 Perform daily pre-use inspections and testing on all load hoisting and lowering mechanisms, boom hoisting and lowering mechanisms, swinging mechanisms, traveling mechanisms (if to be used that day), and safety devices.

3.5.2 Cranes that have to be re-rated must be in accordance with SAE Recommended Practice, Crane Load Stability Test Code J765 and documentation maintained on site.

3.5.3 Have an operational anti-two-block device or a two-block damage prevention feature for all points of two-blocking.

3.5.4 Have a boom hoist disconnect, shutoff, or hydraulic relief to automatically stop the boom hoist when the boom reaches a predetermined high angle.

3.6 Conduct a joint verification with the Government representative to ensure that a legible and indelible completed copy of Appendix P, Figure P-1 of 2.5 is maintained on the crane, multi-purpose and material handling equipment used in a crane-like application to lift suspended loads. The following certification and testing documentation must be on site prior to entry and use on any Naval facility:

3.6.1 Crane, multi-purpose and material handling equipment used in a crane-like application to lift suspended loads certification

3.6.2 Load testing

3.6.3 Yearly, monthly, and daily inspection logs

3.6.4 Rope/sling certifications

3.6.5 Operator certifications/designations

3.6.6 Designation of person performing log inspections

3.6.7 Cranes that are permanently located on a Naval facility must have a quarterly joint verification.

3.7 Develop and maintain on site a critical lift plan in accordance with Attachment A.

3.7.1 Complete and maintain a copy of Attachment B for each critical lift.

3.7.2 Notify SUPERVISOR of each critical lift no later than five days prior to the planned event.

3.7.3 Submit one legible copy, in hard copy or approved transferrable media, of Attachment A to the SUPERVISOR, upon request.

3.8 Report verbally each accident to the SUPERVISOR immediately but not later than 4 hours of such an event.

3.8.1 Secure the accident site and preserve the scene until released by the SUPERVISOR.

3.8.1.1 Conduct an accident investigation to establish root cause(s) of any accident.

3.8.2 Withhold further crane, multi-purpose and material handling equipment operations until the cause is determined and corrective actions are implemented and approved by the SUPERVISOR.

3.8.3 A crane and rigging gear accident is when any of the following occurs during crane, multi-purpose and material handling equipment operations:

3.8.3.1 Personnel injury or death

3.8.3.2 Material or equipment damage

3.8.3.3 Dropped load

3.8.3.4 Derailment

3.8.3.5 Two-blocking

3.8.3.6 Overload

3.8.3.7 Collision, including unplanned contact between the load, crane, multi-purpose, material handling equipment and/or other objects

3.8.4 Provide a formal written report of the event to the SUPERVISOR within one day of each accident.

3.8.5 Submit one legible copy, in approved transferrable media, of the accident report consisting of a summary of circumstances, and explanation of cause(s), and corrective actions taken, using Attachment C, to the SUPERVISOR within 15 days of each accident.

#### 4. NOTES:

4.1 None.

ATTACHMENT A

Critical Lift Form

Location:
Date of critical lift:
Crane operator:
Crane/Rigging Supervisor:
Contractors:
Ship's Force representative:
Work Item number:

Type of Critical Lift:
------------------------

Load Description:
Weight of load being lifted:
Size of load being lifted:

Weight of Headache Ball:
Weight of Block:
Weight of Lifting Bar:
Weight of Slings & Shackles:
Total of other deductions:
Total weight of load plus deductions:

OEM's maximum load capacities for the entire range of the lift:
---

Lift Geometry

Crane position:
Boom length:
Boom angle:
Height of lift:
Radius for the entire range of the lift:

Barge Mounted Mobile Cranes

Barge stability calculations identifying crane placement/footprint:
Barge list and trim based on anticipated loading:
Load charts based on calculated list and trim specific to the barge the crane is mounted on:

Environmental Conditions

Environmental conditions under which lift operations are to be stopped:
---

Rigging Plan

Lift points:
Rigging gear:
Rigging procedure:

Use space below to describe rigging plan:

Attachment "A" Instructions

- Location: Location where critical lift will be conducted, e.g. pier and vessel.
- Date of critical lift: When critical lift will be conducted. A critical lift plan is required for each day.
- Crane operator: Name of crane operator during critical lift.
- Crane/Rigging Supervisor: Person supervising crane/rigging operations during critical lift.
- Contractors: List all contractors involved with critical lift e.g. AITs, subcontractors and divers.
- Ship's Force representative: S/F representative notified of critical lift e.g. CDO.
- Work Item number: Navy work item number for which critical lift is being conducted.
- Type of Critical Lift: See NAVFAC P-307, Management of Weight Handling Equipment.
- Load Description: Self explanatory.
- Weight of load being lifted: Self explanatory.
- Size of load being lifted: Self explanatory.
- Weight of Headache Ball: Self explanatory.
- Weight of Block: Self explanatory.
- Weight of Lifting Bar: Self explanatory.
- Weight of Slings & Shackles: Self explanatory.
- Total of other deductions: Self explanatory. List other deductions.
- Total weight of load plus deductions: Self explanatory.
- OEM's maximum load capacities for the entire range of the lift: Review load chart.
- Crane position: Self explanatory.
- Boom length: Self explanatory.
- Boom angle: Self explanatory.
- Height of lift: Self explanatory.
- Radius for the entire range of the lift: Self explanatory.
- Lift points: Where on the load will the load be lifted from.
- Rigging gear: What rigging gear will be used during critical lift.
- Rigging procedure: How will the load be rigged and path the load will travel to destination.

ATTACHMENT B

CONTRACTOR CRANE OPERATION CHECKLIST FOR CRITICAL LIFTS		YES	NO
1	Does the operator know the weight of the load to be lifted?		
2	Is the load to be lifted within the crane manufacturer's rated capacity in its present configuration?		
3	Is the crane level and on firm ground?		
4	Are outriggers required?		
5	If so, are outriggers fully extended and down, and the crane load off the wheels?		
6	If blocking is required, is the entire surface of the outrigger pad supported and is the blocking material of sufficient strength to safely support the loaded outrigger pad?		
7	If outriggers are not used, is the crane rated for on-rubber lifts by the manufacturer's load chart?		
8	Is the swing radius of the crane counterweight clear of people and obstructions and accessible areas within the swing area barricaded to prevent injury or damage?		
9	Has the hook been centered over the load in such a manner to minimize swing?		
10	Is the load well secured and balanced in the sling or lifting device before it is lifted more than a few inches?		
11	Is the lift and swing path clear of obstructions?		
12	If rotation of the load being lifted is hazardous, is a tag or restraint line being used?		
13	Are personnel prevented from standing or passing under a suspended load?		
14	Is the crane operator's attention diverted?		
15	Are proper signals being used at all times?		
16	Do the operations ensure that side loading is prohibited?		
17	Are personnel prevented from riding on a load?		
18	Are start and stop motions in a smooth fluid motion (no sudden acceleration or deceleration)?		
19	If operating near electric power lines, are the rules and guidelines understood and adhered to?		
20	Is the lift a critical lift?		
21	If so, are critical lift regulations understood, check-off sheets initialed and signed off, and was there an interactive brief conducted with associated personnel?		
22	Is Appendix P, Figure P-1 of 2.6 current, filled out completely, and posted in the crane?		
Contractor:		Subcontractor:	
Location:		Date:	

Attachment C  
FOR OFFICIAL USE ONLY

**CRANE AND RIGGING GEAR ACCIDENT REPORT**

Accident Category: <input type="checkbox"/> Crane Accident <input type="checkbox"/> Rigging Gear Accident			
From:		To: SUPERVISOR	
Activity:			Report No:
Crane No:	Category:	Accident Date:	Time: hrs
Category of Service: <input type="checkbox"/> SPS <input type="checkbox"/> GPS	Crane Type:	Crane Manufacturer:	
Was Crane/Rigging Gear Being Used in SPS? Yes _____ No _____		Was Crane/Rigging Gear Being Used in a Complex Lift/Critical non-crane rigging operation? Yes _____ No _____	
Location:		Weather:	
Crane Capacity:	Hook Capacity:	Weight of Load on Hook:	
Fatality or Permanent Disability? <input type="checkbox"/> Yes <input type="checkbox"/> No		Material/Property Cost Estimate:	
<p>Accident Type:</p> <p><input type="checkbox"/> Personal Injury      <input type="checkbox"/> Over load      <input type="checkbox"/> Derail      <input type="checkbox"/> Damaged Rigging Gear</p> <p><input type="checkbox"/> Load Collision      <input type="checkbox"/> Two Blocked      <input type="checkbox"/> Dropped Load      <input type="checkbox"/> Damaged Crane</p> <p><input type="checkbox"/> Crane Collision      <input type="checkbox"/> Damaged Load      <input type="checkbox"/> Other Specify _____</p>			
<p>Cause of Accident:</p> <p><input type="checkbox"/> Improper Operation      <input type="checkbox"/> Equipment Failure      <input type="checkbox"/> Inadequate Visibility</p> <p><input type="checkbox"/> Improper Rigging      <input type="checkbox"/> Switch Alignment      <input type="checkbox"/> Inadequate Communication</p> <p><input type="checkbox"/> Track Condition      <input type="checkbox"/> Procedural Failure      <input type="checkbox"/> Other Specify _____</p>			

Chargeable to: <input type="checkbox"/> Crane Walker <input type="checkbox"/> Rigger <input type="checkbox"/> Operator <input type="checkbox"/> Maintenance <input type="checkbox"/> Management/Supervision <input type="checkbox"/> Other Specify _____			
Crane Function: <input type="checkbox"/> Travel <input type="checkbox"/> Hoist <input type="checkbox"/> Rotate <input type="checkbox"/> Luffing <input type="checkbox"/> Telescoping <input type="checkbox"/> Other <input type="checkbox"/> N/A			
Is this accident indicative of a recurring problem? <input type="checkbox"/> Yes <input type="checkbox"/> No  If yes, list Accident Report Nos.: _____			
<b>ATTACH COMPLETE AND CONCISE SITUATION DESCRIPTION AND CORRECTIVE/PREVENTIVE ACTIONS TAKEN AS ENCLOSURE (1). Include probable cause and contributing factors. Assess damages and define responsibility. For equipment malfunction or failure, include specific description of the component and the resulting effect or problem caused by the malfunction or failure. List immediate and long term corrective/preventive actions assigned and respective codes.</b>			
Preparer:	Phone and email	Code	Date
Concurrences:			
	Code	Date	
	Code	Date	
Certifying Official (Crane Accidents Only):	Code	Date	

FOR OFFICIAL USE ONLY



## Attachment "C" Instructions

### CRANE AND RIGGING GEAR ACCIDENT REPORT INSTRUCTIONS

Electronic submission will be accepted without signatures but the names of the preparer, concurring personnel, and certifying official (for crane accidents only) must be filled in.

1. Accident Category: Indicate either crane accident or rigging gear accident.
2. From: The contractor that is responsible for reporting the accident.
3. Activity: The naval activity where the accident took place.
4. Report No.: The activity assigned accident number (e.g., 95-001).
5. Crane No.: The activity assigned crane number (e.g., PC-5), if applicable.
6. Category: Identify category of crane (i.e., 1, 2, 3, or 4), if applicable.
7. Accident Date: The date the accident occurred.
8. Time: The time (24 hour clock) the accident occurred (e.g., 1300).
9. Category of Service: Check the applicable service (SPS as defined by NAVSEA 0989-030-7000).
10. Crane Type: The type of crane involved in the accident (e.g., mobile, bridge), if applicable.
11. Crane Manufacturer: The manufacturer of the crane (e.g., Dravo, Grove, P&H), if applicable.
12. SPS: Was the crane or rigging gear being used in an SPS lift?
13. Complex lift: Was the crane or rigging gear being used in a complex lift?
14. Location: The detailed location where the accident took place (e.g., building 213, dry dock 5).
15. Weather: The weather conditions at time of accident (e.g., wind, rain, cold).
16. Crane Capacity: The certified capacity of the crane (e.g., 120,000 pounds), if applicable.
17. Hook Capacity: The capacity of the hook involved in the accident at the maximum radius of the operation, if applicable.
18. Weight of Load on Hook: If applicable, the weight of the load on the hook.
19. Fatality or Permanent Disability?: Check yes or no.
20. Material/Property Cost Estimate: Estimate total cost of damage resulting from the accident.
21. Reported to NAVSAFECEN?: Self-explanatory.

Attachment "C" Instructions

22. Accident Type: Check all that apply.
23. Cause of Accident: Check all that apply.
24. Chargeable to: Check all that apply.
25. Crane Function: Check the function(s) in operation at time of accident. Check all that apply. Check N/A if a rigging gear accident.
26. Is this a recurring problem?: Check yes or no. Identify any other similar accidents.
27. Situation Description/Corrective Actions: Self-explanatory.
28. Preparer: Self-explanatory.
29. Concurrences: Self-explanatory.
30. Certifying Official (Crane Accidents Only): Self-explanatory.

NAVSEA  
STANDARD ITEM

FY-24

ITEM NO: 009-45  
DATE: 25 OCT 2022  
CATEGORY: II

1. SCOPE:

1.1 Title: Tapered Plug Valve; repair

2. REFERENCES:

2.1 S9086-RJ-STM-010/CH-504, Pressure, Temperature and Other Mechanical and Electromechanical Measuring Instruments

3. REQUIREMENTS:

3.1 Matchmark each valve part.

3.2 Disassemble, clean each internal and external surface free of foreign matter (including paint), and inspect each part for defects.

3.3 Repair valve as follows:

3.3.1 Machine, grind, or lap and spot-in plug to bore to obtain an 80 percent minimum surface contact, evenly distributed over 100 percent of the area.

(V) "INSPECT CONTACT"

3.3.1.1 Inspect contact using blueing method.

3.3.1.2 Vertical misalignment of ports in the plug valve and body with the plug fully seated must not be of a degree that will restrict flow.

3.3.2 Chase and tap exposed threaded areas.

3.3.3 Dress and true gasket mating surfaces.

3.4 Assemble each valve installing new each packing, each gasket and each fastener for those removed in 3.2 in accordance with manufacturer's specification or instruction.

3.4.1 Lubricate each MIL-PRF-24509 valve with grease conforming to SAE-AMSG-6032.

3.5 Hydrostatically test valve as follows:

3.5.1 Hydrostatic test equipment must have the following capabilities:

3.5.1.1 Manual overpressure protection release valve.

3.5.1.2 Self-actuated and resetting relief valve with a set point no greater than 100 PSIG above the test pressure or 10 percent above the test pressure, whichever is less.

3.5.1.3 Master and backup test gauges with gauge range and graduation shown on Table 504-6-1 of 2.1. The backup gauge must be cross-checked to the master hydrostatic test gauge up to the maximum test pressure just prior to start of testing. Master and backup gauges must track within 2 percent of each other.

3.5.1.4 Protection equipment must be accessible and test gauges must be located where clearly visible and readable to pump operator and inspector.

(I) "SEAT TIGHTNESS"

3.5.2 Test for seat tightness with valve in closed position with opposite side open for inspection.

3.5.2.1 Plug must be seated by hand force.

3.5.2.2 Test must be continued for a minimum of 3 minutes if there is no evidence of leakage or, in the event of visible leakage, until accurate determination of leakage can be made.

3.5.2.3 Maximum allowable leakage for a metal-to-metal seated valve: 10 cubic centimeters (cc) per hour, per inch of nominal pipe size; 10 cc maximum per hour for valve sizes less than 1-1/2 inches.

3.5.2.4 Allowable leakage for soft seated plug: None.

(I) "SEAT TIGHTNESS"

3.5.3 Test plug valve of duplex strainer to each strainer chamber with unpressurized side top cover removed (2 tests per strainer). Allowable leakage: With the drain valve closed the non-pressurized side must not fill within one hour.

4. NOTES:

4.1 Test pressures of 3.5.2 and 3.5.3 will be specified in Work Item.

4.2 Repair of valve operating gear will be specified in Work Item.

4.3 Test medium will be specified in Work Item.

NAVSEA  
STANDARD ITEM

FY-24

ITEM NO: 009-46  
DATE: 25 OCT 2022  
CATEGORY: II

1. SCOPE:

1.1 Title: Butterfly Valve, Synthetic and Metal Seated; repair

2. REFERENCES:

2.1 S9086-RJ-STM-010/CH-504, Pressure, Temperature and Other Mechanical and Electromechanical Measuring Instruments

3. REQUIREMENTS:

3.1 Matchmark each valve part.

3.2 Disassemble, clean each internal and external surface free of foreign matter (including paint), and inspect each part for defects.

3.3 Repair valve as follows:

3.3.1 Polish stem to remove raised edges and foreign matter.

3.3.2 Chase and tap exposed threaded areas.

3.3.3 Machine, grind, or lap and spot-in metal-to-metal seat to disc to obtain a leakage rate at or below that allowed in 3.5.5.

3.3.4 Polish seating surface of synthetic seated valve to remove high spots, nicks, and burrs.

3.4 Assemble valve installing new each bushing, each O-Ring, each V-Ring, each valve liner, each seat assembly, each washer, each pin, and each fastener for those removed in 3.2 in accordance with manufacturer's specifications or instructions.

3.5 Hydrostatically test valve as follows:

3.5.1 Hydrostatic test equipment must have the following capabilities:

3.5.1.1 Manual overpressure protection release valve.

3.5.1.2 Self-actuated and resetting relief valve with a set point no greater than 100 PSIG above the test pressure or 10 percent above the test pressure, whichever is less.

3.5.1.3 Master and backup test gauges with gauge range and graduation in accordance with Table 504-6-1 of 2.1. The backup gauge must be cross-checked to the master hydrostatic test gauge up to the maximum test pressure just prior to start of testing. Master and backup gauges must track within 2 percent of each other.

3.5.1.4 Protection equipment must be accessible and test gauges must be located where clearly visible and readable to pump operator and inspector.

(I) "SEAT TIGHTNESS"

3.5.2 Test for seat tightness alternately on each side of the disc with opposite side open for inspection.

3.5.3 Disc must be seated by hand force.

3.5.4 Test must be continued for a minimum of 3 minutes if there is no evidence of leakage, or in the event of visible leakage, until accurate determination of leakage can be made.

3.5.5 Leakage rate of metal-to-metal seated valves:

3.5.5.1 Valves conforming to MIL-DTL-24624, Type II must not exceed the following criteria:

<u>Valve size</u> <u>inches</u>	<u>Leakage rate</u> <u>gal/min</u>	<u>Valve size</u> <u>inches</u>	<u>Leakage rate</u> <u>gal/min</u>
2	1.5	10	35
2-1/2	2.25	12	50
3	3.25	14	60
4	6	16	80
5	9.5	18	100
6	14	20	140
8	25	24	200

3.5.5.2 Valves conforming to MIL-DTL-24624 must have a maximum seat leakage rate of 10 cubic centimeters per inch of nominal pipe size per hour.

3.5.6 Allowable leakage for synthetic seated valve: None.

4. NOTES:

4.1 The test pressure of 3.5.2 will be specified in Work Item.

4.2 Repair of valve operating gear will be specified in Work Item.

4.3 Test medium will be specified in Work Item.

NAVSEA  
STANDARD ITEM

FY-24

ITEM NO: 009-47  
DATE: 25 OCT 2022  
CATEGORY: II

1. SCOPE:

1.1 Title: Gate Valve; repair

2. REFERENCES:

2.1 S9086-CJ-STM-010/CH-075, Fasteners

2.2 S9253-AD-MMM-010, Maintenance Manual for Valves, Traps, and Orifices (Non-Nuclear), User's Guide and General Information

2.3 S9086-RJ-STM-010/CH-504, Pressure, Temperature and Other Mechanical and Electromechanical Measuring Instruments

2.4 S9086-RK-STM-010/CH-505, Piping Systems

3. REQUIREMENTS:

3.1 Matchmark each valve part.

3.2 Disassemble, clean internal and external surfaces free of foreign matter (including paint), and inspect each part for defects.

3.2.1 The removal of body-bound studs only to determine the condition of threads is not required.

(I) or (V) "TORQUE TEST" (See 4.3)

3.2.2 Torque test each body-bound stud in accordance with Section 075-8.6.3.2(d) of 2.1.

3.3 Repair valve as follows:

3.3.1 Straighten stem to within 0.002-inch total indicator reading. Polish stem to a 32 Root-Mean-Square finish in way of packing surface and remove raised edges and foreign matter.

3.3.2 Chase and tap each exposed threaded area.

3.3.3 Dress and true each gasket mating surface.

3.3.4 Machine, grind, or lap and spot-in gate to seats (including backseat) to obtain a 360-degree continuous contact.

3.3.4.1 Inspect contact using blueing method.

3.3.4.2 Transfer line must not exceed 3/16-inch in width and must appear within the lower 75 percent of the gate seating surface.

(I)(G) "VERIFY LEVEL I PARTS AND CLEANLINESS"

3.4 Assemble each valve installing new each packing, each gasket and each fastener for those removed in 3.2 in accordance with the manufacturer's specifications.

3.4.1 Pack feedwater, condensate, and steam valves with valve stem packing conforming to MIL-P-24503/MIL-DTL-24583 combination in accordance with Chapter 6 of 2.2.

3.4.2 Pack valves of systems other than feedwater, condensate, or steam with valve stem packing conforming to MIL-P-24396, Type B.

3.5 Hydrostatically test valve as follows:

3.5.1 Hydrostatic test equipment must have the following capabilities:

3.5.1.1 Manual overpressure protection release valve.

3.5.1.2 Self-actuated and resetting relief valve with a set point no greater than 100 PSIG above the test pressure or 10 percent above the test pressure, whichever is less.

3.5.1.3 Master and backup test gauges with gauge range and graduation in accordance with Table 504-6-1 of 2.3. The backup gauge must be cross-checked to the master hydrostatic test gauge up to the maximum test pressure just prior to start of testing. Master and backup gauges must track within 2 percent of each other.

3.5.1.4 Protection equipment must be accessible and test gauges must be located where clearly visible and readable to pump operator and inspector.

(V)(G) or (I)(G) "SEAT TIGHTNESS" (See 4.4)

3.5.2 Test for seat tightness alternately on each side of gate for double seated valves, and on outboard side only on single-seated valves, with the opposite side open for inspection.



3.5.2.1 Do not exceed the handwheel closing force specified in Table 505-11-2 of 2.4.

3.5.2.2 Test must be continued for a minimum of 3 minutes if there is no evidence of leakage, or in the event of visible leakage, until accurate determination of leakage can be made. Maximum allowable leakage: 10 cubic centimeters (cc) per hour, per inch of nominal pipe size; 10 cc maximum per hour for valve sizes less than 1-1/2 inches.

4. NOTES:

4.1 The test pressures of 3.5.2 will be specified in Work Item.

4.2 Repair of valve operating gear will be specified in Work Item.

4.3 The paragraph referencing this note is considered an (I) if the valve is Level I. If the valve is not Level I, the paragraph is considered a (V).

4.4 The paragraph referencing this note is considered an (I)(G) if the valve is Level I. If the valve is not Level I, the paragraph is considered a (V)(G).

4.5 Test medium will be specified in Work Item.

NAVSEA  
STANDARD ITEM

FY-24

ITEM NO: 009-48  
DATE: 25 OCT 2022  
CATEGORY: II

1. SCOPE:

1.1 Title: Pressure Seal Bonnet Valve Shop Repair; accomplish

2. REFERENCES:

2.1 S9086-CJ-STM-010/CH-075, Fasteners

2.2 T9074-AS-GIB-010/271, Requirements for Nondestructive Testing Methods

2.3 MIL-STD-2035, Nondestructive Testing Acceptance Criteria

2.4 803-6074287, Repair Guide, Pressure Seal Valves

2.5 803-5001021, Pressure Seal Rings Standard and Oversize Valve Pressure Class 600-1500

2.6 S9253-AD-MMM-010, Maintenance Manual for Valves, Traps, and Orifices (Non-Nuclear), User's Guide and General Information

2.7 S9086-RJ-STM-010/CH-504, Pressure, Temperature and Other Mechanical and Electromechanical Measuring Instruments

2.8 S9086-RK-STM-010/CH-505, Piping Systems

3. REQUIREMENTS:

3.1 Matchmark each valve part.

3.2 Disassemble, clean each internal and external surface free of foreign matter (including paint), and inspect each part for defects.

3.2.1 The removal of body-bound studs only to determine the condition of threads is not required.

(I) or (V) "TORQUE TEST" (See 4.3)

3.2.2 Torque test each body-bound stud in accordance with Section 075-8.6.3.2(d) of 2.1.

(I) "LIQUID PENETRANT INSPECT"

3.2.3 Accomplish liquid penetrant inspection of seats (including back seat), discs, or gate and body inlay area in accordance with 2.2.

3.2.3.1 Acceptance criteria must be in accordance with Paragraph 7 of 2.3, except hairline cracks in hard-faced areas of seats and discs or gate are acceptable provided the valve does not show evidence of leakage.

3.3 Repair valve as follows:

3.3.1 Straighten stem to within 0.002-inch total indicator reading. Polish stem to a 32 Root-Mean-Square (RMS) finish in way of packing surface and remove raised edges and foreign matter.

3.3.2 Chase and tap each exposed threaded area.

3.3.3 Dress and true each gasket mating surface.

3.3.4 Inspect and repair sealing surfaces of each inlay area and bonnet as follows:

(I) or (V) "VISUAL INSPECT" (See 4.3)

3.3.4.1 Inspect valve body to verify that stainless steel inlay is free of steam cuts and cracks and diameter of inlay area is round to within 0.003 inch and free of non-design taper. Measure diameter at top and bottom of inlay area in increments of 45 degrees, on each circle.

3.3.4.2 For the inlay, correct out-of-round, non-design tapered condition and provide 32 RMS finish. Finished inlay diameter must provide 0.002 to 0.005 inch clearance on the standard size diameter for seal rings described by 2.4.

3.3.4.3 Machine valve bonnet tapered area for concentricity and design angle to within 0.002 inch total indicator reading and 32 RMS finish.

3.3.5 Machine, grind, or lap and spot-in discs or gate to seats (including back seat) to obtain a 360-degree continuous contact.

(I) or (V) "INSPECT CONTACT" (See 4.3)

3.3.5.1 Inspect contact using blueing method.

3.3.5.2 Transfer line for gate valve must not exceed 3/16 inch in width and must appear within the lower 75 percent of the gate seating surface.

3.3.5.3 Transfer line for globe valve must not exceed 1/16 inch in width.

(I)(G) "VERIFY LEVEL I PARTS AND CLEANLINESS"

3.4 Assemble each valve installing new each fastener for those removed in 3.2 in accordance with manufacturer's specification or instruction.

3.4.1 Install new seal ring in accordance with 2.4, using 2.5 for guidance.

3.4.1.1 The SUPERVISOR must approve fitting new seal ring to inlay bores above first oversize.

3.4.1.2 Attach a metal identification tag to the valve bonnet indicating the size of seal ring installed, straight or tapered body neck, name of installing activity, and date of installation.

3.4.2 Install new valve stem packing conforming to MIL-P-24503/ MIL-DTL-24583 combination in accordance with Chapter 6 of 2.6.

3.5 Hydrostatically test valve as follows:

3.5.1 Hydrostatic test equipment must have the following capabilities:

3.5.1.1 Manual overpressure protection release valve.

3.5.1.2 Self-actuated and resetting relief valve with a set point no greater than 100 PSIG above the test pressure or 10 percent above the test pressure, whichever is less.

3.5.1.3 Master and backup test gauges with gauge range and graduation in accordance with Table 504-6-1 of 2.7. The backup gauge must be cross-checked to the master hydrostatic test gauge up to the maximum test pressure just prior to start of testing. Master and backup gauges must track within 2 percent of each other.

3.5.1.4 Protection equipment must be accessible and test gauges must be located where clearly visible and readable to pump operator and inspector.

(V)(G) or (I)(G) "SEAT TIGHTNESS" (See 4.4)

3.5.2 Test for seat tightness alternately on each side of gate for double seated valves, and on outboard side only on single seated valves, with the opposite side open for inspection.

3.5.2.1 Do not exceed handwheel closing force specified in Table 505-11-2 of 2.8.

3.5.2.2 Test must be continued for a minimum of 3 minutes if there is no evidence of leakage, or in the event of visible leakage, until accurate determination of leakage can be made. Maximum allowable leakage: 10 cubic centimeters (cc) per hour, per inch of nominal pipe size; 10 cc maximum per hour for valve sizes less than 1-1/2 inches.

(V)(G) or (I)(G) “SEAT TIGHTNESS” (See 4.4)

3.5.3 Test globe valve in the direction tending to open valve.

3.5.3.1 Do not exceed the handwheel closing force specified in Table 505-11-2 of 2.8.

3.5.3.2 Test must be continued for a minimum of 3 minutes if there is no evidence of leakage, or in the event of visible leakage, until accurate determination of leakage can be made. Maximum allowable leakage: 10 cubic centimeters (cc) per hour, per inch of nominal pipe size; 10 cc maximum per hour for valve sizes less than 1-1/2 inches.

#### 4. NOTES:

4.1 The test pressures of 3.5.2 and 3.5.3 will be specified in Work Item.

4.2 Repair of valve operating gear will be specified in Work Item.

4.3 The paragraph referencing this note is considered an (I) if the valve is Level I. If the valve is not Level I, the paragraph is considered a (V).

4.4 The paragraph referencing this note is considered an (I)(G) if the valve is Level I. If the valve is not Level I, the paragraph is considered a (V)(G).

4.5 Reference 2.5 provides guidance with respect to applicable APLs and other information not in direct conflict with the material and hardness requirements for seal rings specified in 2.4.

4.6 Test medium will be specified in Work Item.

NAVSEA  
STANDARD ITEM

FY-24

ITEM NO: 009-49  
DATE: 25 OCT 2022  
CATEGORY: II

1. SCOPE:

1.1 Title: Pressure Seal Bonnet Valve In-line Repair; accomplish

2. REFERENCES:

2.1 S9086-CJ-STM-010/CH-075, Fasteners

2.2 T9074-AS-GIB-010/271, Requirements for Nondestructive Testing Methods

2.3 MIL-STD-2035, Nondestructive Testing Acceptance Criteria

2.4 803-6074287, Repair Guide, Pressure Seal Valves

2.5 803-5001021, Pressure Seal Rings Standard and Oversize Valve Pressure Class 600-1500

2.6 S9253-AD-MMM-010, Maintenance Manual for Valves, Traps, and Orifices (Non-Nuclear), User's Guide and General Information

3. REQUIREMENTS:

3.1 Matchmark each valve part.

3.2 Disassemble, clean free of foreign matter (including paint), and inspect each part for defects.

3.2.1 The removal of body-bound studs only to determine the condition of threads is not required.

(I) or (V) "TORQUE TEST" (See 4.3)

3.2.2 Torque test each body-bound stud in accordance with Section 075-8.6.3.2(d) of 2.1.

(I) "LIQUID PENETRANT INSPECT"

3.2.3 Accomplish liquid penetrant inspection of seats (including back seat), discs or gate, and body inlay area in accordance with 2.2.

3.2.3.1 Acceptance criteria must be in accordance with Paragraph 7 of 2.3, except hairline cracks in hard-faced seats and discs or gate are acceptable provided the valve does not show evidence of leakage.

3.3 Repair valve as follows:

3.3.1 Straighten stem to within 0.002-inch total indicator reading. Polish stem to a 32 Root-Mean-Square (RMS) finish in way of packing surface and remove raised edges and foreign matter.

3.3.2 Chase and tap each exposed threaded area.

3.3.3 Inspect and repair sealing surfaces of each inlay area and bonnet as follows:

(I) or (V) "VISUAL INSPECT" (See 4.3)

3.3.3.1 Inspect valve body to verify that stainless steel inlay is free of steam cuts and cracks and that diameter of inlay area is round to within 0.003 inch and free of non-design taper. Measure diameter at top and bottom of inlay area in increments of 45 degrees, on each circle.

3.3.3.2 For the inlay, correct out-of-round, non-design tapered condition and provide 32 RMS finish. Finished inlay diameter must not exceed oversize number one diameter, plus 0.002 to 0.005-inch clearance described by 2.4.

3.3.3.3 Machine valve bonnet tapered area for concentricity and design angle to within 0.002-inch total indicator reading and 32 RMS finish.

3.3.4 Machine, grind, or lap and spot-in discs or gate to seats (including back seat) to obtain a 360-degree continuous contact.

(I) or (V) "INSPECT CONTACT" (See 4.3)

3.3.4.1 Inspect contact using blueing method.

3.3.4.2 Transfer line for gate valve must not exceed 3/16-inch in width and must appear within the lower 75 percent of the gate seating surface.

3.3.4.3 Transfer line for globe valve must not exceed 1/16-inch in width.

(I)(G) "VERIFY LEVEL I PARTS AND CLEANLINESS"

3.4 Assemble each valve, installing new each fastener for those removed in 3.2 in accordance with manufacturer's specification or instruction.

3.4.1 Install new seal ring in accordance with 2.4, using 2.5 for guidance.

3.4.1.1 The SUPERVISOR must approve new seal rings to inlay bores above first oversize.

3.4.1.2 Attach a metal identification tag to the valve bonnet indicating the size of seal ring installed, straight or tapered body neck, name of installing activity, and date of installation.

3.4.2 Install new valve stem packing conforming to MIL-P-24503/ MIL-DTL-24583 combination in accordance with Chapter 6 of 2.6.

4. NOTES:

4.1 Operational test of the valve will be specified in Work Item.

4.2 Repair of valve operating gear will be specified in Work Item.

4.3 The paragraph referencing this note is considered an (I) if the valve is Level I. If the valve is not Level I, the paragraph is considered a (V).



NAVSEA  
STANDARD ITEM

FY-24

ITEM NO: 009-50  
DATE: 25 OCT 2022  
CATEGORY: II

1. SCOPE:

1.1 Title: Horizontal Swing Check Valve; repair

2. REFERENCES:

2.1 S9086-RJ-STM-010/CH-504, Pressure, Temperature and Other Mechanical and Electromechanical Measuring Instruments

3. REQUIREMENTS:

3.1 Matchmark each valve part.

3.2 Disassemble, clean each internal and external surface free of foreign matter (including paint), and inspect each part for defects.

3.3 Repair valve as follows:

3.3.1 Chase and tap each exposed threaded area.

3.3.2 Dress and true each gasket mating surface.

3.3.3 Machine, grind, or lap and spot-in disc to seat to obtain 360-degree continuous contact.

(V) "INSPECT CONTACT"

3.3.3.1 Inspect contact using blueing method.

3.3.3.2 Transfer line for swing check valve must not exceed 1/16-inch in width.

3.4 Assemble each valve installing new each gasket, each bushing, each disc retaining nut, each hinge pin, and each plug for those removed in 3.2 in accordance with manufacturer's specifications or instruction.

3.5 Hydrostatically test valve as follows:

3.5.1 Hydrostatic test equipment must have the following capabilities:

3.5.1.1 Manual overpressure protection release valve.

3.5.1.2 Self-actuated and resetting relief valve with a set point no greater than 100 PSIG above the test pressure or 10 percent above the test pressure, whichever is less.

3.5.1.3 Master and backup test gauges with gauge range and graduation in accordance with Table 504-6-1 of 2.1. The backup gauge must be cross-checked to the master hydrostatic test gauge up to the maximum test pressure just prior to start of testing. Master and backup gauges must track within 2 percent of each other.

3.5.1.4 Protection equipment must be accessible and test gauges must be located where clearly visible and readable to pump operator and inspector.

(I) "SEAT TIGHTNESS"

3.5.2 Test for seat tightness in the direction tending to close the valve (back pressure) for a minimum of 5 minutes. Allowable leakage as follows:

<u>VALVE SIZE (NOM)</u>	<u>LEAKAGE RATE</u>
Up to 2 inches inclusive	25 cc/hr./in. dia.
2-1/2 inches - 10 inches inclusive	50 cc/hr./in. dia.
Over 10 inches	100 cc/hr./in. dia.

The back pressure applied must be in accordance with the following:

<u>VALVE PRESSURE RATING</u>	<u>TEST BACK PRESSURE</u>
150 PSIG and Below	50 PSIG
Over 150 PSIG	100 PSIG

4. NOTES:

4.1 Test medium will be specified in Work Item.

NAVSEA  
STANDARD ITEM

FY-24

ITEM NO: 009-52  
DATE: 25 OCT 2022  
CATEGORY: II

1. SCOPE:

1.1 Title: Relief Valve; repair

2. REFERENCES:

2.1 S9086-RJ-STM-010/CH-504, Pressure, Temperature and Other Mechanical and Electromechanical Measuring Instruments

3. REQUIREMENTS:

3.1 Matchmark each valve part.

3.2 Disassemble, clean each internal and external surface free of foreign matter (including paint), and inspect each parts for defect.

3.3 Repair valve as follows:

3.3.1 Straighten stem to within 0.002-inch total indicator reading. Polish stem to a 32 Root-Mean-Square finish and remove raised edges and foreign matter.

3.3.2 Machine, grind, or lap and spot-in metallic disc to seat to obtain a 360-degree continuous contact.

3.3.2.1 Inspect contact using blueing method. Transfer line must not exceed 1/16-inch in width.

3.3.3 Dress and true each gasket mating surface.

3.3.4 Chase and tap each exposed threaded area.

3.4 Assemble valve installing new each packing, each soft seat, each gasket, and each fastener for those removed in 3.2 in accordance with manufacturer's specifications or instruction.

3.5 Hydrostatically test valve as follows:

3.5.1 Hydrostatic test equipment must have the following capabilities:

3.5.1.1 Manual overpressure protection release valve.

3.5.1.2 Self-actuated and resetting relief valve with a set point no greater than 100 PSIG above the test pressure or 10 percent above the test pressure, whichever is less.

3.5.1.3 Master and backup test gauges with gauge range and graduation in accordance with Table 504-6-1 of 2.1. The backup gauge must be cross-checked to the master hydrostatic test gauge up to the maximum test pressure just prior to start of testing. Master and backup gauges must track within 2 percent of each other.

3.5.1.4 Protection equipment must be accessible and test gauges must be located where clearly visible and readable to pump operator and inspector.

(I) "SHOP TEST"

3.5.2 Set valve to lifting pressure. (See Note 4.1 through 4.3)

3.5.3 Seat tightness test must be accomplished for a minimum of 3 minutes.  
Allowable leakage: None.

3.5.4 Purge valve of test medium.

3.5.5 Install wire and lead lock seals.

3.6 Attach a metal tag to valve, stamped with the following information:

3.6.1 Ship name and hull number

3.6.2 Valve number or identification

3.6.3 Valve lifting pressure

3.6.4 Date valve tested and set

3.6.5 Name of repair facility

4. NOTES:

4.1 Test medium, seat tightness, and lifting pressures will be specified in Work Item.

4.2 Steam relief valves must have setpoint established using steam as the test medium.

4.3 Steam system service and heating boiler pressure relief valves constructed to MIL-DTL-20065, ASME BPVC Section VIII or ASTM F1508 must have setpoint established using steam, nitrogen/dry, oil-free air or a combination of water and nitrogen/dry, oil-free air as the test medium, as specified in the work item.

NAVSEA  
STANDARD ITEM

FY-24

ITEM NO: 009-53  
DATE: 25 OCT 2022  
CATEGORY: II

1. SCOPE:

1.1 Title: Bolted Bonnet, Globe, Globe Angle, and Globe Stop Check Valve Shop Repair; accomplish

2. REFERENCES:

2.1 S9086-CJ-STM-010/CH-075, Fasteners

2.2 T9074-AS-GIB-010/271, Requirements for Nondestructive Testing Methods

2.3 MIL-STD-2035, Nondestructive Testing Acceptance Criteria

2.4 S9253-AD-MMM-010, Maintenance Manual for Valves, Traps, and Orifices (Non-Nuclear), User's Guide and General Information

2.5 S9086-RJ-STM-010/CH-504, Pressure, Temperature and Other Mechanical and Electromechanical Measuring Instruments

2.6 S9086-RK-STM-010/CH-505, Piping Systems

3. REQUIREMENTS:

3.1 Matchmark each valve part.

3.2 Disassemble, clean each internal and external surface free of foreign matter (including paint), and inspect each part for defects in accordance with Chapter 6 of 2.4.

3.2.1 The removal of body-bound studs only to determine the condition of threads is not required.

(I) or (V) "TORQUE TEST" (See 4.3)

3.2.2 Torque test each body-bound stud in accordance with Section 075-8.6.3.2(d) of 2.1.

3.3 Repair valve as follows:

3.3.1 Straighten stem to within 0.002-inch total indicator reading. Polish stem to a 32 Root-Mean-Square finish in way of packing surface and remove raised edges and foreign matter.

3.3.2 Chase and tap each exposed threaded area.

3.3.3 Clean and spot-in each bonnet to each body gasket mating surface.

3.3.4 Machine, grind, or lap and spot-in discs to seats (including back seat) to obtain a 360-degree continuous contact.

3.3.4.1 Inspect contact using blueing method (soft seated valves excluded).

3.3.4.2 Transfer line for globe valve must not exceed 1/16 inch in width.

(I)(G) "VERIFY LEVEL I PARTS AND CLEANLINESS"

3.4 Assemble valve, installing new each gasket and each fastener for those removed in 3.2 in accordance with the manufacturer's specification or instruction.

3.4.1 Pack each feedwater, condensate and steam valve with each valve stem packing conforming to MIL-P-24503/ MIL-DTL-24583 combination in accordance with Chapter 6 of 2.4.

3.4.2 Pack each valve for systems other than feedwater, condensate, and steam with each valve stem packing conforming to MIL-P24396, type B.

3.5 Hydrostatically test valve as follows:

3.5.1 Hydrostatic test equipment must have the following capabilities:

3.5.1.1 Manual overpressure protection release valve.

3.5.1.2 Self-actuated and resetting relief valve with a set point no greater than 100 PSIG above the test pressure or 10 percent above the test pressure, whichever is less.

3.5.1.3 Master and backup test gauges with gauge range and graduation in accordance with Table 504-6-1 of 2.5. The backup gauge must be cross-checked to the master hydrostatic test gauge up to the maximum test pressure just prior to start of testing. Master and backup gauges must track within 2 percent of each other.

3.5.1.4 Protection equipment must be accessible and test gauges must be located where clearly visible and readable to pump operator and inspector.

(V)(G) or (I)(G) "SEAT TIGHTNESS" (See 4.4)

3.5.2 Test globe valve in the direction tending to open valve.

3.5.2.1 Do not exceed the hand wheel closing force specified in Table 505-11-2 of 2.6.

3.5.2.2 Test must be continued for a minimum of 3 minutes if there is no evidence of leakage, or in the event of visible leakage, until accurate determination of leakage can be made.

3.5.2.3 For each hard seated valve, maximum allowable leakage: 10 cubic centimeters (cc) per hour, per inch of nominal pipe size; 10 cc maximum per hour for valves sizes less than 1-1/2 inches.

(V)(G) or (I)(G) "BACK PRESSURE TEST" (See 4.4)

3.5.3 Back pressure test globe stop check valve with stem in the open position. Allowable leakage as follows:

<u>VALVE SIZE (NOM)</u>	<u>LEAKAGE RATE</u>
Up to 2 inches inclusive	25 cc/hr./in.dia.
2-1/2 inches - 10 inches inclusive	50 cc/hr./in.dia.
Over 10 inches	100 cc/hr./in.dia.

The back pressure applied must be in accordance with the following:

<u>VALVE PRESSURE RATING</u>	<u>TEST BACK PRESSURE</u>
100 PSIG and Below	50 PSIG
Over 150 PSIG	100 PSIG

4. NOTES:

4.1 The test pressures of 3.5.2 will be specified in Work Item.

4.2 Repair of valve operating gear will be specified in Work Item.

4.3 The paragraph referencing this note is considered an (I) if the valve is Level I. If the valve is not Level I, the paragraph is considered a (V).

4.4 The paragraph referencing this note is considered an (I)(G) if the valve is Level I. If the valve is not Level I, the paragraph is considered a (V)(G).

4.5 Test medium will be specified in Work Item.

NAVSEA  
STANDARD ITEM

FY-24

ITEM NO: 009-54  
DATE: 25 OCT 2022  
CATEGORY: II

1. SCOPE:

1.1 Title: Bolted Bonnet, Globe, Globe Angle, and Globe Stop Check Valve In-Line Repair; accomplish

2. REFERENCES:

2.1 S9068-CJ-STM-010/CH-075, Fasteners

2.2 T9074-AS-GIB-010/271, Requirements for Nondestructive Testing Methods

2.3 MIL-STD-2035, Nondestructive Testing Acceptance Criteria

2.4 S9253-AD-MMM-010, Maintenance Manual for Valves, Traps, and Orifices (Non-Nuclear), User's Guide and General Information

3. REQUIREMENTS:

3.1 Matchmark each valve part.

3.2 Disassemble, clean free of foreign matter (including paint), and inspect each part for defects.

3.2.1 The removal of body bound studs only to determine the condition of threads is not required.

(I) or (V) "TORQUE TEST"

3.2.2 Torque test each body-bound stud in accordance with sections 075-8.6.3.2(d) of 2.1.

(I) "LIQUID PENETRANT INSPECT"

3.2.3 Accomplish liquid penetrant inspection of each seat (including back seat), discs or gate in accordance with 2.2.

3.2.3.1 Acceptance criteria must be in accordance with Paragraph 7 of 2.3, except hairline cracks in hard faced areas of seats and discs or gate are acceptable provided the valve does not show evidence of leakage.



3.3 Repair valve as follows:

3.3.1 Straighten stem to within 0.002-inch total indicator reading. Polish stem to a 32 Root-Mean-Square finish in way of packing surface and remove raised edges and foreign matter.

3.3.2 Chase and tap each exposed threaded area.

3.3.3 Clean and spot-in each bonnet to body gasket mating surface.

3.3.4 Machine, grind, or lap and spot-in gate or discs to seats (including back seat) to obtain a 360-degree continuous contact.

(I) or (V) "INSPECT CONTACT" (See 4.3)

3.3.4.1 Inspect contact using blueing method.

3.3.4.2 Transfer line for gate valve must not exceed 3/16-inch in width and must appear within the lower 75 percent of the gate seating surface.

3.3.4.3 Transfer line for globe valve must not exceed 1/16-inch in width.

(I)(G) "VERIFY LEVEL I PARTS AND CLEANLINESS"

3.4 Assemble valve installing new each packing, each gasket, and each fastener for those removed 3.2 in accordance with the manufacturer's specification or instruction.

3.4.1 Pack each feedwater, each condensate, and each steam valve with, valve stem packing conforming to MIL-P-24503/ MIL-DTL-24583 combination in accordance with Chapter 6 of 2.4.

3.4.2 Pack each valve of each system other than feedwater, condensate, and steam with valve stem packing conforming to MIL-P-24396, type B.

4. NOTES:

4.1 Operational test of valve will be specified in Work Item.

4.2 Repair of valve operating gear will be specified in Work Item.

4.3 The paragraph referencing this note is considered an (I) if the valve is Level I. If the valve is not Level I, the paragraph is considered a (V).

NAVSEA  
STANDARD ITEM

FY-24

ITEM NO: 009-55  
DATE: 25 OCT 2022  
CATEGORY: II

1. SCOPE:

1.1 Title: Regulating/Reducing Valve; repair

2. REFERENCES:

2.1 T9074-AS-GIB-010/271, Requirements for Nondestructive Testing Methods

2.2 MIL-STD-2035, Nondestructive Testing Acceptance Criteria

2.3 S9086-RJ-STM-010/CH-504, Pressure, Temperature and Other Mechanical and Electromechanical Measuring Instruments

2.4 S9253-AD-MMM-010, Valves, Traps, and Orifices (Non-Nuclear)

3. REQUIREMENTS:

3.1 Matchmark each valve part.

3.2 Disassemble, clean each internal and external surface free of foreign matter (including paint), and inspect each part for defects in accordance with Chapter 6 of 2.4.

3.3 Repair valve as follows:

3.3.1 Straighten stems and pushrods to within 0.002-inch total indicator reading. Polish stems and pushrods to a 32 Root-Mean-Square finish in way of packing or seal surfaces and remove raised edges and foreign matter.

3.3.2 Chase and tap each exposed threaded area.

3.3.3 Dress and true each gasket mating surface.

3.3.4 Machine, grind, or lap and spot-in metallic discs to seats to obtain a 360-degree continuous contact.

3.3.4.1 Inspect contact using blueing method.

3.3.4.2 Transfer line must not exceed 1/16-inch in width and must appear within the lower 75 percent of the seating surface.

3.4 Assemble valve installing new each packing, each gasket, each diaphragm, each spring, and each soft seat and each fastener for those removed in 3.2 in accordance with manufacturer's specification or instruction.

3.5 Hydrostatically test valve as follows:

3.5.1 Hydrostatic test equipment must have the following capabilities:

3.5.1.1 Manual overpressure protection release valve.

3.5.1.2 Self-actuated and resetting relief valve with a set point no greater than 100 PSIG above the test pressure or 10 percent above the test pressure, whichever is less.

3.5.1.3 Master and backup test gauges with gauge range and graduation in accordance with Table 504-6-1 of 2.3. The backup gauge must be cross-checked to the master hydrostatic test gauge up to the maximum test pressure just prior to start of testing. Master and backup gauges must track within 2 percent of each other.

3.5.1.4 Protection equipment must be accessible and test gauges must be located where clearly visible and readable to pump operator and inspector.

(I) "SHOP TEST"

3.5.2 Test and set valve in shop.

3.5.2.1 Test must be applied for a minimum of 3 minutes.

3.6 Attach a metal tag to valve, stamped with the following information:

3.6.1 Ship name and hull number

3.6.2 Valve number or identification

3.6.3 Valve regulation range and set point

3.6.4 Date valve tested and set

3.6.5 Name of repair facility

4. NOTES:

4.1 Test medium and test pressure for valve inlet and regulated pressure/temperature, must be specified in the invoking Work Item.

- 4.2 Nitrogen or air may be used for shop test of steam valves.
- 4.3 Repairs to pilot control will be specified in Work Item.

NAVSEA  
STANDARD ITEM

FY-24

ITEM NO: 009-56  
DATE: 25 OCT 2022  
CATEGORY: II

1. SCOPE:

1.1 Title: Main Propulsion Boiler Wet Lay-Up; accomplish

2. REFERENCES:

2.1 S9086-GX-STM-020/CH-220, Boiler Water/Feedwater Test and Treatment

3. REQUIREMENTS:

3.1 Accomplish carbohydrazide wet lay-up of each boiler.

3.2 Notify the SUPERVISOR one day prior to lay-up of each boiler.

3.3 Provide the volume of water required to fill each boiler, superheater, economizer, and associated piping by consulting Table 220-22-11 of 2.1. Include an additional 500 gallons for reserve in the total amount required in Table 220-22-11 of 2.1. Water used for lay-up must conform to the following requirements:

<u>CONSTITUENT or PROPERTY</u>	<u>REQUIREMENT</u>
--------------------------------	--------------------

SHORE STEAM AND CONDENSED SHORE STEAM USED AS FEEDWATER

pH	8.0 to 9.5
Conductivity	15 micromho/cm max
Dissolved Silica	0.2 ppm max
Hardness	0.10 epm max
Total Suspended Solids	0.10 ppm max

SHORE PROCESSED FEEDWATER (DEMINERALIZERS, REVERSE OSMOSIS)

Conductivity	2.5 micromho/cm max (at point of delivery)
Silica	0.2 ppm max

3.3.1 The use of filming amines to control steam/steam condensate pH is prohibited.

3.3.2 Provide a pierside tank that will hold the quantity of feedwater required. The tank must be used to mix the carbohydrazide layup solution.

3.3.3 For each 2,000 gallons of feed quality water to be treated, one-gallon of 6.5 percent carbonylhydrazide and 1/2 quart of 40-percent morpholine must be used, in accordance with Paragraph 220-22 of 2.1.

3.3.3.1 Transfer the required amount of carbonylhydrazide and morpholine to a narrow mouthed polyethylene bottle as appropriate to the volume needed. Pour the carbonylhydrazide and morpholine into the tank.

3.3.3.2 Immediately fill the tank with feed quality water to the level calculated in 3.3.

3.3.4 Remove water from the boiler, superheater, and economizer. Close boiler drains and openings with the exception of steam drum, superheater, and economizer vents.

3.3.5 Immediately fill the boiler, including superheater and economizer, taking suction from the carbonylhydrazide lay-up solution treated tank.

3.3.5.1 While filling the boiler, close each vent in turn as the treated water overflows. After the boiler is filled as shown by an overflow from the highest vent, crack each lower vent in turn to ensure that there are no trapped air pockets.

3.4 Maintain positive pressure on each boiler, not to exceed 150 PSIG, using a head tank, or shore steam in accordance with Paragraph 220-1.1 of 2.1.

3.5 Determine the carbonylhydrazide concentration on the day each boiler is placed under lay-up and weekly thereafter.

3.5.1 Draw a sample through the boiler water sample line after allowing the boiler water to flow for 5 minutes to flush the line. Rinse the sample bottle with boiler water sample prior to filling. Allow the sample bottle to overflow before capping the bottle to eliminate trapped air.

3.5.1.1 Determine the carbonylhydrazide concentration immediately after sampling.

3.5.1.2 If the carbonylhydrazide concentration falls below 2.0 ppm, the layup is lost and the boiler must be dumped and retreated or changed to an authorized layup.

3.6 Drain the superheater and bring each boiler to operating level. Dispose of removed solution in accordance with local, state, and federal regulations.

3.6.1 Do not drain the solution to the bilge.

#### 4. NOTES:

4.1 None.

NAVSEA  
STANDARD ITEM

FY-24

ITEM NO: 009-57  
DATE: 25 OCT 2022  
CATEGORY: II

1. SCOPE:

1.1 Title: Reduction Gear Security; accomplish

2. REFERENCES:

2.1 Standard Items

2.2 S9086-H7-STM-010/CH-262, Lubricating Oils, Greases, Specialty Lubricants, and Lubrication Systems

2.3 S9086-HK-STM-010/CH-241, Propulsion Reduction Gears, Couplings, Clutches, and Associated Components

3. REQUIREMENTS:

3.1 Accomplish the requirements of Paragraphs 262-3.5.6 and 262-3.5.7 of 2.2 to prevent entry of foreign matter into the lube oil system during work accomplished by the Work Item.

3.1.1 Notify the ship's Engineering Officer via the SUPERVISOR before opening and closing each main reduction gear or main reduction gear attached components.

3.1.2 Accomplish the requirements of Paragraph 241-3.5.2 of 2.3 to prevent rust/moisture damage to components when the reduction gear is going to remain inoperative in excess of 2 weeks.

3.2 Remove and dispose of system fluids to accomplish the requirements of the Work Item.

3.3 Provide and install temporary machinery protection in accordance with Paragraph 241-6.1.1.m of 2.3 and the following requirements:

3.3.1 Establish a limited access area and the physical boundary of the security control area.

3.3.2 The security control area must be established prior to and maintained during the time an access to the reduction gears (including the main reduction gear [MRG] case, MRG sump, lube oil [LO] lines which terminate in the MRG, or LO cooler) is opened.

(V)(G) "INSPECTION/APPROVAL OF SECURITY CONTROL AREA"

3.3.3 Notify the SUPERVISOR prior to opening any clean system or component within the area. The SUPERVISOR must inspect and approve the security control area prior to start of work.

3.3.4 Maintain on site Accountability Logs, Attachments A and B, of all tools, equipment, and personnel entering and leaving the security control area to verify adherence to the requirements set forth in 3.7 and 3.8.

3.3.4.1 Inspect the log at the beginning and end of each shift to ensure that it describes the equipment and tools within the security control area.

3.3.4.2 Use Attachment A to log all tools, equipment, and personnel.

3.3.4.3 Use Attachment B for shift turnover verification.

3.3.5 Post warning signs at the entry points to the security control area and limited access area to maintain control of the area and inform personnel that the reduction gear is open.

3.3.5.1 Set up Limited Access Area with rope/line and signs to restrict unnecessary traffic.

3.3.6 Provide 24-hour continuous on-site surveillance by contractor personnel in the area as long as the reduction gear is exposed.

3.3.6.1 Policing of limited access area must be routine while gear is exposed or systems which flow into the MRG are open (e.g., propulsion lube oil [PLO] system, dehumidifier, vent fog precipitator [VFP]).

3.4 Observe Ship's Force security control/accountability measures.

3.5 Provide reduction gear security in accordance with Paragraph 241-4.2 of 2.3 during periods that require the gear train to be exposed from access openings where direct or indirect paths to gearing will result.

3.5.1 Notify the ship's Engineering Officer or designated representative prior to disassembly and removal of the following gear casing components:

3.5.1.1 Hinged, pinned, or bolted gear casing covers, inspection ports, and plates

3.5.1.2 Sight flow indicators, gear mesh spray nozzles, thermometers, and associated fittings

3.5.1.3 Oil supply and return piping, vent lines, fittings, and plugs.

3.5.2 The ship's Engineering Officer or designated representative must be present at all times when external connections are attached to the reduction gear casing, oil sump, and oil piping.



3.5.3 The surrounding limited access area must be secured and policed to remove overhead or local dirt, loose objects, or any potential security violating objects prior to and during gear exposure.

(V)(G) "PRE-OPENING CLEANLINESS"

3.5.4 Prior to opening casing, ensure no foreign material exists on adjacent surfaces that could contaminate the internal areas upon lifting casing covers, piping, and associated equipment.

3.5.5 Construct a temporary cover over openings of the gear train, in addition to the required limited access area controls, if it becomes necessary to stop work with the casing/covers removed.

3.6 Protective coverings:

3.6.1 When repairs require the removal of main bolted cover plates, assemble an enclosure made from Herculite or canvas covering conforming to A-A-55308 over the top of the reduction gear housing, lashing the bottom of the enclosure to the deck structure or piping at deck level.

3.6.1.1 Snaps, staples, or similar must not be used on enclosure. Utilize heavy duty zippers and Velcro hook-pile. Secure all grommets attached to enclosure with line or lanyard to prevent loss of grommets.

3.6.1.2 Lash the top edge of the enclosure to overhead structural members to form a work area over and around the reduction gear casing.

3.6.1.3 Lace the top flaps to the sides. The top must utilize a center joint if lifting gear is utilized. Unlace center joint when utilizing lifting gear.

3.6.1.4 Lace all but one of the corners to each other, utilizing stiffeners, to form a secure work area. The unlaced corner must be used for a security door constructed to be capable of being secured. Stencil "CONTROLLED AREA – AUTHORIZED PERSONNEL ONLY" on the sides and top of the enclosure or install signs at enclosure boundaries.

3.6.2 When repairs do not require removal of main bolted cover plates, protect planned open and accessible areas of the reduction gear by assembling an enclosure made from Herculite or canvas covering conforming to A-A-55308.

3.6.2.1 Submit one legible drawing or sketch of proposed enclosure(s) to the SUPERVISOR 5 days prior to entering the reduction gear. Drawing must include enclosure access for installation of lifting gear (if required).

3.6.2.2 Snaps, staples, or similar must not be used on enclosure. Utilize heavy duty zippers and Velcro hook-pile. Secure all grommets attached to enclosure with line or lanyard to prevent loss of grommets.

3.6.2.3 Stencil “CONTROLLED AREA – AUTHORIZED PERSONNEL ONLY” on the sides and top of the enclosure or install signs at enclosure boundaries.

3.6.3 An enclosure is not required for work involving temporary MRG dehumidifier systems and extended lay-up. For work involving temporary MRG dehumidifier systems and extended lay-up in 3.1.2, ensure 3.3.5 and 3.3.5.1 are accomplished.

3.7 Prepare an Accountability Log, Attachment A and B, immediately after limited access area has been approved by the SUPERVISOR, but prior to opening an access. Maintain the Accountability Log while reduction gears and attached components are open.

3.7.1 Station a Control Watch at the enclosure door/flap and maintain Attachment A for all material and hardware which is small enough to fit inside access opening.

3.7.2 The Control Watch must record the date and time in the appropriate block on Attachment B each time accountability is started or stopped, and each time access is opened or closed. Any time the log is turned over to another Control Watch, both the outgoing and incoming Control Watches must sign Attachment B to document that all items are accounted for.

3.7.3 Any material permanently or temporarily installed must be noted as such in the remarks column on Attachment A.

3.8 Inspection equipment, tools, and personnel clothing must be captured, secured, and accounted for to preclude introduction of foreign matter into the reduction gear.

3.8.1 Acceptable methods of capturing are:

3.8.1.1 Drilling and lockwiring

3.8.1.2 Tackwelding or silver brazing

3.8.1.3 Using nylock-type locking devices

3.8.1.4 Upsetting or staking threads

3.8.1.5 Attaching a lanyard

3.8.1.6 Taping with duct tape

3.8.2 All personnel working in or around an open gear casing must have all eye glasses, buttons, zippers, and other loose items on their clothing properly taped to prevent them from breaking loose and falling into the gear casing. All jewelry, pens, change, metal objects, loose items, etc., must be removed from the person and clothing pockets prior to entering area.

3.9 Notify the SUPERVISOR in all matters involving foreign material retrieval from the reduction gear. Report all incidents breaching reduction gear security to the ship's Engineering Officer or Engineering Duty Officer via the SUPERVISOR.

(V)(G) "INSPECTION PRIOR TO CLOSURE"

3.10 Accomplish a visual inspection of the exposed reduction gear and associated components prior to each closing (daily and final). Ensure no foreign matter has entered or remains within the reduction gear and/or components. Inspect each ledge, including the underside of ledge, pocket, gear tooth, and bearing journal and bearing cap, using mirrors, periscopes, and borescopes.

3.10.1 The inspection must be made jointly with the SUPERVISOR and the ship's Engineering Officer or designated representative.

3.10.2 Prior to each closing verify that all tools and equipment listed on Attachments A and B have been either logged out satisfactorily or are annotated as installed, permanently or temporarily, in the remarks column.

3.10.2.1 Accountability must stop when the access is closed.

3.10.3 Attachments A and B must be available for review by the SUPERVISOR at time of final closure.

3.10.3.1 Submit one legible copy, in hard copy or approved transferrable media, of completed Attachments A and B to the SUPERVISOR within 2 days of final closure.

3.11 Disassemble and remove the enclosure and limited area boundary when directed by the SUPERVISOR.

3.12 Accomplishment of cleaning and painting for new and disturbed surfaces must be in accordance with NAVSEA Standard Items (See Note 4.3).

4. NOTES:

4.1 In support of emergency inspections, limited inspections or minor repairs to the propulsion reduction gear, the requirements for a security control area may be omitted at the discretion of the SUPERVISOR with the concurrence of the ship's Engineering Officer. If the security control area is precluded during these special circumstances, the security of the reduction gear must be maintained.

4.1.1 The requirements for contractor accountability cannot be waived.

4.2 Definitions of terms used are:

4.2.1 Clean Work Area: An area requiring a cleanliness/ accountability level at least equal to that required for in-shop repair of similar equipment to permit the easy recovery of any dropped tools, material, etc. This area must be free of excess moisture and contaminants, i.e., abrasive materials resulting from blasting, grinding, or other particle generating processes. Areas where this condition would apply are inspection and/or access covers removed or open.

4.2.2 Security Control Area: An area or enclosure that provides a physical boundary around access opening (Herculite) which will preclude the inadvertent introduction of any uncontrolled personnel, tools, equipment or foreign material. This area must always meet

the requirements of a Clean Work Area and can be upgraded to a Limited Access/Exclusion Area. A Controlled Area must always require Physical Separation.

4.2.3 Full Enclosure: An enclosure that has all edges (sides, top, and bottom) secured with cabling that is woven through grommets and secured to stanchions, foundations, deck grating, etc. The enclosure will be considered adequately secured if a person cannot enter through any opening other than the designed entry accesses.

4.2.4 Limited Access Area: An area requiring the maximum level of concern and accountability for personnel and material. During this condition a Full Enclosure is required. This type of area isolation is required where the recovery of dropped or broken material would be difficult and/or requires extensive rework of the task in progress. The Full Enclosure must be locked when unattended by production and during the unattended time keys must be controlled by the Ship's Engineering Office. An area established outside the security control area to limit the personnel allowed to enter the reduction gear area and is intended to prevent unnecessary traffic.

4.2.5 Accountability: The method used to maintain foreign material exclusion from reduction gears by keeping a formal record (accountability log) of all materials, including tools and hardware that may pass through access opening.

4.3 If cleaning and painting for new and disturbed surfaces of 3.12 are required; the use of Category II Standard Item 009-32 "Cleaning and Painting Requirements; accomplish" of 2.1 will be specified in the Work Item.

ATTACHMENT A  
ACCOUNTABILITY LOG

SHEET \_\_\_\_\_ OF \_\_\_\_\_

SHIP/HULL \_\_\_\_\_ SPEC. ITEM \_\_\_\_\_ SYSTEM-LOCATION \_\_\_\_\_

Item No.	Personnel Name/Item Description	Entered Area (Note 1)			Exited Area (Note 2)			Remarks (Note 3)
		Qty of Item (N/A for Personnel)	Date/Time	CTRL Watch*	Qty of Item (N/A for Personnel)	Date/Time	CTRL Watch*	

\* The person designated to sign for an action verifies, based on personal observation, and certifies by their signature that the action has actually been performed in accordance with the specified requirements.

Note 1: Verify personnel and material entering area meet the requirements of 3.8

Note 2: Existing material removed shall be documented with "Entered Area" marked "N/A".

Note 3: Record if item is temporarily or permanently installed in system per para 3.7.3. Include additional remarks as required for clarification.

ATTACHMENT B  
ACCOUNTABILITY LOG (WATCH TURNOVER VERIFICATION)

SHIP/HULL \_\_\_\_\_ SPEC. ITEM \_\_\_\_\_ SYSTEM-LOCATION \_\_\_\_\_

Logged items remaining within the exposed location at the change of watch shall be verified present by the in-coming and out-going control watches. This verification shall be accomplished by physically checking the area and confirming those items required to be logged. Both the outgoing and incoming watches shall sign the watch turnover verification to certify that the remaining items have been physically verified, no unnecessary items are left in accountability area, containments are satisfactory, and area is cleaned.

Ctrl Watch Name	Date/Time Started	Date/Time Stopped	Date/Time System Open	Date/Time System Closed	Logged items on Attachment A verified at watch turnover		Remarks
					Off Going watch signature*	On Coming watch signature*	

THIS LOG IS CLOSED. ALL ITEMS ARE ACCOUNTED FOR AS INDICATED.

Inspector\*\* \_\_\_\_\_ Date/Time \_\_\_\_\_ Supervisor\*\* \_\_\_\_\_ Date/Time \_\_\_\_\_

\* The person designated to sign for an action verifies, based on personal observation, and certifies by their signature that the action has actually been performed in accordance with the specified requirements.

\*\* The person designated to sign for an action verifies, based on personal observation or certified records, and certifies by their signature that the action has been performed in accordance with the specified requirements.

NAVSEA  
STANDARD ITEM

FY-24

ITEM NO: 009-58  
DATE: 25 OCT 2022  
CATEGORY: II

1. SCOPE:

1.1 Title: Pump and Driver Shaft Alignment; accomplish

2. REFERENCES:

2.1 S6226-JX-MMA-010, Instruction Manual for the Indicator Reverse Method of Pump Shaft Alignment

2.2 803-6397419, Standard Machinery Shim Kits

3. REQUIREMENTS:

3.1 Measure pump and driver shaft alignment using the indicator reverse method and the mathematical equations or graphs or alignment computer or laser based measuring instruments in accordance with 2.1.

3.1.1 Determine soft foot and correct in accordance with Section 2-2, 2-6.5.13 or 2-6.6.18 of 2.1. Shims must be in accordance with 2.2.

3.2 Inspect piping alignment in accordance with Section 2-3 of 2.1 prior to removal.

3.2.1 Submit one legible copy, in hard copy or approved transferrable media, of a report listing results of the piping alignment check to the SUPERVISOR within 3 days of completing the disassembly alignment check.

(V)(G) "INSPECT PIPING ALIGNMENT AT INSTALLATION"

3.3 Inspect piping alignment in accordance with Section 2-3 of 2.1 at installation.

3.4 Measure indicator sag in accordance with Section 2-4 of 2.1.

(V)(G) "COLD ALIGNMENT" (See 4.4)

3.5 Align each shaft to the offset and angular alignments in accordance with the cold alignment settings invoked in the Work Item (see 4.1). Cold alignments for horizontally mounted machinery must be accomplished in accordance with Chapter 2, Sections 2-1 through 2-7 of 2.1, and vertically mounted machinery must be in accordance with Chapter 5, Sections 5-1 through 5-3 of 2.1. Pumps/motors with magnetic couplings must be aligned in accordance with

2.1. The results of this section must be used to complete the alignment data collection form (Page 7.2 of 2.1) (See 4.5).

3.5.1 If hot alignment is not required, complete cold final alignment verification. Accomplish a final alignment check of pump with dowels installed.

3.5.1.1 Fit and install new chocks and shims conforming to ASTM A 240 to accomplish alignment. Shims must be in accordance with 2.2.

3.5.1.2 Drill and ream foundations. Fit and install new SAE-AMS-QQ-S-763, Grade 304, dowels in each unit to retain final satisfactory unit alignment in accordance with Section 2-8 of 2.1.

3.5.2 Submit one legible copy, in hard copy or approved transferrable media, of a completed alignment data collection form (Page 7-2 of 2.1) (see 4.5) for the results of the requirements of 3.5 to the SUPERVISOR.

3.6 Align shafts so that offset and angular alignments are acceptable when the unit is hot. Acceptable alignment tolerances must be based on the rated speed of the pump and the alignment tolerance listed in Table 1-1 of 2.1 (see 4.2). Hot alignments for horizontally mounted turbine-driven machinery must be accomplished in accordance with Chapter 2, Section 2-1 through 2-8 of 2.1. Hot alignment is not required for vertically mounted machinery unless specified in the unit's technical manual. Hot alignment is not required for horizontally mounted, motor-driven machinery. Accomplish hot alignment check only on units when the cold alignment has been compensated for thermal growth. (Hot alignment readings must be taken within 30 minutes of shutting down unit).

3.6.1 Fit and install new chocks and shims conforming to ASTM A 240 to accomplish alignment. Shims must be in accordance with 2.2.

3.6.2 Drill and ream foundations. Fit and install new SAE-AMS-QQ-S-763, Grade 304, dowels in each unit to retain final satisfactory unit alignment in accordance with Section 2-8 of 2.1.

(V)(G) "FINAL HOT ALIGNMENT"

3.7 Accomplish a final hot alignment check of pump in accordance with 2.1 with dowels installed.

3.7.1 Submit one legible copy, in hard copy or approved transferrable media, of a report listing results of the requirements of 3.7 to the SUPERVISOR. The report must include the completed alignment data collection form (page 7-2 of 2.1) (see Note 4.5) for final hot alignment condition.

4. NOTES:



4.1 Reference that contains the cold setting alignment will be identified in the invoking Work Item.

4.2 Hot alignment criteria if different from zero will be identified in the invoking Work Item.

4.3 Turbine driven unit must be run a minimum of 2 hours to achieve operating temperature.

4.4 (V)(G) of 3.5 is invoked only when hot alignment is not required.

4.5 If utilizing laser based measuring instruments, a completed results printout may be utilized in lieu of Page 7-2 of 2.1.

NAVSEA  
STANDARD ITEM

FY-24

ITEM NO: 009-60  
DATE: 25 OCT2022  
CATEGORY: I

1. SCOPE:

1.1 Title: Schedule and Associated Reports for CNO Availabilities; provide and manage

2. REFERENCES:

2.1 Standard Items

2.2 S9AA0-AB-GOS-010, General Specifications for Overhaul of Surface Ships

3. REQUIREMENTS:

3.1 Develop one legible copy in Gantt Chart format of an Integrated Production Schedule (IPS) using Critical Path Method (CPM) Network Analysis principles, tools, and practices that reflects accurate scheduling data for each key event and milestone using automated Network Analysis tools in accordance with the following requirements:

3.1.1 Include Key Events, Milestones, tests, and work being accomplished by Alteration Installation Teams (AITs), Government-Contracted Third Party Maintenance Providers, Ship's Force (S/F), Commercial Industrial Services (CISs), and Fleet Maintenance Activities (FMAs).

3.1.1.1 Alteration (ALT) numbers, Job Sequence Numbers (JSNs), and Task Order numbers (TOs) are considered equivalent to the contractor's Work Specification Work Items for the purposes of scheduling the work of these third-party organizations in accordance with this Standard Item.

3.1.1.2 The term Work Item is inclusive of these additional methods of identifying a body of work.

3.1.1.3 When calling out the Key Events for any Work Activity, the following KE acronyms shall be used - AC, C5ILO, DT, FC, UD, PCD, WC, and ST.

3.1.2 Schedule each Work Item to the Work Activity level, listing the planned start and planned completion dates, and durations in full days for each Work Activity.

3.1.2.1 Assign each Work Activity with the appropriate predecessor and successor relationships within the contractor's scheduling software that establish the logic

relationship between schedule Work Activities. Each activity must have at least one predecessor and one successor, with the exception of the Key Event Start Availability (which may have no predecessors) and the Key Event Complete Availability (which may have no successors). Each Event and Activity may have more than one predecessor and more than one successor. The majority of relationships within the detailed schedule should be Finish-Start however, work that is concurrent or in parallel should be scheduled as start-start or finish-finish accordingly. The use of scheduling Lags and Leads must be minimized.

3.1.2.2 Assign appropriate predecessor relationships to each Key Event and Milestone(s) to ensure there is an accurate logical progression through all work activities leading to their assigned Key Event and Milestone(s), ensure milestones are linked to the Key Events they support, and ensure the IPS supports accurate prediction of Key Event and Milestone(s) attainment.

3.1.2.3 Assign appropriate predecessor and successor relationships between the Work Activities conducted on the same component, or in the same location but under differing Work Items, to ensure all related Work Activities across all Work Items are interdependently linked together.

3.1.2.4 Schedule Stage 2 Weight Tests and Hydrostatic Tests, and all Stage 3 through Stage 6 required tests as Work Activities by Work Item. Include the predecessor/successor relationships between tests, the production work, and system restoration required to manage work-to-test progression. Test Stages are defined in Section 092 of 2.2.

3.1.2.5 The use of hard constraints is limited to contractually-defined Key Events and milestones. Each contractually-defined Key Event and Milestone will have a constraint assigned in order to lock their date to the current contractual or government approved date.

3.1.2.6 The contractor is permitted, to include contract changes (growth, descopes, and new work) within the integrated production schedule prior to settlement of the associated change. All changes incorporated prior to settlement must be clearly denoted by the word "pending" in the title, in accordance with TABLE 1.

3.1.2.7 Descope activities must remain in the schedule until settlement of the associated change. Corresponding hours and schedule logic may be removed and or updated accordingly.

3.1.2.8 In execution of the availability, the contractor may allow dates to exceed the contract period of performance. This does not constitute government approval of a change to the end of availability.

3.1.2.9 When required by contract, the LMA will be required to lead a Schedule Model Review (SMR). See note 4.1.31.

3.1.3 Schedule production work and preliminary inspections generating reports required by 2.1 or the Work Item, that could result in a change in work to be accomplished or

additional material to be procured, to support reporting no later than the first 20 percent of the availability duration.

3.1.3.1 Schedule dry dock, or dry berth for Navy boats and craft, related inspections generating reports required by 2.1 or the Work Item to support reporting no later than the first 20 percent of the scheduled docking or dry berth period.

3.1.3.2 When the Required O&I Reports present a sequencing conflict that would prevent one or more reports from being accomplished by the 20 percent O&I Milestone (e.g., stability, work integration, etc.), additional milestones will be created based on when they could be accomplished, and the lower priority conflicted Required O&I Reports will be associated to those new milestones. (See NOTE 4.1.33)

3.1.4 Schedule production work final inspections and testing for work that has to be completed prior to pre-flood/undocking and which generates technical data requiring Government review to complete no later than four days prior to the scheduled undocking (when applicable) or provide a technical justification for not meeting this requirement.

3.1.5 Develop the Schedule of Record (SOR) to serve as the “baseline” schedule, a revised IPS at the start of the availability (A-0 day) that includes refined sequencing and completeness as a result of completed subcontracting actions, incorporation of additional Government Furnished Information (GFI), or any contract modifications increasing the scope of work between contract/delivery Order award and availability start. The baseline will be maintained to reflect contract changes (RCCs and descopes) throughout availability execution. Deviations from contractually authorized dates will be addressed in the mitigation plan. Mitigation measures must be formulated prior to the next weekly update of the IPS, but in no case exceed two weekly IPS update cycles.

3.1.6 Revise Weekly IPS at the Work Activity level to include additions, deletions, modifications, actual start and finish dates, progress, and completions. Progress must be based on degree of completion of physical work or accomplishment of the Work Activity.

3.1.6.1 Reassign Milestone and Key Event relationships for incomplete Work Activities when the associated Milestone or Key Event has passed and the Work Activity was authorized as an exception. All other reassignments of Milestone or Key Event relationships must be approved by the SUPERVISOR prior to implementation in the IPS.

3.1.6.2 Activities projected to finish after their assigned Key Event or Milestone date, either by scheduling software-calculated date or by the accumulation of negative float, must be identified and a mitigation plan must be developed. Mitigation measures must be formulated and documented in report in accordance with 3.4 prior to the next weekly update of the IPS, but in no case exceed two weekly IPS update cycles.

3.1.6.3 When attainment of each Milestone or Key Event is projected to finish after their planned completion dates as a result of settled contract scope, corrective action must be taken through resource allocation, rescheduling, or other means, to restore predicted Milestone or Key Event attainment within contractually authorized dates. Where the attainment

of a contractually-defined Key Event or Milestone cannot be recovered by means that are within the contractor’s control, comply with the reporting requirements of 009-01 of 2.1.

3.1.7 Include the following minimum data elements for each Work Activity in the schedule, as appropriate. Elements listed in Table 1 are not required to be displayed in ADOBE PDF views of submitted IPS unless otherwise directed in this Standard Item.

Table 1  
Activity Data Elements and Descriptions

Data Element	Description
Work Item Number (as appropriate)	4-E specification Work Item number
Work Activity Identifier	Numerical designator identifying the Work Activity within the Work Breakdown Structure (WBS)
Title	Descriptive title of Work Item and Work Activity
ICN / Task Number (as appropriate)	Industrial Control Number (ICN): AIM/PSS system identifier for naval shipyard and FMA work and for private shipyards the unique identifier (Task Number) from AIT, Government-Contracted Third Party Maintenance Providers, S/F, CIS, FMA, and other maintenance providers Plan of Actions and Milestones (POAM).
Key Event	Key Event applicable to the Work Activity (See 4.4)
Milestone (as appropriate)	Milestone applicable to the Work Activity
System (as appropriate)	System(s) affected (See 4.5)
Component (as appropriate)	Component Unit (For example: tank, valve, motor, pump)
Location	Work location/individual tank/compartament number (See 4.6)
Executing Activity	ID specific organization: Prime KTR, Sub-KTR, FMA, SMMO, AIT, or OSIC
Superintendent or Zone Manager	Responsible Contractor Superintendent or Zone Manager
Baseline Start	The Baseline start date identified on the current IPS. (See 4.1.15)
Baseline Finish	The Baseline finish date identified on the current IPS. (See 4.1.15)
Early Start	Software determined date (See 4.1.18)
Early Finish	Software determined date (See 4.1.19)
Late Start	Software determined date (See 4.1.20)
Late Finish	Software determined date (See 4.1.21)
Actual Start	Actual date for the Work Activity’s start
Actual Finish	Actual date for the Work Activity’s finish
Percent Complete (Planned)	Degree of completion based on the Work Activity planned work scope and planned degree of accomplishment of production labor. Based on the Project Baseline.
Percent Complete (Actual)	Degree of completion based on the Work Activity’s work scope and degree of accomplishment of production labor.
Duration	The total number of work periods required to complete a Work Activity.
Calendar Identification	Number of scheduled workdays per week

Total Float	The total number of workdays that the Contractor can delay a Work Activity without affecting the project finish date.
Predecessor	An Activity or Event that immediately precedes one or more Activities or Events with a direct tie in the Total Project Network. Every Activity and Event in the Total Project Network must have at least one Predecessor (except Start Availability).
Successor	An Activity or Event that immediately follows one or more Activities or Events with a direct tie in the Total Project Network. Every Activity and Event in the Total Project Network must have at least one Successor (except Complete Availability).
Constraints	Constraints used as applicable to Work Item or Work Activity. This may be provided within the predecessor or successor field.

3.1.8 Develop an export of the IPS data elements in a sortable/filterable spreadsheet format compatible with Microsoft Excel. The spreadsheet must include a column for each of these elements laid out in the order presented in table one from left to right. For AIT Installed alterations the Alt Type and Number should be entered in the Work Item Number field.

3.2 Display the IPS in a time-oriented Gantt chart format that shows only Critical Path and Controlling Work Items at the Work Activity level and assigned Key Events and/or Milestones.

3.2.1 Revise the Gantt Chart weekly in conjunction with the weekly IPS revisions of 3.1.6.

3.3 Develop a Critical Path Network in Precedence Diagram Method (PDM) format that displays only the Critical Path sequences of the availability with associated Key Events and Milestones. Display Critical Path at the Work Activity level to provide visual representation of the logic relationships between displayed Work Activities.

3.3.1 The network or any sub-network thereof may be continued on additional pages.

3.3.2 Label each Work Item, Work Activity, Milestone, and Key Event of the network with each Activity box on every Precedence Diagram must contain the following data elements of 3.1.8: Work Item Number, Activity Title, Early Start Date or Actual Start Date, if Started, Early Finish Dates or Actual Finish Date, if finished, Original Duration, Percent Complete, Calendar Identification, and Total Float.

3.3.3 Update the project’s PDM for the 25, 50 and 75 percent points of the availability.

3.4 Provide Schedule Analysis Reports.

3.4.1 Generate a Key Event and Milestone Analysis Report that includes the following information for each Key Event and contractually-defined Milestone: Event Type

(Key Event/Milestone), Title, Work Activity Identifier, Original Schedule Date, Revised Schedule Date, Actual Completion Date, Projected Finish Date, (inclusive of accounting for negative float), and analysis/actions.

3.4.1.1 The revised schedule date and actual date of accomplishment must be left blank on the initial submission and filled in to reflect actual conditions on subsequent submission of the report.

3.4.1.2 Revise the Key Event and Milestone Analysis Report weekly to reflect up-to-date contract performance. Address Work Items on the Critical and Controlling Path with negative float to Key Events and Milestones in accordance with 3.1.6.3. The report must reflect the addition, deletion, or modification of settled and pending Work Item changes.

3.4.2 Generate a Schedule Health Report that includes the following information: Number of incomplete activities with missing logic; Finish-to-Start Percentage; Number of incomplete activities with negative float; Number of incomplete activities with high duration; Throughput Percentage. Parameters exceeding threshold values require explanation. Submit Schedule Health Report with the Initial IPS, SOR, and at the 25, 50, and 75 percent progress of the availability. (See 4.1.29, for report element description and threshold values).

3.5 Provide manpower management information using Attachment A.

3.5.1 Develop a total manpower-loading curve depicting the forecasted manning required to execute the IPS. Show scheduled manning throughout the contract period calculated in Full Time Equivalents (FTEs). The curve must indicate that portion of the total that is subcontractor provided. The curve must be incremented on a weekly progression.

3.5.1.1 Manning values must reflect actual FTEs expended. Future requirements must reflect weekly average FTE estimated to complete the project, scheduled using the early start/finish dates.

3.5.2 Develop separate manpower curves showing scheduled manning by trade throughout the contract period calculated in FTE. The curves must indicate that portion of the total that is subcontractor provided. The curves must be incremented on a weekly progression.

3.5.2.1 Manning values must reflect actual FTEs expended. Future requirements must reflect weekly average FTE estimated to complete the project, scheduled using the early start/finish dates.

3.5.3 Update the manpower curves of 3.5.1 and 3.5.2 weekly to accurately reflect the actual FTE expended and any changes necessary in future weeks' manpower requirements to meet scheduled Milestones, Key Events and vessel delivery.

3.5.4 Develop a weekly progress report showing the availability's planned and actual progress.

3.5.4.1 The weekly progress report must indicate the total hours, within the 3.5.1 Manpower Loading Curve, which are attributed to work pending descope and pending growth RCCs. This must not include unallocated LOE to completion.

3.6 Provide a representative whose function is to coordinate and schedule AIT, Government-Contracted Third Party Maintenance Providers, S/F, CIS, and FMA work with contractor work into the IPS.

3.6.1 The representative must meet with the SUPERVISOR, AIT, Government-Contracted Third Party Maintenance Providers, S/F, CIS, and FMA between contract award and A-0. Commencing at A-0, this engagement must occur daily to compare and coordinate programmed AIT, Government-Contracted Third Party Maintenance Provider, S/F, CIS, and FMA work with the IPS.

3.6.2 Coordinate AIT, Government-Contracted Third Party Maintenance Provider, S/F, CIS, and FMA work integration into the IPS prior to setting the Schedule of Record (SOR). (See 4.1.22).

3.6.2.1 The representative must develop a report identifying missing or incomplete schedule integration data for known participants in the availability when the SOR is submitted. Identification of missing or incomplete schedule integration data is required to highlight areas of elevated IPS uncertainty, but must not be cause for delay in establishing the SOR nor the delivery of reports required under this Standard Item.

3.6.3 Incorporate updated progress from AIT, Government-Contracted Third Party Maintenance Providers, S/F, CIS, FMA, and other maintenance providers into the IPS.

3.6.3.1 Provide a common template in Microsoft Excel compatible format to facilitate submission of progress updates of 3.6.3.

3.6.4 Identify, at the weekly progress meeting, schedule conflicts where programmed AIT, Government-Contracted Third Party Maintenance Provider, S/F, CIS, and FMA work interferes with previously scheduled contractor work.

3.6.5 Identify, at the weekly progress meeting, required AIT, Government-Contracted Third Party Maintenance Provider, S/F, CIS, and FMA prerequisite actions necessary to support contractor testing and equipment operation schedule.

3.7 Provide cognizant shipyard management representation to participate in the weekly progress meeting at the time and location agreed to by the SUPERVISOR. The representative(s) must be authorized to make management decisions relative to the routine requirements, implementation of corrective actions for each schedule shortfall that, in good faith, commit the contractor. Discussion will include the Schedule Analysis of 3.4 and each work item of concern.

3.8 Participate in review conferences at the 25, 50, and 75 percent points in the availability. Data from the most recent submission in accordance with 3.9.3 will be used at the review conferences. Review conferences will be held within 2 days of the Weekly progress Meeting of 3.7 or, subject to SUPERVISOR approval, may be held simultaneously with the



Weekly Progress Meeting. The conferences will be scheduled at a time and place mutually agreeable to all parties. The contractor must:

3.8.1 Be prepared to discuss planned production manning versus actual production manning by total, trades, and subcontractors.

3.8.2 Identify known factors that may affect Key Events, Milestones and the contract completion. Provide recommended courses of action to resolve problem areas.

3.8.3 Provide the SUPERVISOR with the status of open and inspect reports and be prepared to discuss possible impact of growth work in these items at the 25 percent review conference.

3.8.4 Provide the SUPERVISOR with the following information for the 50 percent review conference:

3.8.4.1 A machinery reinstallation plan showing projected dates for installing the equipment on the foundation, hook-up of the equipment, and operational tests of the equipment.

3.8.4.2 A valve status list showing projected completion and reinstallation dates.

3.8.4.3 A list of items required for the next Key Event and Production Completion Date (PCD) that are not complete. Annotate those items on the list that may be in jeopardy of completing by the next Key Event and PCD.

3.8.5 Provide the SUPERVISOR with one legible copy, in approved transferrable media, of a test schedule for all planned underway equipment and system testing to the SUPERVISOR to support the 75 percent review conference.

3.9 Submit the following reports as listed in Adobe Acrobat (.pdf), Microsoft Excel (.xls), or Microsoft Word (.doc) compatible media as per Table 2 and Table 3:

Table 2  
Deliverables.

Para. Number	Requirements	Title	Format	Due
3.9.1	3.1 3.1.8 3.2 3.4.2	Initial IPS -Gantt chart -Spreadsheet -Critical Path (Gantt) -Schedule Health Report	*.pdf *.xls *.pdf *.doc or *.xls	Based on contract type as listed in Table 3
3.9.2	3.1 3.1.8 3.2 3.3 3.4.2 3.5.1	Schedule of Record -Gantt chart -Spreadsheet -Critical Path (Gantt) -Critical Path Network (PDM) -Schedule Health Report -Manpower Curves (Total)	*.pdf *.xls *.pdf *.pdf *.doc or *.xls *.xls	A-0

	3.5.2 3.6.2.1	-Manpower Curves (Trades) -Incomplete GFI	*.xls *.doc	
3.9.3	3.1.8 3.2 3.4 3.5.1 3.5.2 3.5.4 3.6.2.1	Weekly IPS -Spreadsheet -Critical Path (Gantt) -Schedule Analysis (less 3.4.2) -Manpower Curves (Total) -Manpower Curves (Trades) -Progress Report -Incomplete GFI	*.xls *.pdf *.doc or *.xls *.xls *.xls *.xls *.doc	Weekly after A-0, 24 hrs prior to weekly progress meeting
3.9.4	3.1.6 3.3 3.4.2	25 Percent Conference Support -Gantt Chart (Most recent Revised Weekly IPS) -Critical Path Network (PDM) -Schedule Health Report	*.pdf *.pdf *.doc or *.xls	3 days prior to meeting
3.9.5	3.1.6 3.3 3.4.2 3.8.4.1 3.8.4.2 3.8.4.3	50 Percent Conference Support -Gantt Chart (Most recent Revised Weekly IPS) -Critical Path Network (PDM) -Schedule Health Report -Machinery Reinstallation Plan -Valve Listing -Incomplete PCD Listing	*.pdf *.pdf *.doc or *.xls *.xls *.xls *.xls	3 days prior to meeting
3.9.6	3.1.6 3.3 3.4.2 3.8.5	75 Percent Conference Support -Gantt Chart (Most recent Revised Weekly IPS) -Critical Path Network (PDM) -Schedule Health Report -Underway test schedule	*.pdf *.pdf *.doc or *.xls *.xls	3 days prior to meeting

Table 3  
Initial IPS Schedule Submission Requirements

Firm Fixed Price Type Contract	Cost Plus Type Contract
The earlier of: 60-days after contract award or A-7	NLT A-30 Days (Surface Ships)
	NLT A-60 Days (CVNs and Submarines)

4. NOTES:

4.1 Definitions.

4.1.1 Critical Path Method: The critical path method is used to derive the critical activities—that is, activities that cannot be delayed without delaying the end date of the program. The amount of time an activity can slip before the program’s end date is affected is known as “total float.” Additionally, the critical path method is used for planning and executing complex, interdependent projects that identifies the Critical Path to each Key Event and Milestone using automated Network Analysis Tools. Unless the IPS represents the entire scope

of effort and the effort is correctly sequenced through network logic, the scheduling software will report an incorrect or invalid critical path. That is, the critical path will not represent the activities affecting the program finish date. With no accurate critical path, management cannot focus on the activities that will be detrimental to the program's key milestones and finish date if they slip.

4.1.2 Work Breakdown Structure: The WBS reflects how each Work Item is broken down into Work Activities in the IPS, representing a manageable unit of work to be accomplished at a specific period of time in relation to other Work Activities in the IPS to complete the Availability. Typical WBS might break a Work Item down into Work Activities to Remove a component, Repair the component, Install the Component, and Test the Component.

4.1.3 Industrial Testing: Conducted by using stages of testing for the progressive validation of the proper installation and performance of equipment and systems. Test Stages are identified in 009-67 of 2.1.

4.1.4 Integrated Production Schedule (IPS): A schedule used by the contractor as a means of planning, tracking, coordinating and de-conflicting work during the availability. It incorporates all work planned for accomplishment during the maintenance availability including; Alteration Installation Team (AIT), Government-Contracted Third Party Maintenance Providers, Ship's Force, Commercial Industrial Services (CIS), and Fleet Maintenance Activity (FMA) work. An IPS connects all the scheduled work of the government and the contractor in a network, or collection of logically linked sequences of activities. The sequences clearly show how related portions of work depend on one another, including the relationships between the government and contractors.

4.1.5 Work Activity: A portion of an individual Work Item, which is a logical subdivision of the Work Item, representing a manageable unit of work which must be accomplished at a specific period of time in relation to other Activities of the Job Order.

4.1.6 Duration: The total number of work periods (not including holidays or other nonworking periods) required to complete a scheduled Work Activity.

4.1.7 Key Event: Specific occurrences that could impact or delay the overall schedule, or prevent timely delivery of the vessel. Key Events are identified by the contract, the SUPERVISOR, or the contractor.

4.1.8 Milestone: A significant event identified by the Maintenance Team. Milestones are used as a scheduling aid and establish significant points where progress must be evaluated and confirmed. Accumulated failure to achieve Milestones on schedule may result in missed Key Events. Milestones may be identified by either the contractor or the SUPERVISOR.

4.1.9 Critical Path: That sequence of Work Activities which forms the work and test chain of the longest duration, and directly affects the completion of the availability. Factors that influence when a Work Activity is on the Critical Path include: time duration required for the Work Activity, space limitations, manpower available, and the predecessor/successor relationships between Work Activities. The Critical Path is determined by automated schedule

analysis and will include any sequential set of Work Activities forming the longest chain of events extending throughout the schedule and which has the least Total Float.

4.1.10 Controlling Work Items: Specifications in which include activities that are on the critical path of the IPS, which, by virtue of scope, material requirements, complexity, or other considerations, have the significant potential for impact on the scheduled project Key Events or completion of the availability.

4.1.11 Total Float: The total number of days that the Contractor can delay a Work Activity without affecting the project finish date. A path of Work Activities is established by predecessor and successor relationships.

4.1.12 Logic Relationship: Defines an interdependence between Work Activities. It is established by assigning predecessor and successor relationships to Work Activities using the functionality provided by project scheduling software. An individual Work Activity will frequently have more than one predecessor or more than one successor.

4.1.13 Network: A graphic display showing the planned sequence and interdependent relationship of Work Activities, Milestones, or Key Events within the Job Order.

4.1.14 Resource: Labor and non-labor demands required to complete a Work Activity. These may include personnel (trade skills), material, special tools, facilities, space, and equipment.

4.1.15 Baseline Start or Baseline Finish. The date identified in the IPS when the contractor plans to start or finish (respectively) the Work Activity. This may be established by a controlled schedule baseline (preferred method) or by manual entry into the scheduling software according to contractor policy/practice.

4.1.16 Planned progress percent. Baseline progress of work to be completed based on planned start and planned finish dates.

4.1.17 Actual Progress percent. Degree of completion based on the Work Activity's work scope and degree of accomplishment of production labor.

4.1.18 Early Start: The earliest point in time that a Work Activity may start based on the IPS network logic and any other schedule constraints. Early start dates may change as the availability progresses.

4.1.19 Early Finish: The earliest point in time that a Work Activity may be completed based on the IPS network logic and any schedule constraints. Early finish dates may change as the availability progresses.

4.1.20 Late Start: The latest point in time that a Work Activity may begin without delaying the applicable Milestone or Key Event based on the IPS network logic.

4.1.21 Late Finish: The latest point in time that a Work Activity may be completed without delaying the applicable Milestone or Key Event based on the IPS network logic.

4.1.22 Integration: The incorporation of all work (including testing and availability work certification) for all organizations involved in an availability.

4.1.23 Precedence Diagram Method (PDM): Used in Critical Path Method Project Management for building a project schedule network diagram using lines and nodes to show the logical relationship between schedule activities.

4.1.24 Gantt Chart: A graphic display of schedule-related information. Typically, schedule Work Activities or work breakdown structure components are listed down the left side of the chart, dates are shown across the top, and Work Activity durations are shown as date-placed horizontal bars.

4.1.25 Negative Float: The amount of time by which the early start or finish dates of a Work Activity exceeds its late start or ending dates. The quantity of float then indicates the amount of time that must be recovered in order to achieve an imposed date.

4.1.26 Schedule of Record: The official IPS at the start of the availability (A-0 day) that includes refined sequencing and completeness as a result of completed subcontracting actions, incorporation of additional Government Furnished Information (GFI), or any contract modifications increasing the scope of work between contract/delivery Order award and availability start.

4.1.27 Un-Exercised Level of Effort: LOE which has not been settled and placed on contract.

4.1.28 Hard Constraint: A Mandatory Start or Finish date imposed on an activity, i.e. the activity becomes fixed to that date. When expressed as the activity Must Start On (MSO) or Must Finish On (MFO) the given date. Hard Constraints prevent their associated activity from being logic-driven.

4.1.29 Schedule Health Report: A report inferring the reliability of the IPS in accurately predicting availability progression based on correct logic relationships, adequate work breakdown structure, and the completion of work. Schedule Health report elements include:

4.1.29.1 Activities with missing logic. Denotes incomplete activities without a predecessor or successor relationship to another activity. Threshold value is 2 activities of the total incomplete work activities in the IPS. Does not include Summary Activities.

4.1.29.2 Finish-to-Start Percentage. Denotes the preference for use of Finish-to-Start logic relationships between incomplete work activities in the IPS. Calculated by dividing the total number of Finish-to-Start logic links by the total number of all logic link types in the IPS. There is no threshold value; however, a Finish-to-Start percentage below 90 percent may require explanation by the contractor for other relationship types and their application.

4.1.29.3 Activities with negative float. Denotes the accumulation of incomplete activities projected to finish later than required to maintain the downstream schedule. Threshold value is 5 percent. Does not include Summary Activities.

4.1.29.4 Activities with high (>60 days) duration. Denotes incomplete activities that may not be distributed into an effective Work Breakdown Structure. Threshold value is 5% of the total incomplete work activities in the IPS. Does not include Summary Activities or administrative and support activities planned for the duration of the availability.

4.1.29.5 Progressing Percentage. Denotes success in meeting scheduled activity completion for the 25, 50 and 75 percent point of the availability. Calculated by dividing the number of activities actually completed in the period prior to the data date of the analysis by the number of activities required to complete in the same time period according to the planned schedule finish dates. Does not include Summary Activities, or GFI regarding work accomplished by AIT, Government-Contracted Third Party Maintenance Provider, S/F, CIS, and FMA. There is no threshold value, however, throughput below 80 percent must be evaluated to understand causal factors and potential impact to on-time availability completion.

4.1.30 Lags and Leads. Lags and Leads are scheduling functions used to represent a gap (Lag) or overlap (Lead) between activities. The use of Lags and Leads must be controlled to ensure they support an accurate and logical work flow. Improper and overuse of Lags and Leads can have a detrimental effect on a logic driven schedule and adversely affect float and the Critical Path. Typical examples where their use may be warranted include: insertion of time delay to represent report cycle time, staggering unrelated work item start dates, or drive work based on material receipt projection.

4.1.30.1 Lag: The delayed start of a successor activity and represents time that must pass before the second activity can begin.

4.1.30.2 Lead: The accelerated start of a successor activity where there is a finish to start relationship. The second activity can begin and be conducted in parallel with the first activity.

4.1.31 Schedule Model Review. An LMA-led event to review the IPS (in its current state) and thorough discussion of any predicted challenges, constraints, schedule efficiencies, etc will be conducted in accordance with contractual requirements. The contractor will discuss the schedule in sufficient detail to support understanding of time and space constraints, critical and controlling path work, and items requiring integration. CNRMCINST 4701.1 Schedule Model Review (SMR), provides policy and guidance for the administration, preparation and execution of the Schedule Model Review (SMR) meeting.

4.1.32 Full Time Equivalent (FTE) – A normalized representation of full-time workers based on the number of hours spent/scheduled during a finite period of time. An FTE unit assumes an 8-hour work day and a 5-day work week (Monday-Friday) except when accounting for holidays. For example, if the hours spent or scheduled during a week with one holiday was 160 hours, then the FTE value representing that week would be equal to 5 FTE (160 hours divided by 8-hour days divided by 4 work days equals 5 FTE).

4.1.33 CNRMC Instruction 4711.1 OPEN AND INSPECT REPORTS; POLICY provides guidance for the request and approval process for additional O&I milestones.

4.2 The SUPERVISOR will provide, or direct provision, of the AIT, Government-Contracted Third Party Maintenance Providers, S/F, CIS, and FMA availability data required for schedule integration in 3.1.1, 3.1.2.3, and progress/de-confliction in 3.6.

4.3 When invoked, the following Standard Items interface with this Standard Item: 009-67, and 009-81.

4.4 The following codes are provided as designators for Key Events within the IPS as directed in 3.1.7.

Code	Description / Meaning
AC	Availability Complete
C5ILO (C5I)	Command, Control, Communications, Computer, Combat Systems and Intelligence Light-Off
DT	Dock Trials
FC	Fast Cruise
UD	Undock/Flood Dock
PCD	Engineering Plant Production Completion Date (Propulsion/Aux)
WC	Work Complete
ST	Sea Trials

4.5 The following codes are provided as designators for specific ship systems when applied to Work Activities in the IPS as directed in 3.1.7. More than one designator may be used for a Work Activity. This list is not all-inclusive.

Code	System
ACE	Aircraft Elevator
ACP	Air Conditioning Plant
AG	Arresting Gear
ANT	Antenna
AUX	Auxiliary Steam
BIL	Bilges
CAT	Catapults
CHT	Collecting, Holding and Transfer
CHW	Chilled Water
COM	Communications
CNDS	Condensate
CS	Combat Systems
CMWD	Countermeasures Wash Down
DECK	Any Decking Work
DC	Damage Control
ENG	Engineering
MNFD	Main Feed
FDK	Flight Deck
FM	Fire Main
FO	Fuel Oil
HAB	Habitability

HDK	Hangar Deck
HPA	High Pressure Air
HULL	Hull
IC	Internal Communication
JP5	JP-5 Tanks/System
LAG	Lagging and Insulation
LC	Load Center
LO	Lube Oil
MAG	Magazine
MS	Main Steam
NSK	Non-Skid
PROP	Propulsion System, including Controllable Pitch Propeller
PW	Potable Water
SCAF	Scaffolding Required
SS	Service Steam
STRG	Steering System
STRL	Structural, General
SW	Sea Water
TIS	Temporary Industrial Systems
VEN	Vents/Ventilation
VPC	Vertical Package Conveyor
WH	Water Heaters
WEL	Weapons Elevator
WPNS	Weapons
WW	Waste Water

4.6 The following standard convention is used for identifying locations when applied to Work Activities in the IPS as directed in 3.1.7. The use of general terminology, such as “throughout ship”, as a means of documenting location must be minimized.

- Space/Compartment Number (i.e. 03-130-2-L, 6-81-0-E, etc.)
- Flight and Hangar Deck Locations: deck-frame-P or S (e.g. 04-190-S or 1-190-P)
- Weather Decks: closest deck-frame-P or S (e.g. 03-140-P-WEA)
- Span of Frames: deck-frame span-P or S (e.g. for flight deck frames 55 to 100 starboard side use 04-55/100-S)
- Masts: Use mast name (e.g. Main Mast, etc.)







Attachment A

**Production Progress (not inclusive of material):**

	Current Week
Planned Progress	
Actual Progress	

**Pending RCC Impact Summary:**

Growth/New Work Hours	
Descope Hours	

Attachment A

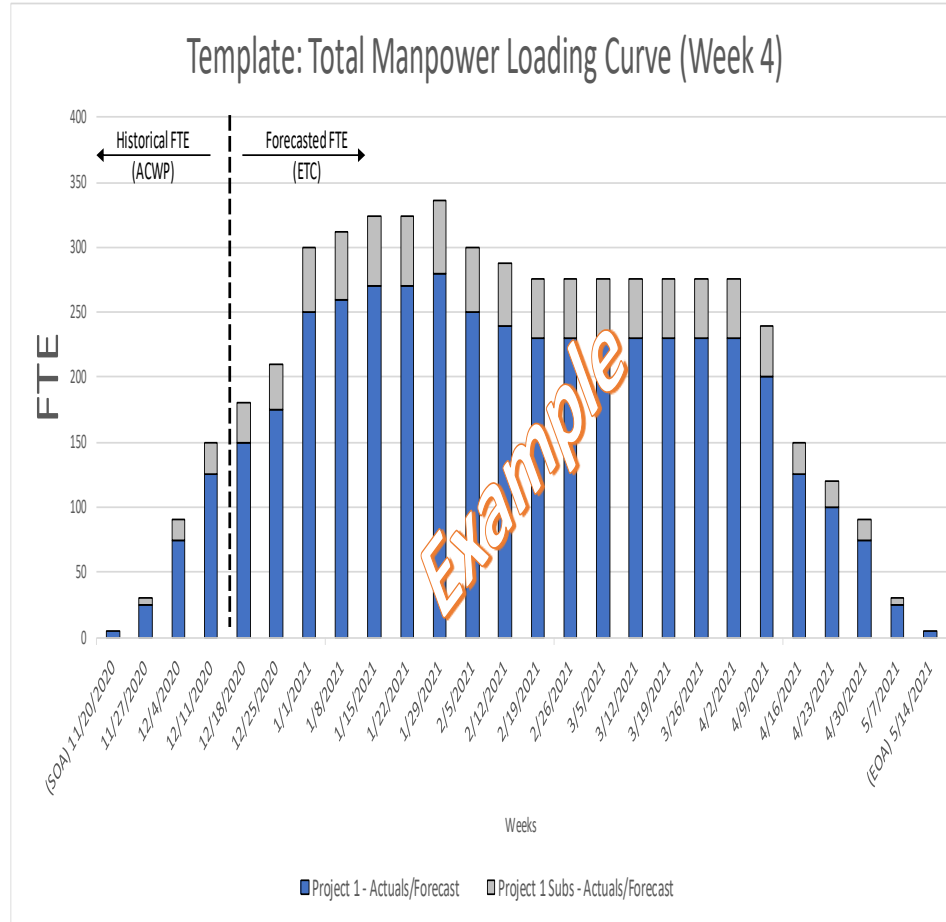

	(SOA) 11/20/20	11/27/2020	12/4/2020	12/11/2020	12/18/2020	12/25/2020	1/1/2021	1/8/2021	1/15/2021	1/22/2021	1/29/2021	2/5/2021	2/12/2021	2/19/2021	2/26/2021	3/5/2021	3/12/2021	3/19/2021	3/26/2021	4/2/2021	4/9/2021	4/16/2021	4/23/2021	4/30/2021	5/7/2021	(EOA) 5/14/2021
Project 1 - Actuals/Forecast	5	25	75	125	150	175	250	260	270	270	280	250	240	230	230	230	230	230	230	230	200	125	100	75	25	5
Project 1 Subs - Actuals/Forecast		5	15	25	30	35	50	52	54	54	56	50	48	46	46	46	46	46	46	46	40	25	20	15	5	0

\*Template contains notional data. To be revised for contractual submission.

Attachment A

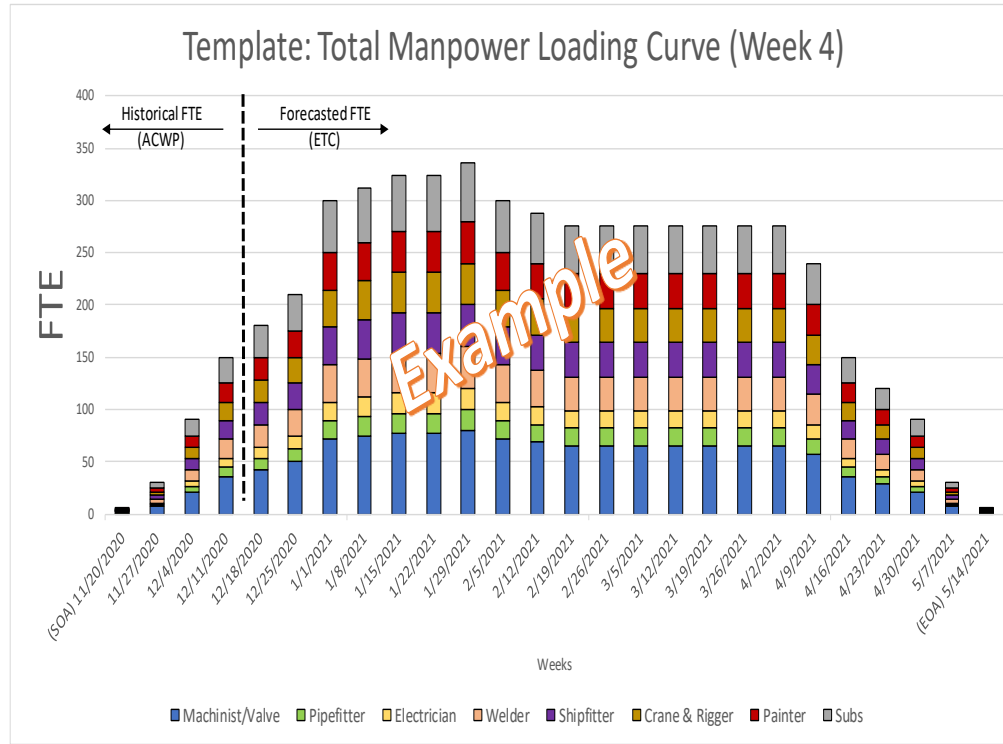

	(SOA) 11/20/2020	11/27/2020	12/4/2020	12/11/2020	12/18/2020	12/25/2020	1/1/2021	1/8/2021	1/15/2021	1/22/2021	1/29/2021	2/5/2021	2/12/2021	2/19/2021	2/26/2021	3/5/2021	3/12/2021	3/19/2021	3/26/2021	4/2/2021	4/9/2021	4/16/2021	4/23/2021	4/30/2021	5/7/2021	(EOA) 5/14/2021	
Machinist/Valve	1	7	21	36	43	50	71	74	77	77	80	71	69	66	66	66	66	66	66	66	66	66	66	66	66	66	66
Pipefitter	0	2	5	9	11	13	18	19	19	19	20	18	17	16	16	16	16	16	16	16	16	16	16	16	16	16	16
Electrician	0	2	5	9	11	13	18	19	19	19	20	18	17	16	16	16	16	16	16	16	16	16	16	16	16	16	16
Welder	1	4	11	18	21	25	36	37	39	39	40	36	34	33	33	33	33	33	33	33	33	33	33	33	33	33	33
Shipfitter	1	4	11	18	21	25	36	37	39	39	40	36	34	33	33	33	33	33	33	33	33	33	33	33	33	33	33
Crane & Rigger	1	4	11	18	21	25	36	37	39	39	40	36	34	33	33	33	33	33	33	33	33	33	33	33	33	33	33
Painter	1	4	11	18	21	25	36	37	39	39	40	36	34	33	33	33	33	33	33	33	33	33	33	33	33	33	33
Subs	0	5	15	25	30	35	50	52	54	54	56	50	48	46	46	46	46	46	46	46	46	46	46	46	46	46	46

\*Template contains notional data. To be revised for contractual submission.

NAVSEA  
STANDARD ITEM

FY-24

ITEM NO: 009-61  
DATE: 25 OCT 2022  
CATEGORY: I

1. SCOPE:

1.1 Title: Shipboard Use of Fluorocarbons; control

2. REFERENCES:

2.1 Standard Items

2.2 29 CFR Part 1915, Occupational Safety and Health Standards for Shipyard Employment

2.3 NFPA Standard 306, Standard for the Control of Gas Hazards on Vessels

2.4 40 CFR Part 82, Protection of Stratospheric Ozone, Subpart F

3. REQUIREMENTS:

3.1 Accomplish work associated with the use of fluorocarbons aboard ship in accordance with this item.

3.2 Maintain at the work site a copy of the credentials of the Competent/Qualified Person who will monitor atmosphere, inspect and certify spaces are safe to enter, and who will supervise all activities.

3.2.1 A Qualified Person is defined as a National Fire Protection Association Certified Marine Chemist, an Industrial Hygienist, or a Competent Person as defined in 2.2 and trained in accordance with 009-07 of 2.1. These Qualified Persons must be capable of specifying the necessary protection and precautions to be taken during fluorocarbon operations, as designated in 2.2 and 2.3.

3.3 Maintain a copy of a fluorocarbon control plan at the work site. The plan must include the following information and must be provided to the SUPERVISOR upon request:

3.3.1 Identification of hose/piping routes and steps to be taken to protect hoses along those routes

3.3.2 Type and location of warning signs

- 3.3.3 Type and location of portable ventilation required
- 3.3.4 Means of communication to be utilized
- 3.3.5 Type of hoses and material compatibility to fluorocarbons
- 3.3.6 Type of emergency breathing devices that are immediately accessible
- 3.3.7 Type and location of portable oxygen and halide monitoring detectors/alarms
- 3.3.8 Emergency evacuation and rescue procedures
- 3.3.9 Open flame and hot work controls
- 3.3.10 Results of preliminary tests, ensuring system integrity and absence of leakage
- 3.3.11 Provisions for periodic inspections that include adjacent spaces to ensure work area containment and work practices are effective

3.4 Submit written notification to the SUPERVISOR and the Commanding Officer's designated representative at least 4 hours, but not more than 24 hours prior to commencement, each time fluorocarbons are utilized aboard ship for any purpose. Identify the time, location, and purpose of each evolution. Notify the SUPERVISOR and designated ship's representative immediately prior to the actual start and upon completion of each evolution.

3.4.1 Deliver notification of work planned Tuesday through Friday to the Commanding Officer's designated representative at least 30 minutes and not more than 24 hours preceding start of work.

3.4.2 Deliver notification of work planned over a weekend or Monday following that weekend to the Commanding Officer's designated representative no later than 0900 on the Friday immediately preceding that weekend.

(I) "INSPECT FLUOROCARBON EQUIPMENT"

3.5 A certified technician must, as required by 2.3, pressure test the fluorocarbon charging and flushing handling equipment, i.e., hoses, piping, valves, fittings, and manifolds, using dry nitrogen with trace amounts of HFC-134a compound at 150 percent of charging equipment working pressure within 30 days prior to use aboard ship. Hold test pressure for 15 minutes. Allowable leakage: None.

3.5.1 Attach a solid metal tag with the following to each piece of equipment passing test:

3.5.1.1 Name and address of testing facility

3.5.1.2 Description of equipment

3.5.1.3 Date of test

3.5.1.4 Test pressure

(I)(G) "INSPECT WORK SITE AND PROCESS PRIOR TO FLUOROCARBON OPERATIONS"

3.6 Inspect work site to ensure the following prior to fluorocarbon operations:

3.6.1 Provide ventilation to maintain oxygen content above 19.5 percent and not greater than 22.0 percent by volume in spaces where fluorocarbon compounds are in use.

3.6.2 Establish and maintain telephone communication between the pumping station and the space involved when the fluorocarbon compound is being transferred by hose or pipe.

3.6.3 Ensure that all personnel in a space where fluorocarbon operations are being carried out have an emergency escape breathing device (EEBD) in their possession or in the immediate area so that they can quickly don the units in case of a leak.

3.6.3.1 Each person must have received instruction and practice in the use of the particular EEBD to be used, prior to entering each space where fluorocarbon operations are being carried out.

3.6.4 Suspend hot work in spaces prior to hook-up, test, and disconnect operations in which fluorocarbon compounds are exposed to the atmosphere.

3.6.4.1 Hot work is permitted in spaces traversed by lines carrying fluorocarbon compounds provided the lines are clearly tagged and no hot work is attempted within 3 feet of a tagged line.

3.6.5 Provide a halide monitor with alarm or equivalent instrument to continuously monitor the atmosphere in spaces where fluorocarbon compounds are used. If the concentration of fluorocarbon compound in the space exceeds the Threshold Limit Value (TLV) for the fluorocarbon compound (where the instrument is set to alarm), clear the space of personnel, notify Quarterdeck Watch immediately and the SUPERVISOR as soon as practical but not more than 30 minutes after the instrument alarms.

3.6.6 Post a caution sign in the area and at each entrance to the area.

3.6.6.1 The sign must read: CAUTION: No open flames. Do not enter without testing the air for fluorocarbons.



3.6.6.2 The sign letters must be at least one-inch high.

3.6.7 Provide a minimum of 2 people trained and familiar with the operation while a fluorocarbon compound is being used in quantities exceeding 10 pounds.

3.7 Accomplish preliminary pressure tests of charging/flushing equipment after connecting aboard ship each time equipment is used. Pressure must equal 100 percent of charging/flushing equipment working pressure. Hold test pressure for 15 minutes. Allowable leakage: None.

3.7.1 Ensure charging equipment is isolated from equipment to be charged prior to test.

3.8 A certified technician must, as required by 2.4, ensure that fluorocarbon gases are not vented to the interior of the ship or to the atmosphere when pressure is released from the system by utilizing recovery/recycling equipment tested and certified by an Environmental Protection Agency (EPA) approved laboratory or organization.

3.8.1 All CFCs, HCFCs, HFCs, and Halons must be recovered for either recycling back into the same system/piece of equipment from which the material was recovered, collected for turn-in to the DoD ODS Reserve (CFC-11, CFC-12, CFC-114, R-500, R-502, HCFC-22, Halon 1211, and Halon 1301), or collected for eventual reclamation by an EPA-certified refrigerant reclaimer (for refrigerants not included in the ODS Reserve).

#### 4. NOTES:

4.1 Following are examples of commonly used fluorocarbon compounds:

Trichlorofluoromethane, Freon 11, R-11 (CFC-11)  
Dichlorodifluoromethane, Freon 12, R-12 (CFC-12)  
Chlorotrifluoromethane, R-13 (also component of R-503) (CFC-13)  
Pentachlorofluoroethane (CFC-111)  
Tetrachlorodifluoroethane (CFC-112)1,1,2 Trichloro-1,2,2  
Trifluoroethane, Freon 113, Freon TF, Freon PCA,  
Genetron 113 (CFC-113)1,2  
Dichlorotetrafluoroethane, R-114, Freon 114 (CFC-114)  
Chloropentafluoroethane, R-115 (also component of R-502) (CFC-115)  
Heptachlorofluoropropane (CFC-211)  
Hexachlorodifluoropropane (CFC-212)  
Pentachlorotrifluoropropane (CFC-213)  
Tetrachlorotetrafluoropropane (CFC-214)  
Trichloropentafluoropropane (CFC-215)  
Dichlorohexafluoropropane (CFC-216)  
Chloroheptafluoropropane (CFC-217)  
Tetrafluoroethane (HFC-134a)

Chlorodifluoromethane, Freon 22, R-22 (HCFC-22)  
Hexafluoropropane, R-236fa (HFC-236fa)  
R-404A, A blend of HFC-125, HFC-143a and HFC-134a  
R-407A, A blend of HFC-32, HFC-125, and HFC-134a

4.2 EEBD equipment for Government representatives will be provided by the Government.

4.3 ODS material must be procured as Government Furnished Material (GFM) from the DOD ODS Reserve. Notify the SUPERVISOR at least 14 days prior to anticipated usage.

4.4 The following definitions are delineated by Navy policy:

4.4.1 Recover - To remove refrigerant in any condition from a system and store it in an external container without necessarily testing or processing it in any way.

4.4.2 Recycle - To reduce contaminants in used refrigerant by oil separation and single or multiple passes through devices such as replaceable core filter dryers that reduce moisture, acidity and particulate matter. The term usually applies to procedures implemented at the field job site or at a local service shop.

4.4.3 Reclaim - To reprocess refrigerant to new product specifications by means that may include distillation. Chemical analysis of the refrigerant is required to determine that appropriate product specifications are met. This usually implies the use of processes or procedures that are available only at refrigerant reprocessing or manufacturing facilities.

NAVSEA  
STANDARD ITEM

FY-24

ITEM NO: 009-62  
DATE: 25 OCT 2022  
CATEGORY: II

1. SCOPE:

1.1 Title: Boiler Handhole, Manhole Seat and Plate; inspect

2. REFERENCES:

2.1 S9221-C1-GTP-010, Main Propulsion Boilers; Repair and Overhaul

2.2 803-841216, Handhole Plates and Arch Bars for Boilers

3. REQUIREMENTS:

3.1 Remove each handhole and manhole plate from each header and drum of boiler. Each plate must be identified and tagged as to respective boiler.

3.2 Wire brush clean to bare metal each handhole, manhole plate, stud, strongback, and fastener. Wire brush clean to bare metal each handhole and manhole gasket seating surface using a power driven wire cup brush. Ensure complete removal of rust and gasket material.

3.2.1 Wire brush clean to bare metal external surfaces in way of "B" and "C" measurement contact areas using a power-driven wire wheel or needle gun.

3.3 Visually inspect each gasket seating surface of handhole and manhole plates and the drum and header for erosion, corrosion, gouges, steam cuts, crack indications, excessive pitting, grooves, and any irregularities that may cause poor or leaky joints. Inspect external surfaces of headers in way of "B" and "C" measurement areas for erosion and corrosion. Inspect studs and nuts for deterioration and damaged and stripped threads.

3.3.1 Visually inspect, measure, and record the following handhole and manhole gasket seating surface criteria in accordance with Paragraph 5-8.2 of 2.1 and Attachment A.

3.3.1.1 Seat taper: Use template of flat stock and feeler gage to measure maximum taper around periphery of handhole and manhole seats.

3.3.1.2 Minimum wall thickness: Measure header wall thickness using a point micrometer at each side of the header cross sectional minor axis.

3.3.1.3 Minimum seat thickness: Measure header seat thickness with a flat-faced micrometer at the 4 points of the header cross sectional major and minor axis.

3.3.1.4 Handhole Plate Overlap: Measure maximum gap clearance between shoulder of the handhole plate and handhole with handhole plate located in the most extreme misaligned position. Subtract the measurement from the plate seat width to establish the amount of plate overlap. Handhole plates used for measurements must conform to 2.2.

3.3.1.5 Manhole Plate Clearance: Measure clearance between shoulder of manhole plate and manhole at 8, 45-degree increments, with the manhole plate accurately centered.

3.4 Submit one legible copy, in approved transferrable media, of a report listing results of the requirements of 3.3 to the SUPERVISOR. Report must list each handhole and manhole seat which failed to meet the minimum allowable values listed in Appendices 5D, 5E, and 6C of 2.1.

3.5 Install each handhole and manhole plate, using new gaskets conforming to MIL-G-15342 and applicable boiler technical manual.

4. NOTES:

4.1 Equipment technical manual will be listed in the invoking Work Item.

ATTACHMENT A

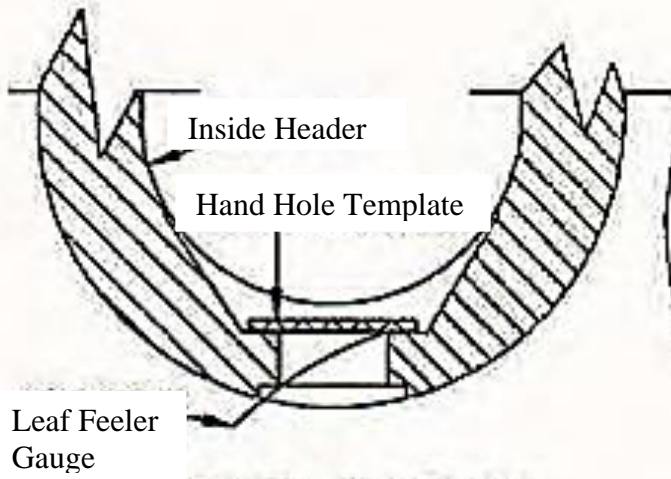

SEAT TAPER

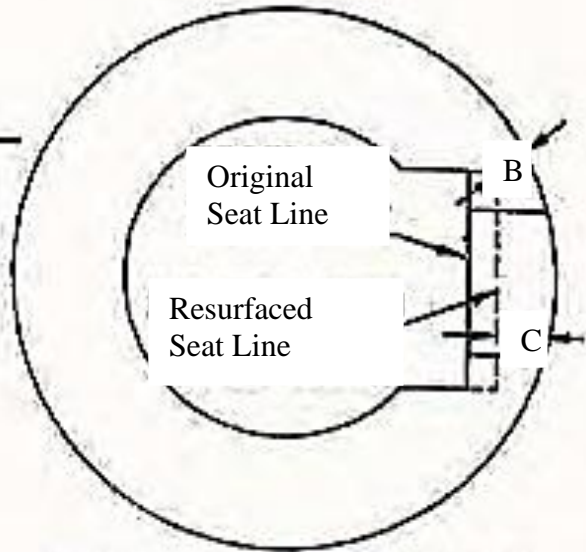

MIN. WALL THICKNESS-DIM. B  
MIN. SEAT THICKNESS\_DIM. C

MIN. WALL and SEAT

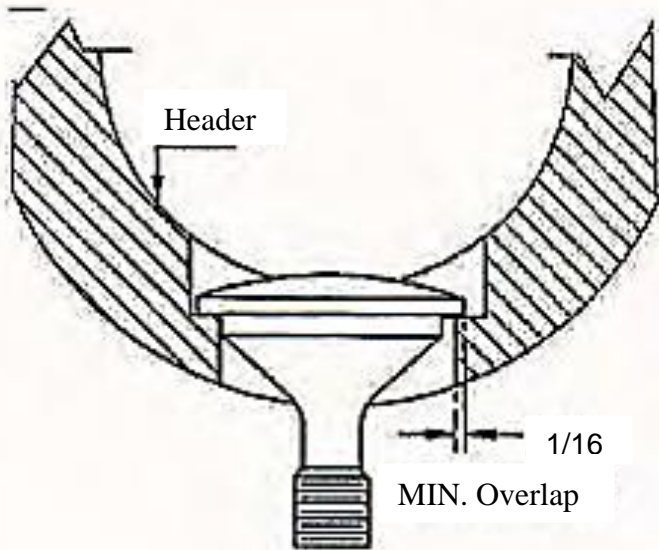

OVERLAP

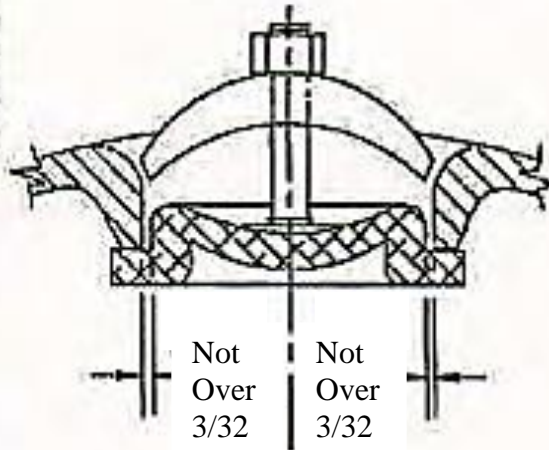

MANHOLE  
CLEARANCE

NAVSEA  
STANDARD ITEM

FY-24

ITEM NO: 009-63  
DATE: 25 OCT 2022  
CATEGORY: II

1. SCOPE:

1.1 Title: Lubricating Oil and Hydraulic Fluid; analyze

2. REFERENCES:

2.1 S9086-H7-STM-010/CH-262, Lubricating Oils, Greases, Specialty Lubricants, and Lubrication Systems

2.2 S9086-S4-STM-010/CH-556, Hydraulic Equipment (Power Transmission and Control)

3. REQUIREMENTS:

3.1 Provide samples (lubricant oil or hydraulic fluids) to a certified laboratory as listed in Table 262-4-2 of 2.1. Navy Oil Analysis Program (NOAP) Laboratories Capabilities or a certified commercial laboratory (minimum ISO 9000 or ISO 17025 registered). Minimum sample label requirements are listed in 262-4.4.1.1 NOAP Sample Label of 2.1.

3.2 Accomplish tests of each sample in accordance with the specified test methods listed in Appendix B NOAP Equipment Wear Metal Limits, Appendix C NOAP Physical Properties Limits, and Appendix E DRS Physical Property and Wear Metal Limits of 2.1, as applicable, and Table 556-8-1 Allowable Use Limits of Hydraulic Fluids of 2.2. All flushes at a minimum, require particulate and water testing. If the system has been exposed to any fluid besides the oil for the system, foaming and wear metal testing are also required. Additional testing based on specific system is listed in Appendix B NOAP Equipment Wear Metal Limits, Appendix C NOAP Physical Properties Limits and Appendix E DRS Physical Property and Wear Metal Limits of 2.1.

3.2.1 Test selections must be based on the sample type and service.

3.2.2 Fluid property test name, applicable ASTM Test Method and associated NSTM reference used to perform sample testing are listed in TABLE 1 below.

Table 1. Fluid property, applicable ASTM Test Method and associated NSTM reference for lubricating oil and hydraulic fluid sample testing.

FLUID PROPERTY	ASTM TEST METHOD	NSTM REFERENCE
----------------	------------------	----------------

Viscosity at 40°C	ASTM D445	NSTM 262-4.5.1
Viscosity at 100°C	ASTM D445	NSTM 262-4.5.2
Acid Number	ASTM D664 or ASTM D974	NSTM 262-4.5.3
Water by Karl Fischer	ASTM D6304	NSTM 262-4.5.5
Particle Count		NSTM 262-4.5.6
Total Base Number	ASTM D4739 or ASTM D2896	NSTM 262-4.5.7
Fuel Dilution	ASTM D7593	NSTM 262-4.5.8
Flashpoint	ASTM D93 or ASTM D6450	NSTM 262-4.5.8.2
Spectrometric Analysis	ASTM D6595 or ASTM D5185	NSTM 262-4.5.11.2

3.3 Analyze each sample for water contamination by utilizing an automatic coulometric titrator by Karl Fischer in accordance with ASTM D-6304 as described in 262-4.5.5 Water by Karl Fischer Method of 2.1.

3.3.1 Determine if water contamination is fresh or salt water based on high sodium levels. Seawater contamination results in sodium levels at or above approximately 5ppm of sodium present when water results are 0.05% and approximately 20 ppm of sodium present when water results are 0.20%.

3.3.2 The sensitivity and reliability of the equipment used for the test must be in accordance with ASTM D-6595 and ASTM D-6304, respectively.

3.4 Analyze each sample for metal content by utilizing a spectrographic analysis in accordance with ASTM D-6595 as described in 262-4.5.11.2 Spectrometric Wear Metal Analysis of 2.1.

3.4.1 Record and report the concentration of the following elements in ppm with the indicated degree of accuracy:

IRON	COPPER	TIN	MAGNESIUM	LEAD
ALUMINUM	SILVER	CHROMIUM	NICKEL	SILICON
SODIUM				

3.4.1.1 The sensitivity and reliability of the equipment used for the test must be in accordance with ASTM D-6595.

3.5 Accomplish specific gravity test for each MIL-H-19457 hydraulic fluid sample and determine hydrocarbon oil content in accordance with Table 556-8-1 Allowable Use Limits of Hydraulic Fluids of 2.2.

3.6 Submit one legible copy, in hard copy or approved transferrable media, of a report listing completed test results of 3.2 through 3.5 for each sample to the SUPERVISOR. (See NOTE 4.1)

3.6.1 Reports must be submitted within 2 days after the qualified chemical laboratory (as listed in Table 262-4-2 NOAP Laboratories with Capabilities and Contact Information of 2.1) receives each sample.

3.6.2 Reports must include recommendations for continued use, disposal, or re-sampling of each tested oil or fluid sample. If a commercial lab is used, results should be submitted to NAVSEA via NSWCPD\_Lubricants@navy.mil for further guidance.

3.7 Use Appendix B NOAP Equipment Wear Metal Limits, Appendix C NOAP Physical Properties Limits and Appendix E DRS Physical Property and Wear Metal Limits of 2.1, and Table 556-8-1 Allowable Use Limits of Hydraulic Fluids of 2.2 for guidance for test accept and reject criteria for each in-service sample.

3.7.1 For foaming results interpretation forward results to NAVSEA via NSWCPD\_Lubricants@navy.mil for further guidance.

3.8 Submit one legible copy, in hard copy or approved transferrable media, of original manufacturer's certificate of compliance and material conformance test data in Appendix B NOAP Equipment Wear Metal Limits, Appendix C NOAP Physical Properties Limits and Appendix E DRS Physical Property and Wear Metal Limits of 2.1, as applicable, and Table 556-8-1 Allowable Use Limits of Hydraulic Fluids of 2.2, 7 days prior to use of new fluids and oils.

#### 4. NOTES:

4.1 For boats and craft 65 feet or less in length modify sections 3.1, 3.5, 3.6 and 3.7 to include Original Equipment Manufacturer (OEM) laboratories, procedures, specifications and test results.



Attachment A

LUBERCATING

ASTM TEST METHOD	MIL-PRF-17672 MS-2075-TH MS-2110-TH MS-2135-TH	MIL-PRF-17331 MS-2190-TEP	MIL-PRF-9000 9250	MIL-PRF-2104 15W/40	MIL-PRF-23699	VV-L-825
FUEL DILUTION VIA FLASH POINT ASTM D93			X	X		
PERCENT WATER ASTM D6304	X	X		X		X
VISCOSITY ASTM D445		X	X	X	X	
ACID NO. ASTM D974	X	X		X	X	X
TOTAL BASE NO. ASTM D2896			X	X		
SPECTROGRAPHIC ANALYSIS ASTM D6595	X	X	X	X	X	X

X - IDENTIFIES EACH TEST REQUIRED FOR EACH FLUID TYPE

Attachment B

HYDRALIC FLUIDS

ASTM TEST METHOD	MIL-DTL-17111	MIL-H-19457	MIL-PRF-2104 MIL-PRF-17672 MS-2075-TH MS-2110-TH MS-2135-TH	MIL-PRF-17331 MS-2190-TEP	MIL-H-22072
FLASH POINT ASTM D92	X				X
PERCENT WATER ASTM D95					X
PERCENT WATER ASTM D6304	X	X	X	X	
VISCOSITY ASTM D445	X		X	X	
ACID NO. ASTM D974	X	X	X	X	
PARTICLE COUNT NAS/SAE 4059 (Automatic Particle Count Method)	X	X	X	X	X

X - IDENTIFIES EACH TEST REQUIRED FOR EACH FLUID TYPE

NAVSEA  
STANDARD ITEM

FY-24

ITEM NO: 009-65  
DATE: 25 OCT 2022  
CATEGORY: II

1. SCOPE:

1.1 Title: Polychlorinated Biphenyls (PCBs); control

2. REFERENCES:

2.1 40 CFR Part 761, Polychlorinated Biphenyls (PCBs) Manufacturing, Processing, Distribution in Commerce, and Use Prohibitions

2.2 Toxic Substances Control Act (TSCA)

3. REQUIREMENTS:

3.1 Verify equipment identified as containing PCBs for leaks, deterioration, and corrosion prior to opening, removing, or installing equipment.

3.1.1 Submit one legible copy, in approved transferrable media, of a report listing results of the inspection conducted in 3.1 to the SUPERVISOR if a leak, deterioration, or corrosion is found.

3.2 Consider wool felt to contain PCBs and chromium.

3.2.1 Submit one legible copy, in approved transferrable media, of a report verifying wool felt (gasket or damping material), location, and approximate quantity to the SUPERVISOR.

3.3 Provide a copy of a control, method of removal, and disposal plan in accordance with 2.1 and/or 2.2 to the SUPERVISOR.

4. NOTES:

4.1 None.

NAVSEA  
STANDARD ITEM

FY-24

ITEM NO: 009-67  
DATE: 25 OCT 2022  
CATEGORY: I

1. SCOPE:

1.1 Title: Integrated Total Ship Testing; manage

2. REFERENCES:

2.1 Standard Items

2.2 S9AA0-AB-GOS-010, General Specifications for Overhaul of Surface Ships (GSO)

2.3 S9095-AD-TRQ-010/TSTP, Total Ship Test Program Manual

2.4 MIL-STD-2106 (SH), Development of Shipboard Industrial Test Procedures

2.5 Joint Fleet Maintenance Manual (JFMM)

3. REQUIREMENTS:

3.1 Develop an Integrated Total Ship Test Plan (ITSTP), using contracted work package and available GFI.

3.1.1 Prepare and manage a Comprehensive Test Plan (CTP) in accordance with Section 092c of 2.2; using 009-04 and 009-60 of 2.1, and 2.3 for guidance.

3.1.1.1 Define and document the responsibility, lines of authority, and interrelation of personnel who manage, assist, perform, or verify work.

3.1.1.2 Include provisions for completion of total ship testing through Stage 6 in accordance with section 092c of 2.2 and 2.3 prior to dock trials using data from 009-60 of 2.1 (See 4.1 for examples).

3.1.1.3 Submit one legible copy, in approved transferrable media, of the CTP to the SUPERVISOR no later than 15 days prior to availability start date.

3.1.2 Include a Test Schedule (TS). (See 4.3 and 4.4)

3.1.3 Include a list of special purpose test equipment and software, with required dates and responsible provider (See 4.6).

3.1.3.1 Provide the requirements for special purpose test equipment, weapon test shapes, dummy loads, and test weights, to accomplish total ship testing. Identify known and anticipated deficiencies in required type, quantity, calibration, or availability to support the production or test schedule.

3.1.4 Include organizational responsibility for equipment operation, start up, and accomplishment of testing, including manning requirements.

3.1.5 Include a list of SUPERVISOR, contractor, Alteration Installation Team (AIT), and Ship's Force key test team personnel, with test sign-off authority.

3.1.6 Include administrative procedures for submittal of Test Problem Reports (TPRs), Test Failure Reports (TFRs), and test status.

3.1.7 Submit one legible copy, in approved transferrable media, of the ITSTP to the SUPERVISOR no later than the start of the availability.

3.2 Accomplish Test Procedures (TP) for all Stage 3 through 7 Tests as specified in the work item.

3.2.1 Reuse existing Government approved test procedures when available. Test and Evaluation Automated Management Information System (TEAMIS), the government's Non-Nuclear Surface Ship Test procedure management program, must be the primary source for approved Government test procedures per 2.3.

3.2.1.1 Modify existing test procedures to limit scope to match repair and/or update to match current equipment or revised specifications for the test requirements using 2.4 for guidance.

3.2.2 Develop new test procedures when reusable product is not available for the required tests using 2.4 for guidance.

3.2.2.1 Cover sheet must designate ship or ship class and system or component, and provide completed review signatures.

3.2.3 Submit one legible copy, in approved transferrable media, of each test procedure to the SUPERVISOR for review and approval. Submission must be no later than 14 days prior to start of the required test or as otherwise designated by the SUPERVISOR.

3.2.4 Submit one legible copy, in approved transferrable media, of each updated or changed test procedure to the SUPERVISOR at least 3 days prior to implementation.

3.2.5 Make pen-and-ink editorial changes to the test procedure when required after

testing commences. Editorial changes are limited to those correcting typographical errors. All other changes are considered technical and require SUPERVISOR approval. Technical changes are adjudicated by the SUPERVISOR's Engineering Support Desk by annotating on the test procedure prior to proceeding with the affected procedural steps.

3.2.5.1 Submit one legible copy, in approved transferrable media, of any editorial or SUPERVISOR approved technical changes made to the test procedure to the SUPERVISOR within one day of making the change.

3.2.6 Submit one legible copy, in approved transferrable media, of the completed test procedure no later than 1 day after test completion.

3.3 Manage the Total Ship Testing Task Group (TSTTG) to coordinate the test program in accordance with Section 092c of 2.2.

3.3.1 The group must consist of representatives of the SUPERVISOR (acts as Chairman), Contractor, AIT Team(s) on scene, Ship's Force, and others as requested by the SUPERVISOR or LMA (See 4.8) and must meet weekly unless otherwise directed by the SUPERVISOR.

3.3.2 Evaluate and document all problems impacting schedule and/or satisfying technical requirements.

3.3.3 Maintain agendas and minutes. Agendas must include tests completed since last meeting, tests not completed as scheduled with explanation and plan to resolve, issues impacting testing, and tests scheduled within the next 2 weeks. Minutes must include a list of attendees, action items with assignments, highlights of proceedings, and identified problems with potential impact.

3.3.4 Distribute minutes and changes to the CTP and ITSTP to TSTTG members no later than 2 business days after each meeting.

3.4 Manage Total Ship Testing.

3.4.1 Accomplish the requirements of the ITSTP of 3.1.

3.4.2 Incorporate all updates to ITSTP and status of Total Ship Testing including growth and new work no later than 48 hours after each TSTTG meeting.

3.4.3 Coordinate testing in accordance with the ITSTP.

3.4.4 Coordinate stationing of test personnel in accordance with the ITSTP. Provide test procedures and test data sheets to test personnel.

3.4.5 Coordinate the performance of each test procedure and record test results.

#### 4. NOTES:

##### 4.1 Test stage examples, not all inclusive.

###### Stage 1 – Material Receipt Inspection and Shop Tests:

- Physical inspection of new material, equipment and systems, and associated documentation.
- Ensure receipt of equipment is in good physical condition.
- Formal test procedure not required typically.

###### Stage 2 – Shipboard Installation Inspection and Tests:

- Cable integrity verification and insulation resistance checks.
- Hydrostatic tests of piping systems.
- Coolant flushing.
- Pre-energizing tests.

###### Stage 3 – Equipment Tests:

- Equipment element level initial light off, diagnostic and functional tests.
- Hinged/retractable mast operational test.
- Shaft torsion meter performance test.

###### Stage 4 – Intra-System Tests:

- Propulsion seawater cooling system operational test.
- Auxiliary propulsion system operational test.
- Diesel generator parallel and reverse power load bank test.
- System local area network interface test.
- Navigation system alignment verification.

###### Stage 5 – Inter-System Tests:

- Search radar distribution & display interface test.
- SPS-73 external interface test.
- AN/SPQ-9B video and trigger verification.
- AN/SPN-41A stabilization verification.
- Integrated propulsion test.

###### Stage 6 – Special Tests:

- EMI Phase I test (dockside).
- Hull generated IMI test.
- Data Link operational demonstrations dockside.
- SSDS MK 2 MOD 4B Combat System Integration test (dockside).

###### Stage 7 - Trials Tests:

- Radar set operational test (at sea).
- EMI Phase I test (at sea).
- Landing system correlation verification test (at-sea).
- Propulsion plant performance tests.
- SSDS MK 2 MOD 4B detect to engage demonstration (at sea).

4.2 GFI required to develop the ITSTP may include: Portions of Integrated Test Package (ITP), FMA/FMR Work Schedule, Ships Force Work List (SFWL), IDIQ, Test Index, and known AIT test requirements unavailable to the contractor.

4.3 Coordination of preparations for Sea Trials, including the test schedule for all planned underway testing will be included with the requirements of 009-60 of 2.1.

4.4 The Test Schedule is composed of the export of Integrated Production Schedule (IPS) data elements, developed in accordance with 009-60 of 2.1, sorted to include only test work activities.

4.5 The ship's Commanding Officer will provide personnel for recording data during testing.

4.6 Special purpose test equipment and software are defined as having unique functions and whose use is controlled and managed by an outside activity.

4.7 This standard item interfaces with 009-01 and 009-04 of 2.1 for test and inspection records.

4.8 The Lead Maintenance Activity (LMA) is defined in 2.5. MSRA/ABR contractors tasked with availability schedule management under 009-60/009-111 of 2.1 are considered the LMA.



NAVSEA  
STANDARD ITEM

FY-24

ITEM NO: 009-69  
DATE: 25 OCT 2022  
CATEGORY: I

1. SCOPE:

1.1 Title: Heavy Weather/Mooring Plan; provide

2. REFERENCES:

2.1 845-6686999 US Navy Vessel Water Depth, Mooring and Hull/Appendage Clearance Requirements for Transit and Berthing

2.2 DDS 582-1, Design Data Sheet, Calculations for Mooring Systems

2.3 S9086-TW-STM-010/CH-582, Mooring and Towing

2.4 UFC 4-159-03, Mooring Design

3. REQUIREMENTS:

3.1 Maintain a written Heavy Weather Plan that must be implemented during gales, storms, hurricanes, and destructive weather, including mooring calculations in accordance with 2.1 and 2.2, using 2.3 and 2.4 for guidance. The documented Heavy Weather Plan must be submitted to the SUPERVISOR for a document review and acceptance. The contractor must have an acceptable documented Heavy Weather Plan, in accordance with this Standard Item, in place no later than 15 days prior to availability start date. The Heavy Weather Plan must be subject to periodic conformity audits by the SUPERVISOR throughout the contract.

3.1.1 Submit updated or changed plans to the SUPERVISOR as they occur.

3.2 Ensure that the plan designates responsibility and implements procedures for prevention of damage to naval ships, craft, barges, and lighters. This includes periods when ships, craft, barges, and lighters are physically located in private contractors' plants; during times when work on ships, craft, barges, and lighters at naval facilities requires openings to hulls or decks; and when contractor owned/furnished floating equipment is tied alongside ships, craft, barges, and lighters.

3.2.1 The plan must contain specific responsibilities and detailed actions to be taken during the weather conditions listed below.

3.2.2 Conditions where there is substantial advance warning for approaching adverse weather are addressed by the following 4 categories:

3.2.2.1 Gale/Storm/Hurricane Condition IV: Trend indicates a possible threat of destructive winds of force indicated within 72 hours.

3.2.2.2 Gale/Storm/Hurricane Condition III: Destructive winds of force indicated are possible within 48 hours.

3.2.2.3 Gale/Storm/Hurricane Condition II: Destructive winds of force indicated are anticipated within 24 hours.

3.2.2.4 Gale/Storm/Hurricane Condition I: Destructive winds of force indicated are anticipated within 12 hours or less.

3.2.3 Conditions where there is little or no advance warning for approaching adverse weather are addressed by the following 2 categories:

3.2.3.1 Thunderstorm/Tornado Condition II: Destructive winds accompanying the phenomenon indicated are reported or expected in the general area within 6 hours. Lightning and thunder are also anticipated.

3.2.3.2 Thunderstorm/Tornado Condition I: Destructive winds accompanying the phenomenon are imminent. Lightning and thunder are also anticipated.

3.3 Ensure that the plan contains, as a minimum, the following information as dictated by conditions listed in 3.2:

3.3.1 Steps to be taken to remove or secure staging items or equipment on decks of ships, craft, barges, and lighters, pier or dry dock, including cranes that could become wind-borne.

3.3.2 Protection of ships, craft, barges, and lighters from damage from other floating equipment, such as barges, doughnuts, work floats, and other ships, craft, barges, and lighters.

3.3.3 Provisions for protection of government equipment and material in custody of the contractor from damage by pierside flooding.

3.3.4 Provisions for removal of temporary hoses, welding lines, air lines, oxygen/acetylene lines, etc., extending through watertight closures.

3.3.5 Provisions for security, emergency fire and flooding protection, emergency shipboard dewatering and fire main capability, emergency shipboard electrical generation, and emergency shipboard communications.

3.3.5.1 Specific requirements for emergency shipboard fire main capability are shown on Attachment A.

3.3.5.2 The minimum requirements for emergency shipboard electrical generation equipment are shown on Attachment B.

3.3.5.3 One portable dewatering pump and associated equipment for each 100 feet of ship's length in addition to the dewatering equipment provided by 009-08 of 2.1 must be available on the damage control or main deck adjacent to damage control lockers or temporary damage control equipment boxes. Pumps must be capable of providing a minimum of 200 gal/min at a discharge head of 50 feet of dewatering capacity and can be used at the scene of a casualty within 3 minutes of receiving an alarm. Additional dewatering capacity to provide 1,000 gal/min at a discharge head of 50 feet at the scene must be available within 15 minutes. During the waterborne overhaul period, no damage control system associated with flooding prevention and control or any portion thereof must be removed or made inoperable without prior notification of the SUPERVISOR and to the casualty-control station and until a back-up system has been established.

3.3.6 Provisions for access to the ship for personnel and emergency equipment during and immediately following the storm consistent with prudent safety precautions.

3.3.7 Assurance that all hull/deck openings are made watertight.

3.3.8 Steps to be taken to secure floating piers during high winds/high tides.

3.3.9 Provisions for messing contractor, Ship's Force, and SUPERVISOR duty personnel for 3 days (minimum). The maximum number of Navy personnel will be 15.

3.3.10 The name and telephone number (business and residential) of the private contractor's single point of contact. This person must have the authority to commit the contractor to take necessary actions as requested by the SUPERVISOR.

3.3.11 Provisions for operation and manning of a Hurricane Control Center, with capabilities of telephone and portable radio communications with the ship and SUPERVISOR duty personnel.

3.4 Ensure that the plan contains the following mooring related information:

3.4.1 Specify steps to be taken to secure ships, craft, barges, and lighters to contractor's pier, dry dock, graving dock, marine railway, or contractor's other facility. Information must define specific precautions to be taken and supporting calculations, to include limits of docking blocks and dock stability for both normal and heavy weather conditions. Calculations for heavy weather configurations must include wind and tidal considerations.

3.4.1.1 Provide the heavy weather state at which the ship must be undocked.

3.4.2 Submit mooring calculations for the worst anticipated loading condition during the availability. For ships with a self-compensating fuel system, the loading condition must show the self-compensation fuel system full of water, fuel, or some combination of fuel and water, projecting the worse possible condition as shown in calculations for maintaining ship's stability. Determine the combined loading due to wind load from each direction and both peak flood and ebb current loads at low and high tides. Calculations may require re-submittal if significant changes occur from the original estimate on which the calculations were based.

3.4.3 For ships in dry dock, provide limits and supporting calculations for listed conditions. Analyze both the "normal" dock configuration and the "heavy weather" configuration.

3.4.3.1 Maximum safe wind speed and surge for side block strength and stability. Include maximum loading of the side blocks on ship.

3.4.3.2 Maximum safe wind speed and surge for dry dock strength and stability.

3.4.3.3 Surge required to float ship.

3.4.3.4 Table or graph showing safe combinations of wind speed and surge.

3.4.4 For ships pierside, provide limits and supporting calculations for ship loading conditions specified in 3.4.2. Analyze the "heavy weather" mooring configuration that would be used during the conditions specified in 3.2. Analyze worst-case wind directions including frontal, broadside, and quartering.

3.4.4.1 Maximum safe wind speed for mooring strength. Include strength of pier, pier fittings, mooring lines, and shipboard fittings. Maximum applied load on any mooring line must be the breaking strength of the mooring line divided by 2.5 (factor of safety of 2.5).

3.4.4.2 Maximum safe surge for mooring.

3.4.4.3 Maximum safe elongation of mooring lines. Include the following information:

Size and type of mooring line;  
Percent elongation of mooring line at failure;  
Tattletale-free length and length between attachments.

3.4.4.4 Sketch, showing size, type, and location (vertical and horizontal angles) of all securing devices including fenders, bumpers, and camels.

3.4.5 Include the following statement, providing the necessary data:  
USS \_\_\_\_\_ can be safely moored to withstand a maximum of \_\_\_ mph winds with a \_\_\_ knot current and a \_\_\_ foot storm surge.

4. NOTES:

4.1 The SUPERVISOR will set Conditions of Readiness consistent with the forecasts and advisories of the local Weather Service Office of National Oceanic and Atmospheric Administration (NOAA).

4.2 NOAA defines the 5 categories of hurricanes as follows:

<u>CATEGORY</u>	<u>WIND SPEED</u>	<u>STORM SURGE</u>
1	74 - 95 MPH	OR 4 - 5 FT ABOVE NORMAL
2	96 - 110 MPH	OR 6 - 8 FT ABOVE NORMAL
3	111 - 129 MPH	OR 9 - 12 FT ABOVE NORMAL
4	130 - 156 MPH	OR 13 - 18 FT ABOVE NORMAL
5	157 MPH OR HIGHER	OR GREATER THAN 18 FT ABOVE NORMAL

4.3 Attachment C contains regional heavy weather conditions based on historical data and is provided as information only; the historical data is not intended to place limitations/restrictions on other values appropriate and/or previously authorized by a Naval Supervising Activity for their cognizant contractor(s) sites.

4.4 The Heavy Weather Plan submitted in 3.1 requires a one-time submittal/acceptance unless this NAVSEA Standard Item and/or references change or contractor's status changes.

ATTACHMENT A  
FIRE PROTECTION WATER SUPPLY REQUIREMENTS

<u>SHIP TYPE</u>	<u>FLOW, GPM</u> *	
AG	Miscellaneous Auxiliary Ship	1,500
AGM	Missile Range Instrumentation Ship	1,500
AGOR	Oceanographic Research Ship	500
AGS	Surveying Ship	1,000
AH	Hospital Ship	1,000
AK	Cargo Ship	1,500
AKR	Vehicle Cargo Ship	1,500
AO	Oiler	1,500
AOE	Fast Combat Support Ship	1,500
ARC	Cable Repair and Laying Ship	1,000
ARS	Salvage Ship	500
AS	Submarine Tender	1,500
ATF	Ocean Tug Fleet	500
CVN	Aircraft Carrier	3,000
CG	Guided Missile Cruiser	1,000
DDG	Guided Missile Destroyer	1,000
LCC	Amphibious Command Ship	1,000
LCS	Littoral Combat Ship	1,000
LHA	Amphibious Assault Ship	2,500 **
LHD	Amphibious Assault Ship	2,500
LPD	Amphibious Transport Dock	1,500 ***
LSD	Landing Ship Dock	2,000 ***
YRB	Repair and Berthing Barge	500
YRBM	Repair, Berthing and Messing Barge	500
YRBL	Repair, Berthing and Messing Barge (large)	500
MCM	Mine Counter Measures Ship	750
PC	Patrol Coastal	500

\* All flows are from the pier or dry dock outlet and are available at adequate residual pressures from those systems in compliance with present design criteria for dry docks and piers as reflected in NAVFAC design manuals (UFC 4-213-10, UFC 4-213-12, UFC 4-150-01, UFC 4-150-02, and UFC 4-150-06).

\*\* Includes supply to operate 2 hangar sprinkler groups and 2, 2-1/2-inch hoselines.

\*\*\* Includes supply to operate one sprinkler group and 2, 2-1/2-inch hoses.

ATTACHMENT B  
HEAVY WEATHER  
EMERGENCY POWER REQUIREMENT

<u>SHIP TYPE (NOTE 3)</u>			<u>MINIMUM POWER REQUIREMENT (KILOWATTS EXCEPT AS NOTED)</u>
AGM		Missile Range Instrumentation Ship	
AGOR	11, 23	Oceanographic Research Ship	
AGOS	1	Ocean Surveillance Ship	109
AGOS	19	Ocean Surveillance Ship	246
AGS		Survey Ship	221
AH		Hospital Ship	628
AK		Cargo Ship	
AKR		Vehicle Cargo Ship	
AO	105, 143, 187	Oiler	
AO	177CL		373
AO	177 (JUMBO)	Oiler	451
AOE	1CL	Fast Combat Support Ship	436
AOE	6	Fast Combat Support Ship	1,090
AOT	168	Transport Oiler	
APL		Berthing and Messing Barge	
ARC		Cable Repair and Laying Ship	264
ARDM		Medium Auxiliary Repair Dock	
ARS	50CL	Salvage Ship	100
AS	39, 40, 41	Submarine Tender	653
ATF	91, 113	Ocean Tug Fleet	16
CG	47CL	Guided Missile Cruiser	638
CG	52CL		623
CVN	68-70	Aircraft Carrier (Nuclear)	2,491
CVN	71		
CVN	72		
DDG	51CL	Guided Missile Destroyer	1,121
LCC	19, 20	Amphibious Command Ship	436
LCU*		Landing Craft	
LHA	1CL	Amphibious Assault Ship	840
LHD	1CL		
LPD	17CL	Amphibious Transport	1,050
LSD	41CL	Landing Ship Dock	334

\* Type includes ASDV, YFU, YFB

ATTACHMENT B  
(CONT)

HEAVY WEATHER  
EMERGENCY POWER REQUIREMENT

			MINIMUM POWER REQUIREMENT (KILOWATTS <u>EXCEPT AS NOTED</u> )
<u>SHIP TYPE</u> (NOTE 3)			
MCM	1	Mine Countermeasures	80
PC		Patrol Coastal	50
		Combatants	(NOTE 2)
YD		Floating Crane	
YRB		Repair & Berthing Barge	
YRBM		Repair, Berthing and Messing Barge	
YTB		Harbor Tug (Large)	
		Yard Craft (Misc.)	

GENERAL NOTES: The power requirement listed is the minimum considered necessary for emergency power if the main source of shore power is lost during heavy weather situations. Each contractor's heavy weather plan must specify the individual power capacity for each ship connected to the ship's shore power distribution system. Electrical information referenced from MIL-HDBK-1025/2.

NOTES:

1 - CAPACITY IS GIVEN IN KW. UNLESS OTHERWISE INDICATED. INPUT VOLTAGE IS 450 VOLTS, 3 PHASE, 3 WIRE, 60 HERTZ, UNGROUNDED. POWER FACTOR IS APPROXIMATELY 0.8.

2 - REQUIREMENT IS TO SUPPORT AN EXISTING PORTABLE MOTOR GENERATOR SET WHICH CONVERTS THE 60 HERTZ POWER TO 400 HERTZ POWER. THE MOTOR GENERATOR SET NORMALLY ACCOMPANIES THE SHIP SUPPORT FACILITIES.

3 - POWER REQUIREMENTS FOR ANY SHIP TYPE NOT LISTED MUST BE DETERMINED BY COMPARISON WITH A SHIP(S) OF SIMILAR DESIGN LOAD AND APPROPRIATE SHIP'S INFORMATION BOOK.



ATTACHMENT C  
HEAVY WEATHER CONDITIONS

SITE	WIND (Knots)	CURRENT (Knots)	SURGE (Feet)
Bath, ME	83	2.5	8.7
Portsmouth NSY, NH	84	3.8	12.8
SUBBASE New London, CT	87	0.2	10.8
Norfolk NSY, VA	82	0.4	8.9
NAVSTA Norfolk, VA	87	0.8	8.4
NAB Little Creek, VA	91	0.3	7.1
Newport News Ship Building, VA	87	1.3	8.4
SUBBASE Kings Bay, GA	96	0.3	9.1
NAVSTA Mayport, FL	96	3.1	7.5
NAVSTA Pascagoula, MS	104	Negligible	6.1
NAVSTA Ingleside, TX	109	2	16.2
NAVSTA Everett, WA	74	0.6	14.4
SUBBASE Bangor, WA	64	1.1	14.7
Puget Sound NSY, WA	64	0.5	15.4
NAS North Island, CA	52	0.6	8.4
Pearl Harbor NSY, HI	87	Negligible	3.5
Guam	122	2	4.7
La Maddelana, Italy	89	Negligible	Not Available

NAVSEA  
STANDARD ITEM

FY-24

ITEM NO: 009-70  
DATE: 25 OCT 2022  
CATEGORY: I

1. SCOPE:

1.1 Title: Confined Space Entry, Certification, Fire Protection, Fire Prevention and Housekeeping for Unmanned Vessels; accomplish

2. REFERENCES:

2.1 Standard Items

2.2 29 CFR Part 1915, Occupational Safety and Health Standards for Shipyard Employment

2.3 29 CFR Part 1910.134, Occupational Safety and Health Standards, Respiratory Protection

2.4 NFPA Standard 312, Standard for Fire Protection of Vessels During Construction, Repair, and Lay-up

2.5 American Conference of Government Industrial Hygienists (ACGIH) Threshold Limit Values for Chemical Substances and Physical Agents

2.6 NAVSEA OP-4, Ammunition and Explosives Safety Afloat

3. REQUIREMENTS:

3.1 Comply with the requirements of 2.2 through 2.4 and this item for an unmanned vessel to determine whether or not an explosive or other dangerous atmosphere exists in tanks, spaces, and associated piping, including adjacent tanks, spaces, and piping, aboard the craft and control hot work and entry to those spaces to preclude damage to the craft or injury to personnel during the accomplishment of this Job Order.

3.1.1 Submit one legible copy, in approved transferrable media, of a list of tanks or spaces to be opened or certified to the SUPERVISOR at least one day prior to opening the tank or void.

3.1.1.1 Comply with additional requirements NAVSEA Standard Items when accomplishing work in Collection, Holding and Transfer (CHT) and Motor Gasoline (MOGAS) tanks, spaces, or associated piping.

3.1.1.2 For fuel tanks or spaces that contain or have contained fuel, including F-76 and JP-5, in addition to the atmospheric testing required by 2.2, test for diesel fuel (CAS No. 68334-30-5; 68476-30-2; 68476-31-3; 68476-34-6, 77650-28-3) as total hydrocarbons in accordance with 2.5, and record total hydrocarbon test results on the Marine Chemist Certificate or Competent person's tests/inspection record.

3.1.2 Provide initial and annual update training for Competent Persons by utilizing a National Fire Protection Association (NFPA) Certified Marine Chemist or NFPA Instructor. The length of the initial training class must be at least 24 hours. Annual update training must be at least 8 hours.

3.1.2.1 Maintain a current roster of designated Competent Person(s) and copies of certificates of completion for the training required in 3.1.2 for reference by the SUPERVISOR. Submit one legible copy, in approved transferrable media, of the specific documents when requested by the SUPERVISOR.

3.1.3 Post a copy of the Marine Chemist Certificate, Certified Industrial Hygienist's test/inspection record, or Competent Person's test/inspection record at each access to the affected space while work in the space is in progress. When requested, a copy of the MCC or test/inspection record must also be delivered to a location designated by the SUPERVISOR. In the event that the space is identified to be NOT SAFE FOR WORKERS or NOT SAFE FOR HOT WORK, the space must be posted accordingly and other affected contractors, the SUPERVISOR and Ship's Force (if applicable) must be notified immediately. The posted copy must be clearly visible and legible.

3.1.3.1 Initial certification of spaces that require a Certified MCC or Certified Industrial Hygienist's test/inspection record in support of work operations must be effective until conditions change which would void the certificate or test/inspection record. A Competent Person must conduct the same Atmosphere testing as annotated on the MCC Certified Industrial Hygienist's test/inspection record.

3.1.3.2 For those certified spaces which employees will enter, a Competent Person must visually inspect, test and record each space certified as ENTER WITH RESTRICTIONS or SAFE FOR WORKERS as often as necessary, and as a minimum, prior to entry by employees on a daily basis. If a space is not to be entered on any given day, it is not required to be inspected and tested by a Competent Person. The initial MCC remains valid if conditions have not changed, unless noted on the MCC.

3.1.3.3 For those certified spaces affected by hot work, a Competent Person must visually inspect, test and record each space certified as SAFE FOR HOT WORK as often as necessary and, as a minimum, daily prior to commencement of hot work to ensure that conditions established by the certificate are maintained. When hot work is continuous, the affected spaces must be visually inspected, tested, and recorded on a daily basis to maintain the SAFE FOR HOT WORK certification.

3.1.3.4 If a Competent Person finds that the conditions within a certified space fail to meet the applicable requirements for which it was certified, work in the space must be stopped and may not be resumed until the space has been recertified by a Marine Chemist.

3.1.3.5 For those spaces where only Competent Person tests and inspections are required in accordance with 2.2, a Competent Person must visually inspect and test each space as often as necessary and, as a minimum, daily prior to entry or commencement of hot work to ensure that conditions are safe.

3.1.3.6 After the Competent Person has determined initially that a space is safe for entry and finds subsequently that the conditions within the tested space fail to meet the requirements of 2.2, work must be stopped until the conditions in the tested space are corrected, the space is retested, reinspected, and a new record of tests/inspections is recorded and posted.

3.1.3.7 Allow Navy civilian and military personnel to enter under the certificate or test / inspection record for inspection purposes.

3.1.4 Tank cleaning personnel must be trained annually on safety practices to include a discussion of safety information found in Subparts A, B, and Section 1915.152 of Subpart I of 2.2.

3.1.5 Maintain a current roster of the names of the Shipyard/Plant Rescue Team Members, along with contractor certification that training requirements of Subpart B of 2.2 have been accomplished and are current for each Rescue Team Member, or documentation of arrangements made for an outside rescue team to respond promptly to a request for rescue service in a contractor facility. Submit one legible copy, in approved transferrable media, of the specific documents when requested by the SUPERVISOR.

3.1.5.1 At a naval facility, the Navy will respond.

3.1.6 Spaces that are determined to contain Immediately Dangerous to Life or Health (IDLH) atmospheres must never be entered except for emergency rescue or for short duration for installation of ventilation equipment in accordance with 2.2 and 2.3. When entering IDLH spaces for the purpose of installing ventilation, notify the SUPERVISOR prior to entry. Notifications of rescue must be made as soon as management becomes aware of such an event.

3.1.7 Confirm that all personnel have exited the space prior to closure of tanks, voids, and cofferdams. Designate one person to account for all personnel who may have entered the space.

3.2 Provide a written notice for each job or separate area of hot work aboard craft.

3.2.1 The notice must state a description of the work to be done, the specific location, to include compartment number, of the hot work, and compartments adjacent to decks, bulkheads, and similar structures upon which hot work is to be accomplished, the time hot work will commence, current gas-free status of the area (if required), the absence or existence of

combustible material within 35 feet in any direction of the operation (or further, if affected by the operation), and if combustible material exists, what action must be taken to protect the material from fire, the provision and assignment of a fire watch, and the affirmation that conditions at the work site (ventilation, temporary lighting, accesses) permit the fire watch(es) to have a clear view of and immediate access to all areas included in the fire watch.

3.2.2 The notice must affirm that a suitable, fully-charged fire extinguisher must be available at the work site and provide for an inspection of the area 30 minutes after completion of the hot work or the cessation of hot work at the work site unless the contractor's Hot Work Supervisor surveys the affected work area and determines that there is no further fire hazard as the final action to complete the notice.

3.2.3 The notice must be signed by a supervisor specifically designated as responsible for coordination of the hot work and the fire watch requirement for each shift where hot work is being conducted.

3.2.4 One copy of each notice must be given to the SUPERVISOR when requested and at a minimum, one copy of each notice must also be conspicuously posted at the location where the hot work is being accomplished.

3.2.4.1 Deliver written notification of hot work planned Tuesday through Friday to the SUPERVISOR at least 30 minutes and not more than 24 hours preceding start of work.

3.2.4.2 Deliver written notification of hot work planned over a weekend or Monday following that weekend to the SUPERVISOR no later than 0900 on the Friday immediately preceding that weekend.

3.2.4.3 Deliver written notification of hot work planned on a federal holiday and on the day following the federal holiday to the SUPERVISOR no later than 0900 of the last working day preceding the federal holiday.

3.2.4.4 The notice must be effective for 24 hours unless a shorter period is specified in the contract or the gas-free status of the work area or system requires stopping the work. A new notice is required if work is interrupted due to loss of gas-free status.

3.3 Provide trained fire watches, at all affected areas where hot work is being accomplished. Provide fire extinguishing equipment as described in 2.2, and 2.4.

3.3.1 The program utilized to train fire watches must be in accordance with the requirements of 2.2 and include steps to be taken by the fire watch and hot work operator prior to accomplishment of hot work, proper selection and use of fire extinguishing equipment and other safety equipment, relationship between the fire watch and hot work operator, proper fire reporting procedures and other sounding of fire alarms, and reporting of fires to the ship's Quarterdeck. A means of communicating between all fire watches and their corresponding hot workers must be provided. This training must include theory and practical (hands-on) fire

suppression techniques. This training must be provided to all newly assigned fire watches, with annual updates provided to personnel. Provide visible means of identifying trained fire watches, i.e., badge, sticker, vest, etc.

3.3.1.1 Submit one legible copy, in approved transferrable media, of the training program when requested by the SUPERVISOR.

3.3.2 Each fire watch attending worker(s) accomplishing hot work must be equipped with a fully-charged and operable fire extinguisher, have immediate access and an unobstructed view of the affected hot work area to which they are assigned and must remain at the work site for 30 minutes from the time the hot work is completed unless the contractor's Hot Work Supervisor surveys the affected work area and determines that there is no further fire hazard.

3.3.2.1 The fire watch must not accomplish other duties while hot work is in progress.

3.3.3 Where several workers are accomplishing hot work at one site, the fire watch must have a clear view of and immediate access to each worker accomplishing hot work.

3.3.3.1 No more than 4 workers must be attended by a single fire watch.

3.3.4 In cases in which hot material from hot work may involve more than one level, as in trunks, machinery spaces, and on scaffolding, a fire watch must be stationed at each level unless positive means are available to prevent the spread or fall of hot material.

3.3.5 In cases where hot work is to be accomplished on a bulkhead or deck, combustible material must be removed from the vicinity of the hot work on the opposite side of the bulkhead, overhead, or deck, and a fire watch must be posted at each location.

3.3.5.1 If multiple blind compartments are involved in any hot work job, fire watches must be posted simultaneously in each blind area.

3.3.6 Comply with the firefighting and fire prevention requirements of 2.6 prior to hot work operations in or adjacent to areas containing ammunition or explosives.

3.3.6.1 Hot work must not be conducted during any logistics or maintenance movement of ammunition or explosives.

3.3.7 No hot work must be performed without an operational general announcing system, i.e., Ship's 1MC, or a documented communication strategy approved by the SUPERVISOR.

3.4 Locate oxygen, acetylene, fuel gas, toxic, oxygen depleting (OD) gas supply systems off the craft. Manifolds connected to pierside supply systems may be placed on board as long as

they are equipped with a shutoff valve located on the pier. The pierside shutoff valve must be in addition to the shutoff valve at the inlet to each portable outlet header required by 2.2.

3.4.1 Oxygen, acetylene, fuel gas, toxic, and OD gas supply systems must be stored to prevent collisions by trucks, forklifts, falling objects, etc.

3.4.2 Liquid oxygen (LOX) tanks must be staged in designated locations on the quay wall/pier to be determined jointly by the contractor, Ship's Force, and the SUPERVISOR.

3.4.3 When gas cylinders are in use on board the craft, they must be located on the weather decks or in a location determined jointly by the contractor and the SUPERVISOR and must be secured in cylinder racks, and in an upright position. The number of in-use cylinders must be limited to those which are required for work in progress and which have pressure regulators connected to the cylinder valves. On-board reserve gas cylinders must not exceed one-half the number of in-use cylinders and must be located in a remote area of the weather decks or in a location determined jointly by the contractor and the SUPERVISOR. Reserve acetylene cylinders must be secured in an upright position.

3.4.4 When not in use, gas cylinders and manifolds on board must have valves closed, lines disconnected, protective cover (cap) in place, and must be secured. Acetylene cylinders must be secured in cylinder racks and in an upright position.

3.5 Each inert gas/oxygen depleting (OD) fuel gas and oxygen hose run must be positively identified with durable unique markings that include maintenance activity name, service type, location, and shore side shut-off points. Tags must be located (at a minimum) at the source, point of entry aboard ship, at each connection point (including quick disconnects), and termination point.

3.5.1 Unattended hose lines or torches are prohibited in confined spaces.

3.5.2 Unattended charged hose lines or torches are prohibited in enclosed spaces for more than 15 minutes.

3.5.3 All hose lines must be disconnected at the supply manifold at the end of each shift.

3.5.4 All disconnected hose lines must be rolled back to the supply manifold or to open air to disconnect the torch; or extended fuel gas and oxygen hose lines must not be reconnected at the supply manifold unless the lines were given a positive means of identification when they were first connected and the lines are tested using a drop test to ensure the integrity of fuel gas and oxygen burning system. Alternate procedures must be approved by the SUPERVISOR.

3.5.5 Upon completion of system hook-up, accomplish a pressure drop test to include the torch, hoses, and gauges.

3.5.5.1 Apply pressure to the system. Back off pressure by turning off the valve supplying gases to the system. If the pressure on the gauge drops, a leak in the system exists. If the pressure on the gauge does not drop, the system is tight.

3.5.5.2 After applying pressure, wait 2 minutes to ensure pressure does not drop.

3.5.6 The use of gas hose splitters is prohibited.

3.6 Use fireproof or fire-retardant covering in accordance with MIL-C-24576, such as fireproofed canvas, fire-resistant synthetic fabrics, non-combustible fabrics, metal covers in accordance with ASTM D6413, or other suitable materials, to protect ship's equipment from falling sparks or other potential sources of fire. Coverings must be in place prior to commencing hot work and be maintained throughout the hot work evolution. Proper documentation of fire retardancy must be available for review upon request.

3.6.1 Non fire-retardant temporary wooden structures located on the pier, dry dock edge, or in the dry dock (not including dry dock blocks) must be a minimum of 35 feet from the ship to prevent spread of fire.

3.6.2 Lumber, plywood, and staging boards, except that used for pallets, must be fire retardant in accordance with Category Two, Type II, of MIL-L-19140.

3.6.3 Storage of material aboard the craft must be limited to that which is required for work in progress.

3.6.4 Prior to bringing equipment or working material aboard the craft, its crating and packing must be removed. If the equipment or material may be damaged during handling, the crating and packing must be removed immediately after the equipment or working material is brought aboard and taken ashore for disposal. A small quantity of pallets may be staged in a location determined jointly by the contractor and the SUPERVISOR aboard the craft for use in materials handling operations.

3.6.5 The quantity of flammable and combustible liquids brought onboard must be kept to a minimum, must not exceed that necessary for one shift's use, and must not be left unattended.

3.6.6 Ensure at least one unobstructed access to each main and auxiliary machinery space.

3.7 Accomplish a safety, fire prevention, and housekeeping inspection, during each shift whenever work is in progress. Once each manned/regular workday, the inspection must be made jointly with the SUPERVISOR. Deviation from this requirement for availabilities less than 30 days in duration must be adjudicated by the SUPERVISOR.



3.7.1 Submit one legible copy, in approved transferable media, of request for deviation to the SUPERVISOR.

3.7.2 Submit one legible copy, in approved transferrable media, of a written report of the discrepancies and corrective actions, using Attachment A, to be taken to the SUPERVISOR within 4 hours after completion of the inspection.

3.7.3 Provide a safety representative to accomplish the safety, fire prevention, and housekeeping inspection, who at a minimum has completed the training required in 3.1.2 and the following OSHA Training Institute (OTI) courses or NAVSEA approved equivalents: 5410; Occupational Safety and Health Standards for the Maritime Industry, 3095; Electrical Standards.

3.7.3.1 Submit one legible copy, in approved transferrable media, of the certificates of completion for the required courses upon request by the SUPERVISOR.

3.8 Develop and implement a written fire safety plan in accordance with 2.2. Review the plan with contractor employees and subcontractors.

3.9 Ensure access to temporary firefighting equipment is not obstructed or restricted.

3.9.1 Ensure firefighting equipment is not relocated without written authorization from the SUPERVISOR. Provide a secure temporary storage facility for firefighting equipment that is moved from its original location.

3.10 Conduct a firefighting and fire prevention conference in conjunction with the arrival conference or no later than 5 days after start of the availability for availabilities in excess of 30 days. This conference must cover the contractor's fire safety and fire response plan for fire prevention and firefighting and the procedures that will be in use by the contractor and the region/installation or municipal fire and emergency services, as well as familiarize the contractor and the region/installation or municipal fire and emergency services with the craft arrangement, onboard fire prevention, and firefighting systems, equipment, and organization, and familiarize all parties with the scope of work and aspects of the work or craft conditions that have significance in fire prevention and firefighting.

3.10.1 The conference must specifically address the following matters:

3.10.1.1 Fire alarm and response procedures

3.10.1.2 Contractor firefighting capability and procedures

3.10.1.3 Region/installation or municipal fire and emergency services firefighting capability and procedures

3.10.1.4 Firefighting jurisdictional cognizance and incident command procedures

3.10.1.5 Communication system for fire reporting and control or firefighting efforts

3.10.1.6 Craft arrangement including access routes, availability or firefighting systems (installed and temporary), fire zone boundaries, and communication systems

3.10.1.7 Each Shipboard firefighting organization, systems, drills, and equipment to include rehabilitation procedures

3.10.1.8 Craft, space, and equipment security consideration

3.10.1.9 Compatibility of contractor, and region/installation or municipal fire and emergency services firefighting equipment

3.10.1.10 Industrial work scope, including location of craft, and effect on firefighting systems, access, and communications

3.10.1.11 The roles, responsibilities, and membership of the Fire Safety Council (FSC). Include the requirement to obtain permission from the FSC to perform work that affects the fire safety posture (e.g., securing the firemain, securing the 1MC, undocking, transferring fuel/lube oil) of the ship.

3.10.1.12 Hotwork monitoring and confined space practices.

3.10.2 The firefighting and fire prevention conference must include a table top fire drill.

3.11 Provide a portable 300 KW diesel generator with associated cables, lugs/plugs to supply emergency power during transits to and from dry dock when ship's emergency power cannot be used or anytime during the availability that the craft's power is not available as an emergency back-up to installed shore power.

3.12 Maintain available for review, prior to commencement of work, a fire safety plan meeting the requirements of 2.2. In addition to the requirements of 2.2, include and identify the method for reporting fires, the shipyard firefighting facilities, equipment, and organization (paid or volunteer), the procedures for maintenance of clear fire lanes in the shipyard and on the piers, and the nearest municipal firefighting organization, including the anticipated time of response.

3.13 Provide fire protection equipment consisting of:

3.13.1 Firefighting water, utilizing manifolds connected to a source capable of providing 150 GPM at 60 PSIG at the manifold must be in place before start of work.

3.13.1.1 The number of manifolds must be sufficient to permit reaching all points on the vessel (including underwater body when the vessel is in dry dock or on a marine railway) with 2, 1-1/2 inch hoses of not more than 100 feet in length.

3.13.1.2 Hoses must be attached to the manifolds and fitted with an all-purpose combination fog and straight stream nozzle.

3.13.1.3 Verify by the Pitot tube method or an in-line flow meter that the water volume and pressure meets these requirements.

3.14 Ensure access to temporary and Ship's Force firefighting equipment is not obstructed or restricted.

3.15 For Navy boats and craft, all paragraphs of this standard item apply except for 3.11.

3.16 For Navy boats and craft the SUPERVISOR may waive the requirements of 3.13. If authorized by the SUPERVISOR, a portable fire extinguisher (or an equivalent means for fighting a fire) in the immediate vicinity of where the work is performed can be used in lieu of fire main.

#### 4. NOTES:

4.1 In addition to CHT and MOGAS tanks, Hydrogen sulfide (H<sub>2</sub>S) may be found in AFFF, seawater, and firemain systems.

4.2 Booklet of General Plans and Tank Sounding Tables are available for review at the office of the SUPERVISOR.

4.3 The term "unmanned" is defined as without the physical presence of people in control; without a human operator.

4.4 A "quick disconnect" is a coupling or connecting device/system designed to permit easy and immediate separation of lines without the use of tools and to ensure the contents do not escape.

4.5 The term "annual" means once a year, not-to-exceed 12 months.

Fire Zone Boundaries

ATTACHMENT A

Attendees

ESH Discrepancy and Corrective  
Action Log

Ship name/hull number:

Location:

Prime Contractor:

Date:

Time:

No.	Point of Contact	Date Corrected	Location	Discrepancy	Corrective Action	Code

Type Codes: 1-Housekeeping, 2-Fire Prevent./Fire Equipment, 3-Hot Work., 4-FZ Boundary, 5-Electrical, 6-Compress Gas/Hoses/Bottles/Manifolds, 7-Scaffolding, 8-Egress/Exit, 9- Walking/Working Surfaces, 10-PPE, 11- Containment, 12-Unguarded/Edges/Holes/Openings/Fall Protection, 13- Confined/Enclosed Spaces, 14-Lines & Leads Hazards, 15-Equip. Adrift & Rollback, 16-Ventilation, 17-Machine Guarding/Hand Tools, 18- Crane/Rigging, 19-Environmental & Hazardous Material/Communication, 20-Environmental Protection, 21-General Safety

## ATTACHMENT A (Con't)

### ESH DISCREPANCY AND CORRECTIVE ACTION LOG INSTRUCTIONS

- 1- Fire Zone Boundaries: List the designated Fire Zone Boundaries.
- 2- Attendees: List Company and or Command and names of personnel present for walk thru.
- 3- Ship Name/Hull Number: Indicate ship name and hull number of the location of the walk thru.
- 4- Location: Indicate location where ship is moored or docked, i.e. name of contractor facility or pier at Naval Base or Station.
- 5- Prime Contractor: Indicate prime contractor who has the contract with the SUPERVISOR.
- 6- Date: Indicate date of walk thru being accomplished.
- 7- Time: Indicate start time (24 hour clock) of walk thru being accomplished.
- 8- No. (number): List sequentially, each discrepancy noted during the walk thru. Number will continue where the numbering left off the previous day, until the end of the availability.
- 9- Point of Contact: Indicate Company/Command identified with the discrepancy.
- 10- Date Corrected: Date condition was corrected. If condition is not corrected, condition will be carried over to the next walk thru until condition is corrected.
- 11- Location: Indicate location of the condition, i.e. space number or frame number.
- 12- Discrepancy: Indicate condition that needs corrective action, be specific as necessary.
- 13- Corrective Action: Indicate corrective action taken to correct the condition and who is responsible for the corrective action.
- 14- Code: Indicate code, located at the bottom of ATTACHMENT A that condition can be grouped with, i.e. lines on deck causing trip hazard would use code 14- Lines and Leads Hazards.

Type Codes: 1-Housekeeping, 2-Fire Prevent./Fire Equipment, 3-Hot Work., 4-FZ Boundary, 5-Electrical, 6-Compress Gas/Hoses/Bottles/Manifolds, 7-Scaffolding, 8-Egress/Exit, 9- Walking/Working Surfaces, 10-PPE, 11- Containment, 12-Unguarded/Edges/Holes/Openings/Fall Protection, 13- Confined/Enclosed Spaces, 14-Lines & Leads Hazards, 15-Equip. Adrift & Rollback, 16-Ventilation, 17-Machine Guarding/Hand Tools, 18- Crane/Rigging, 19-Environmental & Hazardous Material/Communication, 20-Environmental Protection, 21-General Safety

NAVSEA  
STANDARD ITEM

FY-24

ITEM NO: 009-71  
DATE: 25 OCT 2022  
CATEGORY: II

1. SCOPE:

1.1 Title: Piping System; test

2. REFERENCES:

2.1 Standard Items

2.2 S9086-RK-STM-010/CH-505, Piping Systems

2.3 S9086-RJ-STM-010/CH-504, Pressure, Temperature and Other Mechanical and Electromechanical Measuring Instruments

3. REQUIREMENTS:

3.1 Accomplishment of testing of each new and disturbed piping systems must be in accordance with 2.1 and 2.2. (See Note 4.2)

3.1.1 Each master and backup test gauge must conform to gauge range and graduation shown on Table 504-6-1 of 2.3. The backup gauge must be cross-checked to the master hydrostatic test gauge up to the maximum test pressure just prior to start of testing. Master and backup gauges must track within 2 percent of each other.

3.1.1.1 Each master and backup test gauge used for vacuum testing must consist of 2 compound gauges with a 30 inch-0-30 PSI range.

(I)(G) "VISUAL INSPECTION - SHOP TEST" (See 4.2)

3.1.2 Accomplish a shop hydrostatic test of replacement piping, fittings, and components that can be tested in the shop or cannot be tested and inspected IAW paragraph 3.1.3 after installing in to the ship's system for evidence of external leakage and/or deformation. Allowable external leakage and/or deformation: None.

(I)(G) "VISUAL INSPECTION - HYDROSTATIC, LOW PRESSURE AIR, VACUUM, OR OPERATING PRESSURE TEST" (See 4.2)

3.1.3 Visually inspect the pressurized system or system under vacuum for evidence of external leakage and/or deformation. Allowable external leakage and/or deformation: None.

3.1.3.1 Each joint requiring inspection must remain uninsulated and unpainted until completion of successful inspection. Each joint tested and inspected under 3.1.2 would not require re-inspection unless the joint was disturbed during installation. These joints can be insulated and painted.

3.1.3.2 Provide a sketch of that portion of the system to be tested, showing the location of blanks, isolation valves, test connection, joints previously tested/inspected under 3.1.2 and the location of air vents to vent air. Sketch must be on the test site during the accomplishment of the test.

3.2 Accomplish a static head pressure test of each new and disturbed gravity drain piping (unpressurized piping), using clean, fresh water for a minimum of 30 minutes. Allowable leakage: None.

3.3 Accomplish an operational test of each new and disturbed gravity drain piping for proper operation and unobstructed flow.

3.4 Accomplish an operational test of each new and disturbed sounding tube piping by inserting a 16-inch theft sampler into sounding tube until it bottoms. Accomplish the test a minimum of 4 times for each sounding tube. There must be no binding or sticking of sampler during this test.

3.5 Submit one legible copy, in approved transferrable media, reporting the results of the test listing the requirements of 3.2 through 3.4, including each location of the new and disturbed gravity drain/new and disturbed sounding tube piping to the SUPERVISOR.

#### 4. NOTES:

4.1 Boiler pressure vessel piping is defined as, "The piping from the pressure vessel drum or header up to the first valve off the pressure vessel drum or header."

4.2 If nondestructive testing of new and disturbed piping systems is required the use of Standard Item 009-12 "Weld, Fabricate, and Inspect; accomplish" of 2.1 will be specified in the work item.

4.3 Test pressure and test medium will be specified in invoking Work Item.

NAVSEA  
STANDARD ITEM

FY-24

ITEM NO: 009-72  
DATE: 25 OCT 2022  
CATEGORY: I

1. SCOPE:

1.1 Title: Physical Security at a Private Contractor Facility; accomplish

2. REFERENCES:

2.1 DODI 2000.16, DOD Antiterrorism (AT) Program Implementation: DOD Force Protection Condition (FPCON) System

2.2 33 CFR Part 165, Regulated Navigation Areas and Limited Access Areas

2.3 33 CFR Part 334, Danger Zone and Restricted Area Regulations

2.4 NAVFAC 20090329 PRF BB, Performance Specification for the Antiterrorism / Force Protection Boat Barriers

3. REQUIREMENTS:

3.1 The requirements of 3.2.6, 3.2.7, 3.2.8, 3.2.9 and 3.2.10 are Force Protection measures the Contractor must be able to meet at a Private Contractor Facility under Force Protection Conditions Normal, Alpha, Bravo, Charlie, and Delta, respectively. The solicitation must define the Force Protection Condition. Additional measures may be directed by the SUPERVISOR in accordance with 2.1. Implementation of any other measures, when directed by the SUPERVISOR, will be the subject of an equitable adjustment.

3.2 Provide a written plan which must be implemented for the protection of personnel, U.S. Naval vessels, Government-owned floating dry docks, work in process, and the material and equipment to be installed therein, at the Contractor's facility, which addresses the requirements of this Standard Item. The written plan must, as a minimum, be identified as "Controlled Unclassified Information (CUI)".

3.2.1 Provide written designation to the SUPERVISOR of the individual who will be in charge of the security effort.

3.2.2 Attend security coordination meeting with Ship's Force and the SUPERVISOR to brief the Contractor's security plan and procedures prior to security conference of 3.2.3.



3.2.3 Conduct a security conference with federal, state, and local authorities, Ship's Force, and the SUPERVISOR within 45 days prior to ship's arrival to ensure all parties are in agreement with the security procedures while the ship is in port.

3.2.4 Coordinate the establishment and enforcement of the land and water areas adjacent to U.S. Naval vessels as restricted areas or limited waterway areas in accordance with 2.2 or 2.3, in cooperation with the Navy, U.S. Coast Guard, and Army Corps of Engineers.

3.2.5 The Security Plan must include the roles and responsibilities for application of deadly force in the protection of US Navy assets and crew.

3.2.6 Under Force Protection Condition (FPCON) NORMAL, one step above FPCON ALPHA. Establish and maintain physical security boundaries, positive access controls, and other security measures to provide safeguards against hazards, including unauthorized entry, malicious mischief, theft, espionage, sabotage, and terrorism at Contractor's facility in accordance with Attachment A, to include the following:

- 3.2.6.1 Perimeter physical barriers
- 3.2.6.2 Perimeter openings control
- 3.2.6.3 Access and circulation control
- 3.2.6.4 Armed security force
- 3.2.6.5 Protective lighting
- 3.2.6.6 Signs and posting of boundaries
- 3.2.6.7 Security force communications
- 3.2.6.8 Random antiterrorism measures (RAM)

3.2.7 Under Force Protection Condition ALPHA, establish and maintain the following requirements in addition to 3.2.6:

- 3.2.7.1 Additional plant boundary protection
- 3.2.7.2 Assistance from state, local, and other law enforcement agencies
- 3.2.7.3 Increased personnel, property, and perimeter security checks
- 3.2.7.4 Increased security force manning commensurate with the additional actions directed under this section
- 3.2.7.5 Increased waterfront surveillance

3.2.7.6 Place vehicle barriers to reduce ease of vehicular access adjacent to the ship

3.2.7.7 Brief the security force and the SUPERVISOR concerning the threat, the security precautions being implemented, and what action is to be taken with respect to strangers, unidentified vehicles, abandoned parcels or suitcases, or unusual activity in or near the Contractor's facility.

3.2.7.8 Increase security spot-checks of vehicles, persons, and buildings near U.S. Naval vessels.

3.2.7.9 Limit access points for vehicles and personnel commensurate with performance of the Job Order.

3.2.7.10 Inspect 100 percent of commercial vehicles entering the controlled industrial area and/or piers.

3.2.7.11 Test procedures for mass notification.

3.2.7.12 Review requirements related to implementing additional security actions in the event of an increased threat.

3.2.7.13 Review barrier plans.

3.2.8 Under Force Protection Condition BRAVO, establish and maintain the following requirements in addition to 3.2.6 through 3.2.7:

3.2.8.1 Request the Captain of the Port or U.S. Coast Guard District Commander to activate the Naval Vessel Protection Zones in accordance with 2.2.

3.2.8.2 Establish communications with state, local, and other law enforcement, fire, and emergency management agencies.

3.2.8.3 At the beginning of each workday, as well as at random intervals, inspect the interior and exterior of buildings in regular use for suspicious packages. Secure and regularly inspect buildings, rooms, and storage areas not in regular use for unusual conditions or suspicious activity.

3.2.8.4 Clear the area within 100 feet (30.5 meters) of U.S. Naval vessels of all non-mission-essential materials and vehicles as determined by the SUPERVISOR.

3.2.8.5 Review requirements related to implementing additional security actions in the event of an increasing threat.

3.2.8.6 Identify paths for critical materials to maintain production.

3.2.8.7 Brief all employees working at the facility, including the ship's crew and subcontractor employees, concerning the threat, the security precautions being implemented and what action is to be taken with respect to strangers, unidentified vehicles, abandoned parcels, containers or suitcases, and any other suspicious or unusual activity.

3.2.8.8 Increase security presence and surveillance, and randomly inspect vehicles, persons and accompanying items entering the facility.

3.2.8.9 Review mail and material screening procedures at the facility.

3.2.9 Under Force Protection Condition CHARLIE, establish and maintain the following requirements in addition to 3.2.6 through 3.2.8:

3.2.9.1 Inspect the interior and exterior of buildings in regular use for suspicious activity or objects at frequent intervals.

3.2.9.2 Increase protection for crew berthing to reduce vulnerability.

3.2.9.3 List work that would be required to permit safe relocation of the vessel and its crew to the nearest Government facility as designated by the SUPERVISOR.

3.2.9.4 Determine work that will be stopped if the next higher Force Protection Condition is implemented. Determine a list of and inform mission-essential personnel, including Contractor work force. Communicate critical Work Items to the SUPERVISOR, ship's Commanding Officer, and/or Shipyard Commander.

3.2.9.5 Increase surveillance in and around waterside perimeter and facilities. Position floats, work boats, and barges along the sides of the U.S. Naval vessel and any occupied berthing barges to create a buffer zone.

3.2.9.6 Limit access points to strictly enforce entry control. Inspect all vehicles entering the controlled industrial area and/or pier. Review access procedures to ensure no unauthorized personnel gain access into the facility.

3.2.10 Under Force Protection Condition DELTA, establish and maintain the following requirements in addition to 3.2.6 through 3.2.9:

3.2.10.1 Immediately notify state and local law enforcement agencies and the U.S. Coast Guard of any knowledge of terrorist activity, suspicious persons or criminal activity.

3.2.10.2 Limit access points to the absolute minimum.

3.2.10.3 Strictly control all facility access points, ensure positive identification of all personnel, and search all vehicles and their contents, suitcases, briefcases, and packages entering the Contractor's facility.

3.2.10.4 Accomplish continuous security patrols of all areas of the facility, to include the waterfront, occupied by U.S. Naval vessels and personnel.

3.2.10.5 Prepare U.S. Naval vessels for movement away from the Contractor's facility when directed by the SUPERVISOR.

3.2.10.6 Discontinue work except that directly related to the integrity of the vessel and as otherwise directed by the SUPERVISOR.

3.2.10.7 Implement the plan to deny access to individuals not essential or critical to the overall mission of protecting and/or moving vital Navy assets onto the facility and occupied buildings.

3.3 Submit one legible copy, in approved transferrable media, of the plan to the SUPERVISOR for review and approval no later than 15 days prior to availability start date.

3.3.1 Accomplish the requirements of the approved plan.

3.3.2 Any changes at the Contractor's facility affecting physical security or the approved plan must be submitted to the SUPERVISOR for approval within 24 hours.

3.4 Provide procedures for coordinating the Contractor's security efforts with those of the SUPERVISOR, the Commanding Officer's designated representative, and any subcontractor when using the subcontractor's facility to host the vessel.

3.4.1 Identify whose physical security plan, prime or subcontractor, will be used for the availability.

3.5 Prepare an itemized statement of cost incurred for the work covered by this Standard Item that was necessary to meet Force Protection Conditions different from that specified in the solicitation. Submit one legible copy, in approved transferrable media, of the statement to the SUPERVISOR within 30 days of delivery or redelivery (as applicable) of the ship. The statement must itemize the total direct labor hours with the applicable direct labor rates, overhead, General and Administrative (G&A) and/or other indirect rates, material, material handling charges, subcontractor costs, Other Direct Costs (ODC), and freight costs (as applicable). Where final overhead rates are not available, use the most current billing rate(s).

3.5.1 The Government may perform an audit of the Contractor's statement of cost incurred. The Contractor, upon request, must make available to the SUPERVISOR all records, related correspondence, and the substantiating data upon which the statement of cost incurred is based.

4. NOTES:

4.1 U.S. Naval vessel means any vessel owned, operated, chartered, or leased by the U.S. Navy; any pre-commissioned vessel under construction for the U.S. Navy, once launched into the water; and any vessel under the operational control of the U.S. Navy or a Combatant Command.

4.1.1 For a non-nuclear new construction vessel in a private shipyard, a physical water barrier or a dedicated security boat, detailed in Attachment A, are applicable at Crew Move Aboard.

4.2 Controlled Industrial Area (CIA) means an area of the shipyard in which construction, conversion, repair, or overhaul of U.S. Navy vessels is conducted.

4.3 USFF AT OPORD 3300 (series) provides general security requirements for Fleet Activities. The SUPERVISOR will use this reference as a guide in applying force protection measures appropriate to the unique situation at each Contractor's facility.

4.4 A vehicle is defined as a means of transportation that transports people or objects.

4.5 Water Barrier, is a continuous, modular, floating barrier that can be installed in lengths ranging from a few hundred feet to over a mile. The barrier is primarily intended to stop and/or delay hostile high-speed waterborne craft 65 feet or less. A water barrier is but one element of an integrated system.

## ATTACHMENT A

### OTHER SECURITY MEASURES

#### 1. Perimeter Physical Barriers:

a. Physical barriers, including both natural (e.g., mountains, swamps, thick vegetation, rivers, bays, cliffs) and structural (e.g., Water Barriers, fences, walls, doors, gates, vehicle barriers) which control, delay, impede, and discourage access by unauthorized persons. To be effective, such barriers must be augmented by armed security force personnel or other means of protection and assessment.

b. Physical barriers must be employed along Contractor facility perimeters. The barrier or combination of barriers used must afford an equal degree of continuous protection along the entire perimeter.

c. Structural barriers such as fences or walls must be a minimum of 8 feet in height, and any uncontrolled opening must be securable to afford protection against unauthorized entry. New security and perimeter fencing must have a minimum fence fabric height of 7 feet, excluding top guard. Fence height including top guard outriggers must be a minimum of 8 feet. Modifications to existing fences are not required, provided the existing fencing is in good repair and has a minimum fence fabric height of 6 feet, excluding top guard.

d. The waterfront security required to protect the Navy asset is dependent on the asset. Damage to the dry dock gate could result in flooding of the dry dock resulting in possible damage or loss of the vessel. Therefore, the dry dock gate is not considered to be a physical or structural barrier and must be protected. Additionally, floating drydocks must be protected commensurate with the provisions for the docked asset.

e. Closed Circuit Television (CCTV) installs will be planned for installation by using Chapter 4 of the Unified Facilities Criteria (UFC) 4-021-02NF. Plans will be submitted to the SUPERVISOR for approval, prior to installation. This UFC document provides guidance on how to design electronic security systems required by the current antiterrorism/force-protection environment.

f. Barrier design will be in accordance with Tables 8, 9, 10, and 11 of 2.4. Table 9 Maximum Survival SOW will be 64. Table 11 Stopping Capability SOW will be 520,000 ft-lbf or more and required percent of small boats of 65 feet or less stopped is 99% or greater.

Asset	Security measures
For Patrol Coastal (PC), MSC	<ul style="list-style-type: none"> <li>- Adjacent landside security (patrols, surveillance, pier access control) no special requirements in waterways.</li> <li>- Identify restricted area waterways with buoys and signs.</li> </ul>
Surface combatants, Berthing Barges, Amphibious ships, mine warfare, auxiliary ships (USS only), and MSC Naval Auxiliary (Cargo-Laden), and MSC OCONUS repair facilities.	<p>The requirements above and</p> <ul style="list-style-type: none"> <li>- Security Zone per 3.2.4</li> <li>- Use of a water barrier, numbered Fleet Commander-approved barge or other physical barrier (dependent on expected geographic and environmental conditions as determined by the SUPERVISOR) per 1.d above, or other physical barrier approved by the numbered Fleet Commander.</li> <li>- In areas where the cognizant SUPERVISOR agrees the use of waterborne barrier(s) is not in the best interest of the US Navy, a dedicated waterborne security boat must patrol within 200 yards of the protected vessel equipped with a bullhorn, night vision device, spotlight, marine flares, lethal and non-lethal weapons, and a two-way communications device according to the specifications described in Addendum 1.</li> </ul> <p>** Note: If the primary security measure is unavailable, then the Private Contractor Facility must ensure adequate backup security measures are in place to maintain the security posture as per the associated FPCON</p>
Carriers, submarines (see next row for SSBN)	<p>The requirements above and</p> <ul style="list-style-type: none"> <li>- Electronic water/waterside security system to include, but not limited to, closed-circuit television for the purposes of surface craft detection.</li> <li>- Use water barriers to prevent direct unchallenged access from small boat attacks.</li> </ul>
SSBN	<p>The requirements above and</p> <ul style="list-style-type: none"> <li>- Per SECNAVINST S8126.1</li> <li>- Use water barriers to stop small boat threat</li> </ul>

2. Perimeter Openings: Openings in the perimeter barrier must be operated by the contractor and must be kept to the minimum necessary for the safe and efficient operation of the Contractor facility. Access through such openings must be controlled, or the openings must be secured.

3. Access and Circulation Control:

a. A system of personnel and vehicle movement control is required at Contractor facilities. The degree of control must be in keeping with efficient operations yet afford defense-in-depth to provide graduated levels of protection.

b. Armed or unarmed sentries may be assigned to check identification at pedestrian and vehicle entry control points to restrict and control movement by vehicles and unauthorized personnel from gaining access into the facility.

c. The facility must coordinate with the local postal and courier services in developing a plan for ensuring that all mail and courier delivered packages to the facility are properly screened by the delivery service prior to being delivered to the contractor facility's mailroom.

4. Armed Security Force: The Contractor security force must consist of designated persons specifically organized, trained, and equipped to provide physical security. Security Force must be armed with lethal and non-lethal weapons, and qualified in accordance Federal and/or State laws to carry and use firearms in the performance of protecting personnel and/or property.

5. Protective Lighting:

a. Protective lighting, to include work lighting, increases the effectiveness of security forces and has considerable deterrent value.

b. Contractors must provide adequate illumination to discourage or detect attempts to enter facilities and reveal the presence of unauthorized persons within such areas.

c. Lighting must support security force activities such as identification of badges and personnel at perimeter openings, surveillance of facility perimeter/avenues of approach, and inspection of unusual or suspicious circumstances.

6. Signs and Posting of Boundaries:

a. Trespass laws applicable to the jurisdiction in which the facility is located will govern signs and posting of perimeter boundaries at Contractor facilities.

b. Size, placement, and use of any language in addition to English should be appropriate for the stated purpose. Signs will read essentially as follows:

WARNING  
RESTRICTED AREA  
KEEP OUT



Authorized  
Personnel Only

c. Signs must be posted at regularly-used points of entry and at intervals along the facility perimeter such that any reasonable person would conclude that everyone crossing the boundary into the facility would have been informed of the above.

7. Security Force Communications:

a. The activity security force requires sufficient equipment to maintain continuous, secure 2-way voice communications between elements (fixed/mobile posts, and supervisory personnel) of the security force and U.S. Naval vessel's watch section. Establish communications between the Contractor's security force and the U.S. Naval vessel's watch section.

b. The facility must maintain a communication system for use in emergencies or crisis situations to facilitate effective two-way voice communications among state and local law enforcement agencies and the U.S. Coast Guard.

c. The facility must establish a communication system, pre-recorded and/or live-voice, but capable of broadcasting information to all building occupants or personnel in the immediate vicinity during or prior to an emergency or crisis situation.

8. Random Antiterrorism Measures (RAM): As a deterrent, randomly apply the measures from higher Force Protection Conditions and other RAM including:

- a. Keep personnel involved in implementing increased security requirements on call.
- b. Inspect deliveries to protect against the introduction of unauthorized material.
- c. Cars and other non-mission essential items must be moved 100 feet from U.S. Naval Vessels and buildings where the crew is located or work is in progress.
- d. Inspect mail for letter or parcel bombs.
- e. On entry of visitors to the facility, physically inspect them and accompanying items.
- f. Search vehicles entering the facility.
- g. Erect barriers and obstacles to provide additional traffic controls to areas where U.S. Naval Vessels and crews are located.
- h. Consult local authorities about closing public roads and facilities that might make sites more vulnerable.

i. Other site-specific RAM that must be incorporated into the Contractor's physical security plan and/or company-specific implementation procedures.

Addendum One to Attachment A  
of Standard Item 009-72

Waterborne Security Boats

Mission

The boats are primarily used to provide a dedicated waterborne presence and deterrence in the immediate vicinity of no more than three (3) U.S. Naval Assets. The word "dedicated" is defined as on-site, 24-hours a day, 7 days a week, and responsive solely to the operational confines of the protected asset(s). Normally, a single waterborne security boat will be designated for each U.S. Naval Asset. Waterborne security boats must be capable of conducting continuous patrols in the immediate vicinity of the protected asset(s), or continuous monitoring of a patrol zone when assigned to protect clustered U.S. Naval Assets (a patrol zone must not exceed 200 yards and must not include more than 3 protected assets).

Waterborne security boats will be used to provide restricted area enforcement by providing a layered defense and deterrence mechanism. This includes the ability for early detection of intruders under day/night, and all-weather conditions.

Projected Operating Environment

The projected operating environment of the waterborne security boats will normally be in protected harbors or inland waterways. These boats will be expected to operate in varying temperatures depending on the climate at the location the boat(s) will be used. Temperatures can be expected to vary from below 32 degrees Fahrenheit to above 100 degrees Fahrenheit. Storm conditions and warnings often issued in the operating environment include: small craft, gale, storm, and hurricane warnings.

General Characteristics

There are no specific hull material requirements for waterborne security boats. Waterborne security boats must be visible from distances of at least 500 yards to the unaided eye, during periods of unrestricted visibility and must possess all safety equipment required by federal and local regulations. Waterborne security boats must also display a placard on both sides of the vessel with the word "Security" of sufficient size and reflective composition to be visible from 500 yards to the unaided eye, during periods of unrestricted visibility (250 yards during periods of low-light) and in accordance with federal and local regulations. These boats must possess a hailing mechanism capable of warning/hailing approaching craft at 500 yards. Hailing capability may consist of modified human voice (e.g., through the use of a bull horn, PA system, etc.), or mechanical (e.g., siren, pulsating tone, etc.).

The boat must have a weather resistant spot/flood light capable of rotating 360 degrees with instant start/restart and at least 6,000,000 candlepower.

The boat must have a fully operable marine band radio (VHF).

Length range: 27 feet to 40 feet And why:

This size is necessary for safety and mission accomplishment, ease of discernment, crew accommodation, visual deterrent, and ease of maneuverability when responding to contacts of interest during all-weather patrols.

Breadth 8 feet 6 inches And why:

The minimum breadth of 8 feet 6 inches is necessary to provide a stable platform, crew accommodation, visual deterrent, ease of maneuverability, safety and mission accomplishment when responding to contacts of interest during all-weather patrols.

Maximum Draft: 4.5 feet The maximum draft of 4.5 feet is necessary for ease of maneuverability in and around the protected assets.

Number of Crew: Two. At least one coxswain and one observer/lookout must be assigned to each boat for the duration of the patrol period. These personnel must be qualified in the operation of the security boat, and must be qualified with, and armed with personal protective weapons in accordance with SECNAVINST 5500.29C, DoDD 5210.56, as permitted by state and local regulations.

Required Cargo Capacity or Deck Space: Stowage space must be sufficient to accommodate at least four (including 2 spare) life vests, a flood light, a first-aid kit, a back board, and specialized tactical equipment, etc.

Propulsion System (e.g., Diesel inboard with outdrive, Diesel inboard with waterjet, or gasoline outboard) and why:

The propulsion system must be able to conduct multiple idle/sprint missions during each patrol period. Because of the limited operating area, propulsion systems must be capable of rapidly responding to a contact of interest (normally within the 200 yard operating zone) and rapidly reversing.

Speed 20kts. A minimum speed of 20kts is necessary to provide the capability to rapidly respond to contacts of interest or rapidly move out of the line of fire from shipboard responders in the event of a deadly engagement.

NAVSEA  
STANDARD ITEM

FY-24

ITEM NO: 009-73

DATE: 25 OCT 2022

CATEGORY: I

1. SCOPE:

1.1 Title: Shipboard Electrical/Electronic Cable Procedure; inspect, test, install, remove, and repair

2. REFERENCES:

2.1 Standard Items

2.2 MIL-STD-2003, Electric Plant Installation Standard Methods for Surface Ships and Submarines

2.3 SE000-01-IMB-010, Navy Installation and Maintenance Book (NIMB), Section IX, Installation Standards (Source CD: N0002400003)

2.4 MIL-STD-2042, Fiber Optic Cable Topology Installation Standard Methods for Naval Ships

2.5 S9086-KC-STM-010/CH-300, Electric Plant - General

2.6 MIL-STD-1310, Shipboard Bonding, Grounding, and Other Techniques for Electromagnetic Compatibility, Electromagnetic Pulse (EMP) Mitigation, and Safety

2.7 S9300-A6-GYD-010, Electrical Workmanship Inspection Guide for Surface Ships and Submarines

2.8 S9AA0-AB-GOS-010, General Specifications for Overhaul of Surface Ships (GSO)

2.9 SE000-01-IMB-010, Navy Installation and Maintenance Book (NIMB), Section VII, Industrial Electromagnetic Compatibility (IEMC) Work Process Instructions (Source CD: N0002400003)

2.10 IA PUB-5239/31, Information Assurance Shipboard Red/Black Installation Publication

2.11 CNSSAM TEMPEST/01-13, (U) RED/BLACK Installation Guidance

2.12 ANSI/TIA/EIA-568-B.2 – Commercial Building Telecommunications Cabling Standard – Part 2: Balanced Twisted-Pair Cabling Components

3. REQUIREMENTS:

3.1 Ensure only Qualified Personnel prepare electrical cable endings to receive connectors, assemble connector parts on the cable endings, attach the connectors to the cable endings, supervise, and inspect the execution of the process. (See 4.5 and 4.6)

3.1.1 Submit one legible copy, in hard copy or approved transferrable media, of the credentials of the Qualified Personnel accomplishing connector fabrication, Supervision, and QA Inspection to the SUPERVISOR prior to the start or continuation of work. Submit any change as it occurs.

3.2 Inspect existing affected cable installations and interferences within the first 25 percent of contract completion. Inspect for conformance in accordance with 2.2, and 2.4.

3.2.1 Submit one legible copy, in hard copy or approved transferrable media, of a report listing inspection results including cable installation conditions not in compliance with 2.2 and 2.4 to the SUPERVISOR, using Attachments A and B, within 4 days of completion of inspections. (See 4.7)

3.3 Accomplish a shipboard electrical/electronic cable test on affected cables.

3.3.1 Accomplish an insulation resistance test of each electric cable conductor using the appropriate direct current megger using Table 300-3-4 of 2.5 for guidance.

3.3.1.1 Disconnect low voltage equipment associated with circuits to be tested to prevent damage during tests.

3.3.1.2 Ensure the minimum acceptable readings of each cable conductor to ground and between conductors are:

Lighting Circuit	0.5 Megohm
Power Circuit	1.0 Megohm
Degaussing Circuit	0.1 Megohm
Interconnecting Control Circuit	1.0 Megohm
Interior Communication Circuit	0.2 Megohm
Sound Powered Telephone Circuit (with telephone disconnected)	0.05 Megohm
Multiconductor Cables (with circ mil less than 1700)	0.05 Megohm

3.3.1.3 Ensure the minimum acceptable reading of coaxial cable are in accordance with Section 2.8.3.3 of 2.3:

cable with Coax...	Length (feet)	Insulation resistance in megohms (To equal or exceed)
Polyethylene or polytetrafluorethylene (Teflon) dielectric	100 (or less)	40,000
	200	20,000
	500	8,000
	1,000	4,000
Synthetic rubber dielectric	Up to 1,000	1,000

cable with Coax...	Length (feet)	Insulation resistance in megohms (To equal or exceed)
Magnesium oxide dielectric	Up to 1,000	10,000
Dielectric material arranged in layers of conducting and non-conducting rubber	Up to 1,000	500

3.3.1.4 Discharge coaxial cable to ground following insulation resistance test.

3.3.2 Test each cable conductor for continuity and complete circuit. Ensure terminal connections are tight.

3.3.3 Test each cable for conductor continuity, complete circuit, all swept electrical parameters, and bandwidth per 2.12 using a SCAT 4465 cable tester. Ensure cable connectors are tight.

3.4 Install each new cable, cableway, penetration, sleeving, lug, and connector in accordance with 2.2, 2.3, 2.6 and referenced drawings, to support work required by the individual Work Items. (See 4.2.1)

3.4.1 Ensure new cable conforms to MIL-DTL-24643 (low smoke) and MIL-DTL-24640 (lightweight). New Radio Frequency (RF) cables must conform to MIL-DTL-17 (low smoke).

3.4.2 Use existing cableways and penetrations wherever possible.

3.4.3 Ensure penetrations are the correct size in accordance with 2.2.

3.4.4 Install new cable conductor identification sleeving conforming to SAE AS23053, Class One, white, marked with indelible ink. Mark in accordance with the referenced drawings and/or equipment technical manual.

3.4.5 Install new lugs of correct size and shape conforming to MIL-T-16366 or SAE-AS7928. Do not cut off strands of copper to reduce size of lead to fit lug. Use correct barrel and hole size.

3.4.6 Accomplish the requirements of 009-25 of 2.1 for conducting a local air hose test after the installation, removal or relocation of cables of each new and disturbed multi-cable transit device, multi-cable penetration, stuffing tube, kick pipe, and cable penetration of tightness boundaries.

3.4.7 Band disturbed cable in accordance with Part 4 of 2.2.

3.4.8 Bond and ground cable in accordance with 2.6.

3.4.9 Accomplish the requirements of 3.3 through 3.3.1.4 immediately prior to conductor or cable termination.

3.4.10 Accomplish requirement 3.3.2 immediately prior to conductor or cable termination except for cables conforming to MIL-DTL-24643/59 - 77.

3.4.11 Accomplish requirement 3.3.3 for cables conforming to MIL-DTL-24643/59 - 77 after cable termination.

3.4.12 Connect each cable using referenced drawings.

3.4.13 Install new cable identification tags in accordance with 2.2 and 2.3.

3.5 Disconnect and remove each cable to be replaced in its entirety. Record and retain electrical hook-up data. (See 4.2.7)

3.5.1 Accomplish the requirements of 3.4 through 3.4.11.

3.6 Identify, disconnect and isolate each cable to be pulled back, reused, rerouted, relocated, or repurposed. Record and retain electrical hook-up data. (See 4.2.2 through 4.2.5)

3.6.1 Inspect each cable end to be disconnected for correct conductor identification sleeving, including size, type, and legible lettering in accordance with referenced drawing. Ensure lugs are secured to leads and are of correct size and type, and the insulation is not damaged. Accept and reject criteria for lugs and sleeving for cables must be in accordance with Chapters 3 and 4 of 2.7.

3.6.2 Accomplish the requirements of 3.3 through 3.3.1.4 for disconnected cables.

3.6.3 Accomplish requirement 3.3.2 for disconnected cables except for cables conforming to MIL-DTL-24643/59 - 77.

3.6.4 Accomplish requirement 3.3.3 for disconnected cables conforming to MIL-DTL-24643/59 - 77.

3.6.5 Remove each cable from equipment and pull back to predetermined locations. Coil each cable and secure to prevent damage. Protect disconnected connectors and wiring from the industrial environment and weather.

3.6.6 Accomplish the requirements of 3.4.2 through 3.4.11. Use retained electrical hook-up data.

3.7 Identify, disconnect, isolate and remove each cable designated for removal. (See 4.2.6)

3.7.1 Blank each bulkhead, deck penetration, and multi-cable transit device from which cable was removed and which will not be reused, in accordance with Part 3 of 2.2.

3.7.2 Blank each unused hole in equipment, in accordance with 2.2.

3.7.3 Remove unused hangers from which cable was removed and which will not be reused, in accordance with Section 070a of 2.8.



2.2. 3.7.4 Install new banding for cableways affected by cable removals, in accordance with Part 4 of

3.7.5 Accomplish the requirements of 3.4.6.

3.8 Weatherproof and seal connectors exposed to the weather in accordance with 2.9.

3.9 Remove, install, and relocate cables which are part of the secure electrical information processing systems or are located within a secure processing space in accordance with 2.10 and 2.11.

3.10 Accomplish the requirements of 009-32 of 2.1 for each new and disturbed surface.

3.11 Submit one legible copy, in hard copy or approved transferrable media, of a report listing results of the requirements of 3.4.9 and 3.6.2, including circuit numbers, lead numbers, and readings obtained, to the SUPERVISOR within 3 days of completion of tests.

#### 4. NOTES:

4.1 The requirements in this Standard Item apply to installation, repair, disconnect, connect, removal, relocation, test, and inspection of electrical/electronic cables affected by the work required by individual Work Items on Naval surface ships and submarines and personnel supporting these tasks. This Standard Item applies to the following cable usages; new, removed, replaced, pulled back, reused, rerouted and repurposed.

#### 4.2 Cable Definitions

4.2.1 New Cable – a cable not previously installed.

4.2.2 Pulled Back Cable – a cable disconnected and physically removed from a wireway, conduit, or cableway to protect the cable from industrial use.

4.2.3 Reused Cable – a cable disconnected from the equipment to facilitate equipment removal.

4.2.4 Rerouted Cable – a cable disconnected from equipment and physically moved to a new wireway, conduit, or cableway and then reconnected in the new location to the same equipment.

4.2.5 Repurposed Cable – a cable with termination points changed.

4.2.6 Removed Cable – a cable disconnected from equipment and physically removed in its entirety and not being replaced.

4.2.7 Replaced Cable – a cable disconnected from equipment and physically removed to install with a new cable.

4.3 Cable installations consist of cable, banding, boxes, equipment, penetrations, cableways, hangers, cable separation and connection(s) and associated components.

4.4 Electrical connector fabrication is the preparation of cable endings to receive multi-pin connectors, coaxial connectors, and securing connectors to cables.

4.5 A Qualified Person is defined as a person who has successfully completed connector fabrication training and meets the qualification requirements stated below.

4.5.1 Emphasizes the importance of connector fabrication to the performance and long-term reliability of shipboard systems.

4.5.2 Uses 2.2, 2.3, and 2.7 for basic instructional material supplemented by connector manufacturer's instructional material as desired.

4.5.3 Requires classroom lecture, study, and demonstration of each topic in Appendix A of Part 5 of 2.2.

4.5.4 Requires individual student practice in the use of specified tools and performance of connector fabrication techniques and procedures described in Appendices B through H of Part 5 of 2.2 and Paragraph 2-20.2 of 2.3.

4.5.5 Requires a minimum of 32 hours of combined classroom lecture and laboratory practice in the type of connectors to be fabricated.

4.6 Connector fabrication qualifications consist of:

4.6.1 Connector Fabricator Qualification requirement: Successful completion of the training course required in 4.5.5 followed by successful completion of 40 hours on-the-job training under the tutelage of a qualified connector fabricator or a qualified connector fabrication supervisor in the type of connectors to be fabricated.

4.6.2 Connector Fabrication Supervisor Qualification requirement: Successful completion of the classroom training required in 4.5.5 plus be the incumbent of a supervisory electrical or electronic mechanic position.

4.6.3 Connector Fabrication Quality Assurance Inspector Qualification requirement: Successful completion of the classroom training required in 4.5.5 plus be the incumbent of a quality assurance specialist or inspector position.

4.7 Attachment B is provided as an aid to completion of Electrical Cableway Inspection Form.

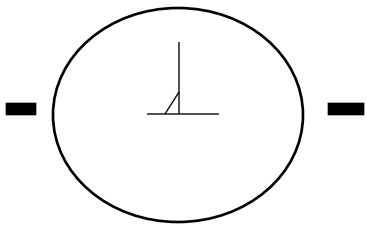

ATTACHMENT A  
ELECTRICAL CABLEWAY INSPECTION FORM

DATE \_\_\_\_\_ HULL NUMBER \_\_\_\_\_

INSPECTED BY \_\_\_\_\_ INSPECTING ORGANIZATION \_\_\_\_\_

SER #	COMPT	DECK	FRAME	P/S	POS	CABLE CIRCUIT DESIG	CABLE TYPE	*CAT	*NAVSEA DWG NO.	EQUIPMENT
DESCRIPTION										
DESCRIPTION										
DESCRIPTION										
DESCRIPTION										

\* SEE ATTACHMENT B FOR "CATEGORY" GUIDANCE

ATTACHMENT B

INSPECTION CRITERIA FOR ELECTRICAL CABLES AND CABLEWAYS

CATEGORY 1 - Immediate Hazard

CATEGORY 2 - Potential Hazard

CATEGORY 3 - Non-Hazardous

ITEM	CRITERIA	CATEGORY	
<b>I. CABLES</b>			
	<b>A. Installation</b>		
	1.	Minimum bend radius exceeded, causing visual damage to cable.	1
	2.	Minimum bend radius exceeded; No visual cable damage, cable rings out and meggers satisfactorily.	3
	3.	Equipment connector supporting weight of cable (more than 32 inches of cable from last support to end use equipment). (18 inches from shock mounted motors).	1
	4.	Cables run on or near hot objects (steam or exhaust pipes, griddles, ovens, etc).	1
	5.	Cable run outside of hangers.	3
	6.	Lack of slack at expansion joints.	2
	7.	Excess slack between hangers. (Minimum distance of 6 feet 4 inches between deck and cables.)	3
	8.	Excess cable slack stored in wireway.	3
	<b>B. Damaged</b>		
	1.	Bulging, bubbling or discoloration of cable jacket (evidence of overloading, overheating or hot spots.)	1
	2.	Bulging, bubbling or discolored cable jacket; but cable rings out and meggers satisfactorily.	2
	3.	Cable chafed or cut through outer jacket only.	2
	4.	Cable chafed or cut through, inner wire insulation damage.	1
	5.	Cable pulled out of equipment/junction box penetrations and leads exposed	1
	6.	Armored and unarmored cables in contact at an oblique angle causing chafing of unarmored jacket.	2

ITEM		CRITERIA	CATEGORY
	7.	Fiber cable chafed or cut beyond the cable outer jacket to the Kevlar strength members	1
C. Dead-ended			
	1.	Cable dead-ended, not end sealed and labeled (serialized) properly at both ends.	1
	2.	Cable for future use not properly sealed on both ends and labeled at both ends for the specific use.	1
	3.	Cable dead-ended, end sealed and labeled (serialized) properly.	3
D. Spliced			
	1.	Improper materials/methods used for splicing, or evidence of loose joints.	1
	2.	Splice located in bend of cable.	2
II. BANDING			
A. All Cable Runs			
	1.	Banding cuts cable outer jacket (banding too tight).	1
	2.	Banding compressing outer jacket (banding too tight but not cutting jacket).	3
	3.	Plastic tie wraps used in place of banding straps (metal banding strap required).	2
	4.	Cables secured to hanger with bailing wire or rope.	1
	5.	Bands cut and left in wireway.	2
	6.	Channel rubber not installed where required.	2
B. Horizontal Cable Runs			
	1.	Banding not installed at breakout hangers before and after penetrations or at change of direction of wireway.	2
C. Vertical Cable Runs			
	1.	No banding or loose banding (banding required on every hanger).	2
III.			
A. Cableways			

ITEM		CRITERIA	CATEGORY
	1.	Cable hangers or hardware cutting into the cable jacket.	1
	2.	Improper hanger spacing (Cable hangers are required at least every 32 inches except that hangers for multiple tier overhead aluminum decks must be spaced every 16 inches).	2
	3.	Inadequate cableway support (hangers, hardware, tiers, or cable straps missing) or welds cracked.	2
	4.	Overload/Overcrowded cable hangers.	3
	5.	Maximum no. of tiers exceeded.	3
	6.	Inadequate fastener length.	3
	7.	One-half inch clearance between cable run and hangers above or structure not provided.	2
<b>IV. EQUIPMENT</b>			
	<b>A. Covers</b>		
	1.	Junction box or equipment covers loose or missing.	1
	<b>B. Mounting</b>		
	1.	Cable supporting the weight of equipment (power junction boxes, lighting fixtures switch boxes, etc.)	1
	2.	Missing loose or improperly installed mounting hardware on equipment.	2
	<b>C. Cable Entrance</b>		
	1.	Watertight penetrators not utilized for entrance to watertight equipment enclosures.	1
	2.	Drip loops, drip shields plastic sealer or bottom penetration not utilized for entrance to non-watertight drip proof equipment.	1
	3.	Cable can be moved in and out of tube. Improperly packed or not packed.	1
	4.	Nylon tube base loose in enclosure. (O-ring missing)	1
<b>V. DECK/BULKHEAD PENETRATION</b>			
	<b>A. Non-watertight Deck or Bulkhead Cable Penetration</b>		
	1.	No plastic sealer around cables through collars where required.	1

ITEM		CRITERIA	CATEGORY
	2.	Chafing protection not installed at non-watertight deck or bulkhead cableway penetrations.	2
	3.	Chafing ring overloaded.	3
	4.	Inadequate chafing protection and damage evidence.	1
<b>B. Watertight Deck or Bulkhead Cable Penetration</b>			
	1.	No plastic sealer around cable at stuffing tubes which are exposed to the weather. Note: If plastic sealer is installed at locations other than those exposed to the weather, it is not required to be removed.	2
	2.	Stuffing tube or kickpipe not utilized (cable installed without tube).	1
	3.	Unused stuffing tube or kickpipe not plugged.	1
	4.	Stuffing tube or kickpipe assembly incomplete (missing gland nut, packing, or pipe connector).	1
	5.	Stuffing tube assembly incorrect (improper packing).	2
	6.	Stuffing tube or kickpipe too large for size of cable.	3
	7.	Multiple cables in a single stuffing tube or kickpipe.	2
	8.	Stuffing tube or kickpipe damaged to point where complete assembly not possible (cracked welds, damaged threads, out-of-round, etc.) if firestop material is installed.	2
<b>C. Watertight Deck or Bulkhead Penetrations Utilizing Multiple Cable Penetration</b>			
	1.	Insert blocks, compression bolts or filler blocks missing.	1
	2.	Improper size blocks used for size cable installed violating watertight integrity.	2
	3.	Incorrect type of RTV used to seal armored cable through MCP blocks.	1
	4.	RISE type MCP not properly sealed.	1

NAVSEA  
STANDARD ITEM

FY-24

ITEM NO: 009-74  
DATE: 25 OCT 2022  
CATEGORY: I

1. SCOPE:

1.1 Title: Occupational, Safety and Health Plan; accomplish

2. REFERENCES:

2.1 Standard Items

2.2 29 CFR Part 1915, Occupational Safety and Health Standards for Shipyard Employment

2.3 29 CFR Part 1910.67, Vehicle-Mounted Elevating and Rotating Work Platforms

2.4 Safe Work Practices for Marine Hanging Staging: An OSHA Guidance Document, April 2005

2.5 Joint Fleet Maintenance Manual (JFMM)

2.6 S0400-AD-URM-010/TUM, Tag-Out User's Manual

2.7 S9086-KC-STM-010/CH-300, Electric Plant – General

2.8 29 CFR Part 1904.7, Recording and Reporting Occupational Injuries and Illness, General Recording Criteria

3. REQUIREMENTS:

3.1 Establish, document, implement, and maintain a written Occupational Safety and Health Plan appropriate for the work to be accomplished. Provide a copy of the Occupational Safety and Health Plan to the SUPERVISOR upon request. At a minimum, the Occupational Safety and Health Plan must include the following elements:

3.1.1 Method(s) of communicating potential hazards, prior to the start of any task, to contractor's employees, subcontractor employees, and other potentially affected personnel.

3.1.1.1 Hazards to be addressed must include but not be limited to emergency evacuation and muster policy, confined space, and energy control.



3.1.2 A process for performing a Job Safety Analysis/Job Hazard Analysis (JSA/JHA) for:

3.1.2.1 Processes and equipment new to the worksite.

3.1.2.2 Existing processes and equipment that have been involved in mishaps or near misses.

3.1.2.3 Maintain a copy of each JSA/JHA which must be available for review by the SUPERVISOR upon request.

3.1.3 A process for identification, communication, abatement, and prevention of unsafe conditions and work practices.

3.1.4 Method(s) to account for employees and subcontractors working in isolated areas, e.g. Confined spaces.

3.1.5 Method(s) to ensure work areas and walkways are adequately illuminated.

3.1.6 Method(s) to establish and maintain good housekeeping practices.

3.1.7 Method(s) to ensure that medical services and first aid are readily accessible.

3.1.8 Method(s) to provide adequate and readily accessible sanitation facilities.

3.1.9 A process for notifying the Quarterdeck and initiating emergency response.

3.2 Update the Safety Plan as circumstances warrant or at the request of the SUPERVISOR.

3.3 Provide a Safety Point of Contact to the SUPERVISOR before each project.

3.4 Provide appropriate Personal Protective Equipment (PPE) for employees and monitor utilization in accordance with 2.2.

3.5 Mark or tag material and equipment brought aboard naval facilities and vessels. Marking or tags must endure the repair process, and must stay attached and/or be readable until the material or equipment is dismantled.

3.5.1 Marking/tags must display the company name, point of contact, phone number, item description and contents.

3.6 Provide the SUPERVISOR a complete list of subcontractors (e.g., company name) hired by the contractor prior to subcontractor(s) commencing work aboard naval facilities or vessels.

3.6.1 Contractor must monitor, inspect, oversee, and abate hazardous or deficient conditions related to the conduct and work practices of subcontractor(s).

3.7 Ensure Material Handling Equipment (MHE) is operated and maintained in accordance with 2.2 and manufacturer's specifications. Ensure Aerial Work Platforms (AWP) are operated and maintained in accordance with 2.3 and manufacturer's specifications.

3.7.1 Ensure operators of MHE and AWP meet applicable training and licensing requirements and provide documentation to the SUPERVISOR upon request.

3.7.2 Ensure operators conduct a daily operational check of the MHE or AWP before use.

3.7.2.1 Maintain copies of the daily operational checks for the duration of the performance period of the prime contract and provide copies to the SUPERVISOR upon request.

3.8 Each employee must have a flashlight or other adequate light source onboard a navy vessel.

3.9 Notify personnel of lifting operations by audible alerts during crane operations (e.g., whistles or horns). Audible alerts must be utilized throughout the lifting evolution.

3.10 Comply with the fall protection requirements of 2.2.

3.11 Scaffolding must be built, maintained, and dismantled in accordance with 2.4 and manufacturer's specifications or under the direction of a Professional Engineer.

3.11.1 Provide manufacturer's specifications to the SUPERVISOR upon request.

3.11.2 Tag all scaffolding. Tags must endure the repair process, and must stay attached and be readable.

3.11.2.1 Tags must display the stage of completion, scaffold load capacity, and availability for use.

3.11.3 Erect scaffolding so that a swing gate is installed at each working level accessed by a ladder.

3.11.4 Ensure marine hanging scaffolding meets the guidance provided in 2.4.

3.11.5 When there is a danger of tools, materials, or equipment falling from a scaffold and striking employees below during the erection, dismantling, or altering of scaffolding, the area below the scaffold to which objects can fall must be barricaded and adequately identified with signs and danger tape. Employees not involved with the scaffolding operation must not be permitted to enter the hazard area.

3.12 Ensure protective measures are taken in accordance with 2.2 before creating a deck opening or an unguarded edge.

3.12.1 Deck openings and unguarded edges must not be left unprotected for any amount of time.

3.13 Notify the SUPERVISOR and accomplish the requirements of 2.2, Volume IV, Chapter 10 of 2.5, and 2.6 prior to working aloft.

3.13.1 Accomplish the requirements of the vessel's work aloft instruction and utilize the vessel's working aloft request form.

3.13.1.1 The vessel's working aloft request form must be routed in accordance with the ship's aloft instruction for permission for working over the side or in aloft zones. Do not enter aloft zones or be suspended over the side by a crane without first obtaining written permission from the Officer of the Deck (OOD) in the form of working aloft request form.

3.13.1.2 Verify that the working aloft request form is active prior to going aloft each time.

3.13.2 Provide and use personal fall arrest system (PFAS), working lanyard, and climber safety device when going aloft where a climber safety rail is installed. If a climber safety rail is not installed, use a double lanyard configuration.

3.13.3 In the absence of a properly guarded work platform, position a safety observer on deck near the work being performed. The safety observer must keep the deck area beneath the work aloft free of unnecessary personnel.

3.13.4 In case of an emergency, the safety observer must notify the Quarterdeck or emergency services.

3.14 Accomplish safety precautions as specified in 2.7 for work on electrical/electronic circuits and equipment.

3.14.1 Obtain written authorization from the ship's Commanding Officer before testing or entering components which are energized at a value greater than 30 volts.

3.15 Notify the vessels Quarterdeck and the Supervisor immediately by verbal means of each incident (accident causing damage to vessel, injury meeting the requirements of Ref 2.8, flooding, and electric shock) which occurred, or is occurring on the vessel, dry dock where a naval vessel is docked or a pier/berth where the vessel is moored.

3.15.1 Secure and preserve the scene until released by the SUPERVISOR.

3.15.2 Submit one legible copy, in approved transferrable media, of a formal written report, Attachment A, of the incident to the SUPERVISOR within one day of each accident requiring medical treatment, each electrical shock, or any incident when requested by the SUPERVISOR. Provide daily updates within one day upon request by the SUPERVISOR, until the final report is submitted. The written report must contain the name of each injured person, date and time of incident, extent of each personal injury or property damage, contractor/subcontractor name, Job Order/Work Item Number, type of incident, location of event (ship name and hull number, space, compartment), a brief description of the event including occurrences leading up to the incident, equipment involved, Contract Number, witness and/or individuals involved, short term and long term corrective action, and root cause analysis.

3.16 Repair and maintenance employees working aboard vessels, dry docks and piers must have a valid 10 hour OSHA Maritime Shipyard Employment Course or NAVSEA-approved equivalent completion card within 60 days of employment.

3.16.1 Submit one legible copy, in hard copy or approved transferrable media, of a report listing employees who have completed training required by 3.16 to the SUPERVISOR upon request.

3.16.2 The authorized maritime trainer must have successfully completed the OSHA 5400 trainer course in occupational safety and health standards for the maritime industry. The authorized maritime trainer must have a current OSHA Training Institute ID number and must follow the OSHA outreach training program guidelines.

3.16.3 Maintain current copies of the training documents required by the guidelines for reference by the SUPERVISOR. Submit one legible copy in approved transferrable media when requested by the SUPERVISOR.

3.17 The use of tobacco products (cigarettes, cigars, smokeless tobacco, electronic cigarettes, and electronic nicotine delivery systems) is prohibited onboard vessels, adjacent piers and dry docks, except in designated areas.

3.18 Food and beverages (excluding water and “hydration supplements,” e.g., Gatorade) must not be permitted aboard vessels, except in areas designated by the SUPERVISOR.

3.19 Property taken onboard, such as bags and tool boxes, must be identified to include organization name, employee name and badge number.

3.20 Label compressed gas cylinders or cylinder storage racks with company name or unique identifier.

- 3. 20.1 Secure all compressed gas cylinders in a cylinder rack.
- 3. 20.2 Compressed gas cylinders must not be secured to pier or vessel structures.
- 3. 20.3 Secure all compressed gas cylinders for transportation by pallet or cylinder rack.

3.21 Submit a written request to use Ship's Force services (e.g., air, water and electrical power). Request must include rationale for deviation, duration of use, and type and description of equipment that will be utilizing ship's services.

3.21.1 Submit one legible copy, in approved transferrable media, of each request to the SUPERVISOR.

3.22 Comply with the requirements of 2.2 and 2.10 while operating a crane, multi-purpose machine, and material handling equipment that may be used in a crane-like application to lift a suspended load.

3.22.1 Report immediately to the SUPERVISOR, crane, multi-purpose machine, and material handling equipment that may be used in a crane-like application accidents on the vessel, in the dry dock or adjacent pier while at a non-government facility.

#### 4. NOTES:

4.1 The term "medical treatment" is defined in 2.8.

4.2 Requests for deviations/waivers of training requirements will only be approved by NAVSEA and on a case-by-case basis. This includes equivalent training for foreign nationals.

4.3 The term "repair and maintenance employee" is defined as one whose employment relates to or is in conjunction with ship repairing, shipbuilding, or shipbreaking work, including, but not restricted to, inspection, testing, and employment as a fire watch. This excludes employees who provide incidental services that do not influence shipyard employment such as delivery services.

4.4 A "quick disconnect" is a coupling or connecting device/system designed to permit easy and immediate separation of lines without the use of tools and to ensure the contents do not escape.

4.5 Cards that have an expiration date after April 1, 2019 are valid.

4.6 OSHA 5400 trainers meet the requirement of 3.16.

4.7 When a Fact Finding Report is directed in accordance 009-120 of 2.1, complete initial submission of Attachment A as directed by this Standard Item, report corrective action and root cause analysis in accordance with 009-120 of 2.1.

**ATTACHMENT A**  
**FOR OFFICIAL USE ONLY**

<b>INCIDENT REPORT</b>		
Report #		
<b>INITIAL REPORT</b> <input type="checkbox"/>	<b>REQUESTED UPDATE</b> <input type="checkbox"/>	<b>FINAL REPORT</b> <input type="checkbox"/>

<u>TYPE OF INCIDENT:</u>	
<u>NAME(S) OF INJURED (if applicable):</u>	
<u>INCIDENT DATE:</u>	<u>COMPANY:</u>
<u>TIME:</u>	<u>SUPERVISOR:</u>
<u>LOCATION OF INCIDENT:</u>	<u>TYPE OF INJURY OR FIRE:</u>
<u>CAUSE OF INCIDENT:</u>	<u>EQUIPMENT INVOLVED:</u>
<u>WORK ITEM NUMBER:</u>	<u>CONTRACT NUMBER:</u>

**WITNESS AND/OR INDIVIDUALS INVOLVED**

NAME(S)	DEPT.	COMPANY

**DESCRIPTION OF INCIDENT**

--

**DISPOSITION OF INJURED (if applicable)**

--

**IMMEDIATE CORRECTIVE ACTION**

--

**ATTACHMENT A**  
**FOR OFFICIAL USE ONLY**

INVESTIGATED BY (NAME):	TITLE:
SIGNATURE OF INVESTIGATOR:	DATE:
INCIDENT REPORT	
Report #	

LONG TERM CORRECTIVE ACTION

ROOT CAUSE ANALYSIS

**ATTACHMENT A**  
**FOR OFFICIAL USE ONLY**

INVESTIGATED BY (NAME):	TITLE:
SIGNATURE OF INVESTIGATOR:	DATE:

Incident Report Instructions

REPORT NUMBER- Unique tracking number created by contractor

TYPE OF INCIDENT- Injury, fire or near miss

NAME(S) OF INJURED- Self Explanatory

INCIDENT DATE: - Self Explanatory

TIME: - Self Explanatory

COMPANY: - Prime and subcontractors involved

SUPERVISOR – Supervisor of employee(s) involved

LOCATION OF INCIDENT: - Base/Yard, Ship name and hull number, space number and compartment name

TYPE OF INJURY OR FIRE – i.e. broken arm, laceration to head or Class A, B, C fires, smoldering

CAUSE OF INJURY – i.e. Equipment failure, PPE, process



**ATTACHMENT A**  
**FOR OFFICIAL USE ONLY**

EQUIPMENT INVOLVED – Equipment working on and equipment being used to cause incident

WORK ITEM NUMBER – Work Item being accomplished when incident occurred

CONTRACT NUMBER: - Contract Number assigned by government agency i.e. RMC, Alteration Installation Team (AIT) Sponsor.

WITNESS AND/OR INDIVIDUALS INVOLVED – Name, company of witnesses and or individuals involved with the incident.

DESCRIPTION OF INCIDENT OR NEAR MISS – Short description of events leading up to incident and extent of injuries and or damage to equipment.

DISPOSITION OF INJURED – i.e. Transported to hospital via ambulance or POV, transported to clinic, released from hospital, name of hospital or clinic, limited duty or loss time (if known).

IMMEDIATE CORRECTIVE ACTION – i.e. Scene/space secured, ship notified (who and when), RMC notified (who and when) clean up of blood, equipment secured fire debris cleaned up.

INVESTIGATED BY – Self Explanatory.

TITLE – Self Explanatory.

SIGNATURE OF INVESTIGATOR – Self Explanatory.

DATE – Self Explanatory.

LONG TERM CORRECTIVE ACTION – What action(s) were taken so that incident does not reoccur, i.e. training, safety stand down or process/policy change.

ROOT CAUSE ANALYSIS – Process by which you will identify the cause or contributing factors of the incident.

Note: Attach additional information as necessary.

NAVSEA  
STANDARD ITEM

FY-24

ITEM NO: 009-75  
DATE: 25 OCT 2022  
CATEGORY: II

1. SCOPE:

1.1 Title: Circuit Breaker; repair

2. REFERENCES:

2.1 Equipment Technical Manual

3. REQUIREMENTS:

3.1 Identify and pull back associated cables and wiring. Mechanically remove each circuit breaker, using 2.1 for guidance.

3.1.1 Matchmark, identify and retain mounting hardware and fasteners.

3.1.2 Protect exposed terminal connections and internal switchboard parts from foreign material including dirt and debris, and from damage.

3.1.2.1 Each phase must be isolated and protected from other phases.

3.2 Disassemble each circuit breaker, using 2.1 for guidance.

3.2.1 Inspect and test electrical and mechanical components, assemblies, subassemblies, internal circuitry, and hardware to design characteristics and determine missing and defective components, circuitry, and hardware in accordance with 2.1.

3.2.1.1 Acceptance criteria for silver contacts is that wear must be less than 50 percent of original thickness after dressing, contacts must have no evidence of copper migration, and must have no irregular, burnt, or pitted interface after dressing.

3.2.1.2 Acceptance criteria for non-silver contacts is that, after dressing, wear must be less than 10 percent of original thickness and contacts must have no irregular, burnt, or pitted interface after dressing.

3.2.2 Test internal wiring, coils, and transformers for open and short circuits and 500 volt megger insulation resistance to ground. Record readings. Minimum acceptable resistance to ground must be one megohm.

3.2.3 Shop test and inspect each motor operator and motor in accordance with 2.1.

3.2.4 Test and inspect molded and insulation parts in accordance with the following criteria:

3.2.4.1 Phase-to-phase dielectric strength 2,000 volts minimum.

3.2.4.2 Surface burn marks and hairline cracks are acceptable but must not deteriorate the mold surface or impair physical strength. Cracks are not permitted in wall section between phase and a ground plane when there is a conducting part in contact with the wall section. Cracks should not exceed 0.75 inch in length, and in no case should be greater than 50 percent of the length of the surface in which the crack appears.

3.2.4.3 Surface cracks should not exceed 1.5 inches in length, and in no case should be greater than 50 percent of the length of the surface in which the crack appears.

3.2.5 Submit one legible copy, in approved transferrable media, of a report listing test and inspection results and missing and defective components, circuitry and hardware to the SUPERVISOR.

3.3 Remove defective and install new electrical and mechanical components, assemblies, subassemblies, internal circuitry, and hardware. Install new electrical and mechanical components, assemblies, subassemblies, internal circuitry, and hardware where missing. New material must conform to the requirements of 2.1 and must be obtained from the Federal Stock System or the Original Equipment Manufacturer (OEM), except for non-restricted parts.

3.3.1 Clean each component free of dirt, lubricants, and other foreign matter.

3.3.1.1 Steam cleaning of circuit breakers is not authorized.

3.3.2 Resilver previously silver plated contacts in accordance with ASTM B 700.

3.3.3 Dress, burnish, adjust, and align arcing and main contacts (contacts that experience arcing in functional duty) in accordance with 2.1.

3.3.4 Replace existing cadmium-plated parts with zinc in accordance with ASTM A 153.

3.3.5 Dip and bake taped insulated coils and open transformers in varnish conforming to MIL-I-24092, Class 155.

3.3.5.1 Dip and bake insulated coils and open transformers in Dolph Varnish 1105, Epoxylite Esterlite 605, or Schenectady International Isolite 862M varnish in localities where MIL-I-24092 varnish does not meet state and local air pollution control district standards.

3.3.6 Remove defective existing and install new coil and transformer leads. Install new coil and transformer leads in place of those identified to be missing.

3.3.7 Repair defective connections.

3.3.8 Free-up and adjust moving parts and latching mechanisms.

3.3.9 Lubricate the current-carrying parts (except for interrupting contacts) and sliding joints with lubricant conforming to MIL-DTL-87177, Type I, Grade B. Lubricate mechanical pivots, excluding latch roller face components, with high performance multi-purpose grease conforming to MIL-PRF-24508.

3.3.9.1 Apply new lubricant sparingly and wipe off excess.

3.4 Assemble each circuit breaker and accomplish adjustments and settings in accordance with 2.1. Record readings.

3.4.1 Align and true each set of stationary and movable contacts to the manufacturer's specifications. Record readings.

3.4.2 Accomplish millivolt drop test to each set of contacts in accordance with 2.1 or Original Equipment Manufacturer (OEM) requirements. Record readings.

3.5 Test, calibrate, adjust, and certify the trip units of each circuit breaker for time delay and instantaneous trip settings in accordance with 2.1. Record readings.

3.5.1 Accomplish a heat run test for repaired type ACB and AQB circuit breakers.

3.5.1.1 Connect each ACB type circuit breaker to a test set and apply rated current to each individual phase of the circuit breaker for 30 minutes. After 5 minutes, measure the voltage across the line to load contacts of each pole and calculate the contact impedance. Satisfactory impedance: 1,600-4,000 ampere ACB's, below 225 microhms; 600-900 ampere ACB's, below 1,050 microhms.

3.5.1.2 Connect each AQB-type molded case circuit breaker to a test set and apply rated current to each phase simultaneously for one hour. The AQB must not trip within that hour.

3.5.2 Attach a calibration label to the face of each circuit breaker denoting the name and location of the calibration facility and date of calibration. In the event there is insufficient room on the face of the circuit breaker, attach the calibration label to the right hand side of the breaker as viewed from the front.

3.6 Submit one legible copy, in approved transferrable media, of a report listing results of the requirements of 3.4, 3.5, and a list of new components, assemblies, subassemblies, internal circuitry, and hardware installed to the SUPERVISOR.

3.7 Install and connect each circuit breaker, using retained mounting hardware and fasteners.

(V)(G) "OPERATIONAL TEST"

3.8 Accomplish final adjustments and test operate each circuit breaker, including control and safety devices.

3.8.1 Close and trip each circuit breaker electrically from local and remote stations. Three consecutive successful times required.

3.8.1.1 Ensure generator heater interlock is de-energized by the generator circuit breaker.

3.8.2 Repeat the requirements of 3.8.1 manually.

4. NOTES:

4.1 Equipment technical manual will be listed in the invoking Work Item.

4.2 Repair and overhaul will be accomplished by the Navy Designated Overhaul Point (DOP) at Puget Sound Naval Shipyard, the OEM, or a commercial repair facility that has demonstrated to the SUPERVISOR the capability to perform the work. Capability to perform circuit breaker overhaul and repair work includes having the facilities, trained mechanics, and access to the OEM's qualified parts and repair procedures. Use of non-qualified restricted parts violates the integrity of the circuit breaker, nullifying the breakers prior qualification under the QPL process. Restricted parts must be obtained from the OEM either directly or via (if available) the Federal stock system. If a restricted part is replaced with an unqualified part, the qualification of the particular circuit breaker is revoked until the full set of QPL required tests are repeated and submitted to NAVSEA for approval.

4.3 Non-restricted parts are defined as nuts, bolts, screws, washers, lockwashers, cotter pins, O-rings, indicator lights, and indicator light globes (colored and clear) only.

4.4 The following ACB circuit breakers listed by manufacturer contain non-friable asbestos arc chutes:

4.4.1 SPD, ITE, ITE/Gould: 640R, 900RC, 901R, 1600R, 1600HR, 1600HRC, 2000HR, 2000RC (450V), 2601R, 2801R, 3200HR, 4000HR.

4.4.2 General Electric: all types.

4.4.3 Westinghouse: All DBN types.

NAVSEA  
STANDARD ITEM

FY-24

ITEM NO: 009-76  
DATE: 25 OCT 2022  
CATEGORY: II

1. SCOPE:

1.1 Title: Waveguide and Rigid Coaxial Lay-Up; accomplish

2. REFERENCES:

2.1 SE000-01-IMB-010, Navy Installation and Maintenance Book (NIMB), Section IX, Installation Standards (Source CD: N0002400003)

3. REQUIREMENTS:

3.1 Disconnect each dry air pressure line at last mechanical joint as designated by the SUPERVISOR and connect temporary nitrogen or dry air lay-up control/monitor panels and associated equipment to ship's dry air panel.

3.1.1 Where lay-up conditions permit, ensure temporary nitrogen or dry air lay-up control/monitor panels are operational for continuous monitoring of temporary nitrogen or dry air in the equipment space(s).

3.1.1.1 Use of ship's dry air control/monitor panels may be an option, but only when lay-up conditions permit, and verified that equipment's dry air control/monitor panels are operational for continuous monitoring of temporary dry air in the equipment space(s).

3.2 Accomplish uninterrupted nitrogen or dry air lay-up for each waveguide and rigid coaxial cable in accordance with Paragraph 5-2.7 of 2.1.

3.2.1 Do not connect unregulated pressurized air to equipment sub-assemblies or components. Ensure that each temporary dry air pressure source is connected to prevent equipment damage due to over-pressurization. No pressurization must be supplied to waveguide in excess of the normal operating pressures specified for that equipment.

3.2.2 Ensure temporary dry air meets the requirements of Paragraph 5-1.14 and 5-1.15 of 2.1, and the following:

3.2.2.1 Dew Point: Minus 40 degrees Fahrenheit at 80 PSIG.

3.2.2.2 Quality of Air: Filtered to remove all particulate matter greater than one micrometer and filtered for a total amount of contamination (including oil contaminants) not to exceed one part per million by weight.

3.2.3 Pressurize each line as specified for that equipment.

3.2.3.1 Where specific lay-up instructions are not available, pressurize those lines to 3 PSIG.

3.2.3.2 Install relief valve downstream of temporary source, setting relief pressure at 5 PSIG.

3.2.4 Identify leaks in accordance with Paragraph 5-2.7.2 and 5-2.7.3 of 2.1.

3.2.4.1 Submit one legible copy, in approved transferrable media, of a report listing results of the requirements of 3.2.4 to the SUPERVISOR.

3.3 Remove temporary pressurization when directed by the SUPERVISOR. If any ship's dry air control/monitor panels were utilized, restore each and verify operational.

3.3.1 Connect each dry air pressure line disconnected in 3.1.

3.3.2 Purge and pressurize in accordance with Paragraph 5-2.7 of 2.1.

4. NOTES:

4.1 None.

NAVSEA  
STANDARD ITEM

FY-24

ITEM NO: 009-77  
DATE: 25 OCT 2022  
CATEGORY: II

1. SCOPE:

1.1 Title: Cofferdam Installation; accomplish

2. REFERENCES:

2.1 Standard Items

2.2 S0600-AA-PRO-160/CH-16, Underwater Ship Husbandry Manual, Cofferdams

3. REQUIREMENTS:

3.1 Maintain watertight integrity to a level 4 feet above the maximum calculated draft, including but not limited to the following operations: access openings, hull plating replacement, welding to the hull when pre-heating is required, modifications or repairs to damage or deterioration that will degrade watertight integrity or stability, or piping and mechanical repairs that are expected to result in less than double-valve protection.

3.2 Accomplishment of a Process Control Procedure (PCP) to support installation of a cofferdam (e.g., plug, patch, dry chamber, stern tube seal) must be in accordance with NAVSEA Standard Items (See Note 4.3) and Attachment B, include the following:

3.2.1 Include the Operational Checklist, Table 16-9 of 2.2, in the PCP.

3.2.2 Prior to the start of the PCP, any time the installed cofferdam will serve as the only barrier to the sea (single valve protection), ensure Ship's Commanding Officer sign-off via the SUPERVISOR, as required by Paragraph 16-4.7.1.5 (plugs), or Paragraph 16-5.2.10 (patches), or Paragraph 16-6.6.10 (dry chambers), or Paragraph 16-7.6.5 (stern tube seals) of 2.2. (See NOTE 4.4)

3.2.2.1 The first page of the PCP must be stamped SINGLE VALVE PROTECTION, at the top, in minimum one-half inch letters.

3.2.2.2 Attachment A must be used to document single valve isolation signatures.

3.3 Prior to the start of the PCP, submit one legible copy, in approved transferrable media, of Ship's Force notification in accordance with Paragraph 16-4.7.1.4 (plugs), or Paragraph 16-5.2.9 (patches), or Paragraph 16-6.6.10 (dry chambers), or Paragraphs 16-7.6.5 and 16-7.6.8 (stern tube seals) of 2.2 to the SUPERVISOR. (See NOTE 4.4)

3.4 Prior to the removal of the cofferdam, submit one legible copy, in approved transferrable media, of Ship's Force notification of the location of the patch and level of protection (single or double barrier) to the SUPERVISOR. (See NOTE 4.4)



(I)(G) “REMOVAL OF COFFERDAM”

3.5 Accomplish cofferdam removal in accordance with 2.2 Appendix D, steps 21 thru 29.

3.5.1 Verify cofferdams (plug, patch, dry chamber, or stern tube seal) and associated hardware installed in 3.2 have been removed.

4. NOTES:

4.1 2.2 and associated forms are available at:

<http://www.navsea.navy.mil/Portals/103/Documents/SUPSALV/UWSH/chap16.pdf>  
<https://secure.supsalv.org/00C5publications.asp>

4.2 Maximum Calculated Draft (MCD) – The maximum draft, calculated during the period in which ship’s draft is affected due to evolutions which add, remove, or change weight. It represents the “worst case” cumulative effect at any one time on trim, list, or draft for the proposed weight changes throughout the period that hull penetrations are in a non-standard configuration. MCD must be known and utilized by SUPERVISOR and Ship’s Force in scheduling work and testing during waterborne maintenance periods.

4.3 A PCP to support installation of a cofferdam (e.g., plug, patch, dry chamber, stern tube seal) is required; the use of Category II Standard Item 009-09 “Process Control Procedure (PCP); provide and accomplish” of 2.1 must be specified in the Work Item.

4.4 For boats and craft 65 feet or less in length in lieu of Commanding Officer approval in sections 3.2.2 SUPERVISOR will provide the government approval. In sections 3.3 and 3.4 notifications will be to SUPERVISOR vice Ship’s Force.

ATTACHMENT A

AUTHORIZATION FOR SINGLE VALVE ISOLATION      Date \_\_\_\_\_

Subj: PROVIDE NOTIFICATION OF SINGLE VALVE ISOLATION REQUIREMENT AND PROVIDE PRECAUTIONARY PROCEDURES TO BE EMPLOYED DURING REPAIRS/ALTERATIONS TO SEA-CONNECTED SYSTEMS.

Ref: (a) OPNAVINST 3120.32 Series

1. The procedures involved in this repair/alteration will subject the affected area to a flooding hazard during the time the repair is being accomplished. The purpose of this notification is to outline the responsibilities for precautionary measures placed upon the contractor and the ship while the repairs/alterations are in progress.

2. System: The repairs/alterations to be accomplished to the following system:  
\_\_\_\_\_ Component/Space \_\_\_\_\_

3. Prior to Commencing work, the contractor must provide:

- a. A procedure, in accordance with the requirements of NAVSEA Standard Item 009-77, has been developed and approved by the SUPERVISOR (Copy Attached).
- b. The sequence of repairs to be accomplished, including drawings of the system and valve locations. The proposed system isolation must be discussed and mutually agreed upon between the ship, SUPERVISOR, and the contractor.
- c. Identify possible hazards of single valve isolation failure. \_\_\_\_\_
- d. Expected start \_\_\_\_\_ and completion \_\_\_\_\_ for single valve isolation evolution.
- e. Watertight boundaries have been defined, sighted, tagged out and verified. \_\_\_\_\_

4. During the period of this repair, the following minimum precautions are required:

- a. Ship's Supervisor, E-7 or above, must be present to verify single valve isolation and breaking of pressure boundary.
- b. Ship's Force will provide a watch on the affected system and monitor for leaks, etc.
- c. Ship will maintain appropriate state of damage control readiness.

5. See attached drawing of system and valve locations.

\_\_\_\_\_  
Ship's SRA Coordinator                      Engineering Officer                      Commanding Officer/approval

\_\_\_\_\_  
Ship Repair Officer (SRO)/Project Management Officer (PMO) (Notification made to Waterfront Operations Officer)

(Held on site for SBS Review)

ATTACHMENT B  
COFFERDAM PCP REVIEW GUIDE  
Minimum Requirements and Critical Factors  
References

1. NAVSEA STD ITEM 009-01, General Criteria; accomplish
2. NAVSEA STD ITEM 009-09, Process Control Procedure (PCP); provide and accomplish
3. S0600-AA-PRO-160 Underwater Ship Husbandry Manual, Chapter 16 (Appendix C, D, E, F, G; Table 16-9)
4. NAVSEA STD ITEM 009-77, Cofferdam Requirements
5. NAVSEA STD ITEM 009-24, Authorization, Control, Isolation, Blanking and Tagging Requirements; accomplish
6. MIL-STD-777, Schedule of Piping, Valves, Fittings, and Associated Piping Components for Naval Surface Ships or 802-5959353, MIL-STD-777 Modified for DDG-51 Class
7. NAVSEA STD ITEM 009-04, Quality Management System; provide

All cofferdam PCPs must include the following MINIMUM criteria, including Critical Factors<sup>1</sup>, as appropriate, preferably in the order shown below (for further elaboration, see the applicable Reference):

Criteria	Ref	Justification	YES	NO	N/A
1. ADMINISTRATIVE CONTROLS.					
1.1.SHIP'S NAME	1	3.2.5.1			
1.2.SHIP'S HULL NUMBER	1	3.2.5.1			
NUCLEAR VESSEL?					
1.3.CONTRACTOR'S NAME	2	Attachment A			
1.4.CONTRACTOR'S ADDRESS	2	Attachment A			
1.5.WORK ITEM AND PARAGRAPH	2 1	Attachment A 3.2.5.1			
1.6.PCP TITLE	2	Attachment A			
1.7.PCP NUMBER (WITH REVISION)	2	Attachment A			

1.8.DATE OF PCP DEVELOPMENT	2	Attachment A			
1.9.PCP SUBMISSION DATE	2 1	Attachment A 3.2.5.4			
1.10. TITLE OF CONTRACTOR'S REPRESENTATIVE. The individual responsible for creating the PCP.	1	3.2.5.4			
1.11. APPROVAL SIGNATURE	2	Attachment A			
2. PURPOSE/SCOPE. Describe the process and: (a) Type of cofferdam (b) Affected hull opening (c) Affected equipment/system(s)	2 3	Attachment A Appendix C			
3. PERSONNEL QUALIFICATIONS.	2 3	Attachment A 16-10.2.3			
3.1.Diver Training Plan. Note the Diving Contractor's Training Plan & documentation complies with Reference 3, 16-10.2.1 & 10.2.2.	3 3 3 3 3	16-10.2.1 16-10.2.2 16-10.2.4.1 16-10.2.4.2 16-10.2.4.3			
3.2.Diver Competency. Note the Divers: (a) Are ADCI recognized with 7 years (min.) commercial diving experience; (b) Have current medical physical screening; (c) Have current CPR and First Aid certification; (d) Have cofferdam program qualification; (e) Have performed six (6) cofferdam installations; (f) Have performed a cofferdam installation within the past six (6) months.	3 3 3 3 3	16-1.6 16- 10.2.3.3.1 16- 10.2.3.3.2 16- 10.2.4.2.5 16- 10.2.4.2.8			
3.2.1. Minimum Diver Cofferdam Training Requirements. Require the completion of Reference 3, Appendix E demonstrating Diver fundamental cofferdam knowledge.	3 3 3 3	16-5.2.20 16-10.2.2 16- 10.2.3.3.4. (c) Appendix E			
3.3.Engineering. Specify NON-standard cofferdam(s) <sup>2</sup> were designed by a degreed Engineer or Professional Engineer.	3 3	16-3.11 16-10.2.3.1			

3.4.Fabrication Personnel. Note Contractor Welders are qualified to Company’s approved welding procedure.	3 3	16-10.2.3.2 16-10.2.4.3			
4. SAFETY GUIDELINES.					
CF 4.1.Personnel Protective Gear. Note that the minimum required PPE will be used and provide several examples.	2	Attachment A			
4.2.Hazardous Materials. Note Hazardous Material Identification and minimization methods comply with NAVSEA STD ITEM 009-03, Toxic and Hazardous Substances; control, as required.	2	Attachment A			
4.3.Emergency Flooding Plan. Whenever single-valve protection is in place, include in the written notification to the ship a specific plan for immediate installation of a replacement piping component or internal sealing blank. Provide a note indicating that S/F is responsible for developing an on-site Emergency Flooding Plan (dewatering response), which includes additional emergency dewatering equipment that must be operationally ready before commencing work and available for the entire time single valve protection is in place.	3 3 3 3 3	16-4.7.1.5 16-5.2.10 16-7.6.5 16-10.2.6 16-10.2.6.9			
4.4.Joint Safety Brief. Note participation in a pre-job Joint Safety Brief, if Contractor attendance was required.	2	3.4.3			
CF 4.5.Posted Safety Precautions – Warning Signs. Specify and describe each of the following (e.g., figure, sketch, etc.):					
4.5.1. Warning Sign posted at Quarter Deck to space that contains the system impacted by the PCP.					
4.5.2. Warning Sign posted at entrance to space that contains the system impacted by the PCP.					
4.5.3. Warning Sign posted at seawater supply manifold (eductor), if applicable.					
4.5.4. Warning Sign at deck edge in way of cofferdam support rigging, if applicable.					
5. COFFERDAM AND INTERNAL BLANK DESIGN.					

<p>5.1.Cofferdam Design. Specify a suitable capacity cofferdam, including:</p>	<p>3 3 3 3</p>	<p>16-3.7 16-3.8. (7) 16-10.2.4.5 Appendix C: 1-7</p>			
<p>5.1.1. Supporting Documentation. Require design and maintenance records that comply with Reference 3, Paras. 16-5.2.7 (patches), or 16-6.6.4 (dry chambers), or 16-7.6.3 (stern tube seals), including, as necessary: (a) Fabrication drawing(s) (b) Inspections (c) Engineering Calculations (d) Cofferdam Rated depth (e) Maximum hull opening size (f) Gasket requirements (g) Eductor and vent line requirements (h) Patch specific hull opening (i) Attachment and alignment requirements (j) Maintenance records Note: Commercially procured plugs from an approved manufacturer do not require a design sketch. Cofferdam designs from NAVSEA approved DWGs or Reference 3 do not require engineering calculations.</p>	<p>4 3 3 3 3 3 3 3 3 3</p>	<p>3.2.1 16-3.7 16-5.2.7 16-5.2.8 16-6.6.4 16-6.7.4 16-7.6.3 16-10.2.4.5</p>			
<p>5.1.2. Identification. Require an installed data plate or engraved serial number on cofferdams, corresponding to supporting documentation.</p>	<p>3 3 3</p>	<p>16-5.2.7 16-6.6.4 16-10.2.4.5</p>			
<p>5.1.3. Templating. Note the cofferdam is contoured to fit the hull curvature, as necessary.</p>	<p>3 3 3 3 3 3 3 3 3</p>	<p>16-2.1.2.2 16-2.1.2.3 16-3.10 16-5.3.3 16-6.7.3 16-7.7.3 16-8.1 16-8.2 Appendix C</p>			
<p>5.1.4. Overall Dimensions. Specify the gross dimensions of the cofferdam<sup>3</sup>.</p>	<p>3 3</p>	<p>16-10.2.4.5 16-3.8</p>			
<p>5.1.5. Material Types and Thicknesses. Specify the appropriate material types and thicknesses conforming to Reference 3, Section 9<sup>3</sup>.</p>	<p>3 3</p>	<p>16-3.8 16-10.2.4.5</p>			

<p>5.1.6. Stiffeners. Specify the size and spacing of the stiffeners, as necessary<sup>3</sup>.</p>	<p>3 3 3 3 3 3 3</p>	<p>16-2.1.2.2 16-3.8 16-5.1.1 16-6.2 16-9.1.1.2 16-9.2.3.7 16-9.5.4</p>			
<p>5.1.7. Eductor, Air Supply and Vent. Specify:  (a) As necessary, attachment locations of the eductor, air supply and vent, including suction side closure valves<sup>3</sup>.  Note: All patch pipe nipples used to attach external vent lines must have valves installed to secure the space when dewatering is complete.  (b) As necessary, size and type of eductor, air supply and vent<sup>3</sup>.  Note: External vent lines must be non-collapsible hoses.  (c) As necessary, that the cofferdam must be vented to atmosphere by an internal vent or an external non-collapsible vent line.  Note: When using an internal vent, communications must be established between topside and internal space workers to ensure that the internal vent valve is open prior to eductor operation.  (d) As necessary, that a vent line (internal or external) must be installed and opened before dewatering to prevent a vacuum and overloading the patch.  (e) As necessary, a caution tag on all internal vents stating: "EXTERNAL COFFERDAM VENT VALVE. IF WATER PRESENT OR PRESSURIZED AIR RELEASED WHEN OPENED, TAKE ACTION TO CONFIRM COFFERDAM ADEQUACY."</p>	<p>3 3 3 3 3 3 3</p>	<p>16-3.8 16-3.9 16-5.2.2 16-5.2.14 16-5.3.4 16-6.7.5 Appendix A</p>			
<p>5.1.8. Gasket Design. Require gasket to be fabricated from ASTM D 1056-00 Type 2, Class B or C, Grade 1 or 2 closed cell foam and a minimum of 3 inches in width (complying with Reference 3, 16-9.3.1 or 16-9.3.2, as applicable).</p>	<p>3 3 3 3 3</p>	<p>16-3.8 16-5.2.3 16-9.3.1 16-10.2.4.5 Appendix A</p>			
<p>5.1.9. Gasket Adhesive. Specify that a marine-CF grade adhesive was used to mount the gasket to the cofferdam flange.</p>	<p>3 3</p>	<p>16-5.1.1 Appendix A</p>			
<p>5.1.10. Positive Securing Device Design. Specify the method used to secure the cofferdam to the hull (e.g., J-bolt, hogging lines, etc.)</p>	<p>3 3 3</p>	<p>16-3.8 16-3.12 Appendix F</p>			

5.1.10.1.	J-Bolt Minimum Requirements. Refer to, and include, Reference 3, Appendix F if a j-bolt is used.	3 3	16-9.2.3.4 Appendix F			
5.1.11.	Mechanical Fasteners. Specify the fastener type, as necessary.	3 3	16-3.8 16-9.4			
	5.2.Internal Sealing Blank Design and Documentation. If an internal sealing blank is necessary, require the installation of a less than ½-inch vent valve in the blank and specify:  Note: Vent lines must be less than ½” IPS or else a temporary reducer must be installed to make the opening less than ½” IPS.	3 3 3 3 3 3 3	16-3.4.2.1. (2) 16-4.7.1.1 16-4.7.1.2 16-4.7.1.5 16-5.2.1 16-5.2.2 App D: 2, 19			
5.2.1.	Blank conforms to Standard DWG# 845-4612172(latest applicable revision).	5	3.9			
5.2.2.	Gasket conforms to MIL-PRF-1149 (latest revision).	5 6	3.9 Cat D-1 & D-3			
5.2.3.	Fasteners conform to with MIL-DTL-1222J.	5 6	3.9 4.15			
5.2.4.	Positive attachment of a Danger Tag.	3 5 5	Appendix D: 19 3.2 3.9.1			
5.2.5.	Require the blank to be documented on a certified check-off sheet (Reference 3, Appendix D) verifying its installation and removal.	3 5	App D: 2, 19, 22, 23 3.5			



<p>5.3.Rigging Plan. Specify a rigging plan to positively secure the cofferdam to the hull, including, as necessary:</p> <p>(a) Lifting requirements</p> <p>(b) Suitable rigging equipment (e.g., chainfalls, turnbuckles, shackles, bellybands, hogging lines, chafing gear, counterweights)</p> <p>(c) Securing and attachment requirements (e.g., padeye dimensions and locations) and consideration of rigging load requirements, per Reference 3, Section 9</p> <p>(d) Manufacturer and weight testing requirements (Lifting Straps, Padeyes, Wire)</p> <p>(e) Direction and magnitude of expected loads from installation, use, and removal of the cofferdam</p> <p>(f) Rigging points and supporting structure designed with the factors of safety from Reference 3, Table 16-6.</p> <p>Note: If rigging to existing ship structure include the following statement: "All existing ship structure selected for rigging purposes, in accordance with this procedure, must be visually inspected, before its use, for any questionable indications that would appear to compromise its strength (e.g., cracks, unintentional holes, severe corrosion) or items or structure that appear insufficient to carry the intended load(s). This authorization is ONLY applicable to the installation and removal of the cofferdam of this procedure." If Contractor personnel are unclear or unsure as to whether an item is acceptable to rig from, contact the SUPERVISOR immediately for clarification / approval.</p>	<p>3</p> <p>3</p> <p>3</p> <p>3</p> <p>3</p> <p>3</p> <p>3</p> <p>3</p> <p>3</p> <p>3</p> <p>3</p> <p>3</p> <p>3</p> <p>3</p> <p>3</p> <p>3</p> <p>3</p> <p>3</p> <p>3</p> <p>3</p> <p>3</p> <p>3</p>	<p>16-3.12</p> <p>16-5.2.6</p> <p>16-5.3.4</p> <p>16-5.3.5</p> <p>16-6.7.6</p> <p>16-7.7.5</p> <p>16-9.2.3.4</p> <p>16-9.5.2</p> <p>16-9.5.3</p> <p>16-10.2.5.2</p> <p>Appendix B</p> <p>Appendix F</p>			
<p>5.4.PREPARATION.</p>					
<p>5.4.1. Patch and Plug Inspection. Include Reference 3, Appendix C Patch and Plug Inspection Checksheet and require its completion confirming cofferdam inspection.</p>	<p>3</p> <p>3</p> <p>3</p> <p>3</p> <p>3</p> <p>3</p> <p>3</p> <p>3</p> <p>3</p> <p>3</p> <p>3</p>	<p>16-3.7.3. (b)</p> <p>16-3.8. (7)</p> <p>16-4.7.1.3</p> <p>16-4.7.1.6</p> <p>16-5.2.8</p> <p>16-5.2.11</p> <p>16-6.6.5</p> <p>16-6.7.4</p> <p>16-10.2.4.4</p> <p>Appendix C</p>			
<p>5.4.2. Freeboard. Note that watertight integrity of 4-feet (MIN) above the maximum anticipated draft must be maintained.</p>	<p>4</p>	<p>3.1</p>			

CF	5.4.3. Hull Opening or Access Cut Location. To locate cofferdam, specify, as necessary:				
	5.4.3.1. Hull Opening Item #. Referenced on docking drawing.				
	5.4.3.2. Hull Opening Size. Referenced on docking drawing.				
	5.4.3.3. Hull Fairing. Referenced on docking drawing.				
	5.4.3.4. Hull Opening Strainer Bars. Detailed on the seachest drawing and referenced on the piping drawing.				
	5.4.3.5. Access Cut. In lieu of hull opening, detail the location and access cut size.				
	5.4.3.6. Surface Preparation. Inspect and clean hull surfaces to obtain a 100% seal.	3 3 3 3 3 3 3	16-4.8.6 16-4.9.2 16-5.4.2 16-5.2.6 16-6.8.1 16-7.8.1 Appendix C		
CF	5.4.3.7. Sealing Surface, Hull. A 3-inch minimum sealing surface on the hull around the opening to accommodate the minimum cofferdam gasket width.	3 3	16-9.3.1. (b) App D: 5		
	5.4.4. Briefing. Specify a method ensuring cognizant personnel must have direct knowledge of the requirements before starting the process.	2	Attachment A		

<p>5.4.5. On-site Documentation. Specify that the following on-site documentation must be available for the duration of the process, separately or as part of the PCP.</p> <ul style="list-style-type: none"> <li>(a) Applicable System Drawings.</li> <li>(b) Approved PCP</li> <li>(c) Reference 3</li> <li>(d) Applicable Standard Forms. Including but not limited to, Reference 3, Appendices C, D and G, as necessary</li> <li>(e) Rigging Plan</li> <li>(f) Cofferdam Design Package</li> <li>(g) Emergency Flooding Plan</li> <li>(h) Diving Contractor’s Safe Practices Manual</li> <li>(i) Docking Plan Drawing.</li> </ul>	<p>2 3</p>	<p>Attachment A 16-10.2.6</p>			
<p>5.4.6. PCP Control. Specify a method establishing administrative control of the authorized PCP for the duration of the process, including a record of the data demonstrating satisfactory completion of the procedure. Note: This is normally accomplished by a First-Line Supervisor ensuring all personnel must maintain compliance with PCP requirements.</p>	<p>2 2</p>	<p>3.8 Attachment A</p>			
<p>5.4.7. Notifications.</p>					
<p>5.4.7.1. Government. Notify the Government (G) of the start of the process, in compliance with Reference 7, Para 3.8.2. Label the notification sign-off as: “(V)(G) START OF PROCEDURE”.</p>	<p>2 2</p>	<p>Attachment A 3.13</p>			

<p>5.4.7.2. Ship's Force Notification of Cofferdam Installation (Location) and Single Valve Protection. Include, and complete, as required, Reference 3, Appendix G Report of Ship's Responsibility for Patch Installation and/or Single Valve Protection confirming the Ship's C.O. or Designated Representative have been notified and acknowledge the cofferdam's location (if installed) and level of valve protection. Note: Unlike single/double valve protection, weld repairs to the hull do not require App. G as implied by Ref. 3, 16-10.2.6.6.</p>	<p>4 4 3 3 3 3 3 3 3 3 3 3 3 3 5</p>	<p>3.2.2 3.2.4 16-4.7.1.3 16-4.7.1.4 16-5.2.1 16-5.2.2 16-5.2.9 16-5.2.10 16-6.6.10 16-7.6.5 16-7.6.6 16-10.2.6.6 3.1</p>			
<p>5.4.8. Leak Rate. Specify an appropriate leak rate.</p>	<p>3 3 3 3</p>	<p>16-4.7.1.8 16-5.2.17 16-6.6.8 16-7.6.8</p>			
<p>5.4.9. Inspection Dive. Note a pre-installation inspection dive must be accomplished verifying existing conditions.</p>	<p>3 3</p>	<p>16-3.6 16-7.7.4</p>			
<p>5.4.10. Communications. Specify mandatory two-way communication (e.g., hand-held radio, sound powered telephone) between the Contractor (Surveillance Personnel) and Ship's Force (Quarterdeck or OOD Station) for the duration of the process.</p>	<p>3 3 3 3 3 3 3</p>	<p>16-3.4.2.6 16-4.8.4 16-5.2.14 16-5.5.1 16-10.2.5.1 App D: 14, 21</p>			
<p>CF 5.4.11. Dewatering.</p>					
<p>5.4.11.1. Dewatering. If necessary, require installation, tagging (as required) and inspection of all vent lines, eductors and air supply lines (dry chambers), in accordance with Reference 3, Appendix D, as necessary.</p>	<p>3 3 3 3 3 3 3 3 3 3 3</p>	<p>16-5.2.2 16-5.2.14 16-5.2.15 16-5.2.18.1 16-5.2.18.2 16-5.3.4 16-6.6.7 16-6.7.5 16-7.6.6 Appendix D</p>			

CF	5.4.11.2. Pumping, Seawater Supply. If necessary, require maintenance of a seawater supply (supply valve wired open and either a backup fire pump or secondary fire main).				
CF	5.4.12. Operational Compliance Check-List. Include, and complete, the Operational Check-List, Reference 3, Table 16-9.	4 3	3.2.3 16-10.3.1		
	5.5.INSTALLATION.				
	5.5.1. Installation Checksheet. Include Reference 3, Appendix D Patch and Plug Installation Check sheet and complete only those steps pertaining to cofferdam installation.	3 3 3 3 3 3	16-3.13 16-4.7.1.3 16-4.7.1.9 16-5.2.11 16-5.2.19 Appendix D		
	5.5.2. Verify System and Hull Opening. Verify the removed valve or system corresponds to the system blanked and the hull opening.	3	16-5.4.1		
CF	5.5.3. Locate and Position Cofferdam. Require: (a) Cofferdam to be located in conjunction with the Rigging Plan and Inspection Dive. (b) A 4-foot minimum freeboard (conforming to GOS, S9AA0-AB-GOS-010, Section 045) (c) A 6-inch minimum clearance between the cofferdam side and hot work area, if applicable. If the 6-inch minimum clearance cannot be maintained provide written justification.	4 3 3 3 3 3 3 3	3.1 3.6 3.12 5.3.5 6.7.6 7.7.5 App C: 1b, 1c App D: 1		
CF	5.5.4. Verify Cofferdam Seal (Watertight Integrity). Require Divers to verify cofferdam's watertight integrity, and, if necessary, retightening of the primary means of cofferdam attachment to establish a watertight seal.	3	Appendix D		
	5.5.4.1. Notification of Cofferdam Seal. Require Lead Shop notification that a seal has been established.	3	Appendix D		

CF	<p>5.5.5. Internal Seal Blank. If necessary, require:</p> <p>(a) The installation of an internal seal blank, conforming to the specified design requirements, immediately after removal of the damaged (or repair) component (internal piping or watertight boundary is opened) to maintain double-valve protection.</p> <p>(b) The Contractors to confirm that an internal seal blank with a less than ½” diameter vent valve has been installed immediately after removal of the damaged (or repair) component.</p>	<p>3 3 3 3 3 3 3</p>	<p>16-3.4.2.1. (2) 16-4.7.1.1 16-4.7.1.2 16-4.7.1.5 16-5.2.1 16-5.2.2 App D: 2, 19</p>			
CF	<p>5.5.6. Test &amp; Inspection Plan; Acceptance &amp; Rejection Criteria. Include a Test &amp; Inspection Plan denoting the relevant acceptance and rejection criteria, in compliance with Reference 7, Paras. 3.9.1 and 3.10.1.</p>	<p>2 7 7</p>	<p>Attachment A 3.9.1 3.10.1</p>			
	<p>5.5.7. Monitoring. Require cognizant personnel (e.g., Divers or Ship’s Force) to monitor watertight integrity of all applicable cofferdams (with dewatering equipment secured) while actually providing single or double-valve protection at intervals no greater than every 7 days for patches and continuously for dry chambers (when occupied).</p> <p>Note 1: The vent valve on internal seal blanks facilitates internal vent cofferdam monitoring.</p> <p>Note 2: The blank vent valve may be left shut when not temporarily opened by the ship's sounding and security detail for patch or plug seal monitoring or, upon <u>approval by the Ship</u>, the blank vent valve may be left continuously open to maintain cofferdam differential pressure.</p>	<p>3 3 3 3 3 3 3 3</p>	<p>16-3.4.2.5(4) 16-5.2.2 16-5.2.18 16-6.6.9 16-6.7.2 16-7.7.2 Appendix D: 19 Appendix G</p>			
	<p>5.6.REMOVAL.</p>					
	<p>5.6.1. Removal Checklist. Remove cofferdam and complete those remaining steps in Reference 3, Appendix D Patch and Plug Installation Checksheet applicable to the removal phase of the cofferdam procedure.</p>	<p>3 3 3 3 3 3 3 3 3</p>	<p>16-3.13 16-4.7.1.3 16-4.7.1.9 4.8.1 4.9.7 16-5.2.11 16-5.2.19 5.5 7.9 Appendix D</p>			
CF	<p>5.6.2. Removal/Installation Equipment, On-site. Equipment to move/manipulate the component must be available on-site.</p>					

CF	5.6.3. Cofferdam Seal Verification. Either open the ½-inch vent valve or loosen blank fasteners to slightly spread (open) the seal and verify the cofferdam is holding back sea pressure. If leakage exists correct cofferdam seal.	3 3 3 3	16-4.8.9 16-4.8.10 16-5.5.1 Appendix D			
CF	5.6.4. Internal Sealing Blank. Remove internal sealing blank and retain on-site for immediate installation, if necessary.	3	Appendix D			
CF	5.6.5. Double Valve Protection. Verify reestablishment of double-valve protection after component has been installed and 24-hour surveillance or diver stand-by for single-valve protection is no longer required.	3	Appendix D			
CF	5.6.6. Divers Stand-By, Removal. Require Divers to be on stand-by during removal of internal blank and re/installation of component.	3	Appendix D			
CF	5.6.7. Verify System Integrity. Require loosening of cofferdam after the component is installed to verify the flange seal is tight (zero leaks) and, if not, the Divers must retighten the cofferdam to reestablish watertight integrity of the component. When seal is verified, remove the cofferdam.	3	Appendix D			
<p>Notes.</p> <ol style="list-style-type: none"> <li>Items referenced to this note are considered “critical factors, which have direct bearing on the process quality and safety” in accordance with Reference 2, Para. 3.1.3 and are either only generally implied in the References or are not readily specified but are nevertheless considered critical and required for a successful cofferdam process. These Items are marked “CF” in this Review form.</li> <li>Non-standard cofferdams are cofferdams other than those provided by Reference 4, Section 9.</li> <li>Can be included as part of design sketch.</li> </ol>						

NAVSEA  
STANDARD ITEM

FY-24

ITEM NO: 009-78  
DATE: 25 OCT 2022  
CATEGORY: II

1. SCOPE:

1.1 Title: Passive Countermeasures System (PCMS) Material; repair

2. REFERENCES:

2.1 Standard Items

2.2 RIM, Passive Countermeasures System (PCMS) Repair/Installation Methods

2.3 PHS&T, Passive Countermeasures System Packaging, Handling, Storage and Transportation Plan

2.4 ACD 05P1, Passive Countermeasures System (PCMS) Access, Material Control and Disposal Manual

2.5 RIM, Passive Countermeasures System (PCMS) Repair/Installation Methods for PCMS Material Type 3R SLT3

2.6 PHST, Passive Countermeasures System Packaging, Handling, Storage and Transportation Plan for PCMS Material Type 3R SLT3

2.7 ACD, PCMS SLT3 Access, Control and Disposal Manual (CVN Class Ship PCMS Material)

3. REQUIREMENTS:

3.1 Remove existing and install new PCMS material in accordance with 2.2 through 2.4 on CG, DDG, and LPD class ships; and 2.5 through 2.7 on CVN class ships.

3.1.1 Accomplish additional PCMS material handling and storage requirements in accordance with 2.3.

(V) "ENVIRONMENTAL REQUIREMENTS"

3.1.2 Verify the environmental requirements of Section C.1 of 2.2 are met prior to application of primers, tiles, caulking, and paint.



(V) "WELD FAIRING"

3.1.3 Verify the fairing of weld seams is in accordance with Section C.3 of 2.2.

(V)(G) "FINAL INSPECTION"

3.1.4 Accomplish a final inspection of newly installed PCMS material to verify correct installation.

3.1.5 Accomplish surface preparation and preservation for topcoat of new PCMS material in accordance with Section C.6 of 2.2.

3.2 Accomplishment of cleaning and painting for new and disturbed surfaces must be in accordance with NAVSEA Standard Items (See Note 4.1).

4. NOTES:

4.1 If cleaning and painting for new and disturbed surfaces are required; the use of Category II Standard item 009-32 "Cleaning and Painting Requirements; accomplish' of 2.1 will be specified in the Work Item.

NAVSEA  
STANDARD ITEM

FY-24

ITEM NO: 009-79  
DATE: 25 OCT 2022  
CATEGORY: II

1. SCOPE:

1.1 Title: Government Owned Material (GOM) Status for Multi-Ship Multi-Option availabilities; report

2. REFERENCES:

2.1 None.

3. REQUIREMENTS:

3.1 Provide an accurate accounting of Government Owned Material (GOM), traceable to the Lowest Replaceable Unit (LRU), in the custody of the contractor. For this tasking, GOM is defined as government furnished material (GFM) and contractor acquired material (CAM) which the Navy has either paid for or provided directly to the contractor.

3.2 Prepare and submit one legible copy of GOM Status Reports in approved transferrable media (similar or equal to Excel).

3.2.1 This report must specify all the current inventory of GOM baseline, residual, and excess assets including COSAL material, installation and checkout (INCO) spares, GFM, and CAM. Specific content requirements must be as specified in 3.2.2 and must include the following:

3.2.1.1 Allowance Parts List/Allowance Equipage List (APL/AEL). An alphanumeric code, minimum of 8 characters and maximum of 11 characters, that identifies the unique characteristics of an equipment or system provisioned by the Naval Inventory Control Point, or the non-installed material collectively known as equipage.

3.2.1.2 Document GFM Requisition/CFM purchase order number.

3.2.1.3 National Item Identification Number. Represents the last 9 digits of the 13-digit Naval Stock Number and identifies a specific item catalogued in the Federal Supply System.

3.2.1.4 Part Number. A manufacturer's part numbers, drawing numbers, and model, type, or source controlling numbers used to identify an item of production or supply.

3.2.1.5 Commercial and Government Entity (CAGE). A 5-digit number assigned to an individual supplier, manufacturer, corporation, or government activity for identification purposes.

3.2.1.6 Unit of Issue. A 2-character abbreviation code used to identify the types of units under which material is issued. For example, shoes would be issued as a pair (PR), while hammers would be issued one at a time or each (EA).

3.2.1.7 Allowance/Required Quantity. The total number of a given item of replacement allowed onboard.

3.2.1.8 Quantity on Order. The number of a given item for which requisitions are in process.

3.2.1.9 Quantity Received. The number of a given item acquired as a result of a requisition.

3.2.1.10 Quantity on Hand. The number of a given replaceable item currently in the storeroom/storage location.

3.2.1.11 Unit Price. The cost of the unit of issue (i.e., gross, pair, each, quart, gallon, ton, ounce, etc.).

3.2.1.12 Extended Price. The cost calculated by multiplying the unit price by the quantity of items.

3.2.1.13 Material Accessibility Code (MAC). A 2-character alphabetic code that defines the material's intended use and disposition. Generally speaking, excess assets are available as free issue redistributions while baseline and residual assets are either non-available for redistribution or are negotiable at the SUPERVISOR's discretion. A single item may have multiple MACs assigned to it; some of its quantity on hand could be in each category. Valid MACs include IC (Inaccessible and contractually required), ID (Inaccessible and Deferred), and AR (Accessible and Residual).

3.2.1.14 Unit Identification Code. A 5-digit accounting number that identifies a ship, shore activity, operational unit, agency, contractor or other organized entity that may be involved in acquiring and/or managing material.

3.2.1.15 Type Number Code. A one-digit alphabetic code that identifies the data in position 12-28 as either a document number [R] or a contract number (P).

3.2.1.16 Condition Code. A one-digit alphabetic code that identifies the condition of the material, whether it is ready for issue or in need of some level of repair.

3.2.1.17 Cognizance Code. A 2-position code. The first position identifies the stores account to which the item belongs and the second position identifies the combined technical and inventory manager having jurisdiction over the item.

3.2.1.18 Federal Supply Classification. A 4-position code assigned to designate various groups of common use, commercial type items.

3.2.1.19 COAR/Material Group. A 6-position code locally assigned by the SUPERVISOR to indicate the modernization program under which the work on the ship is being performed or the outfitting material group material is being purchased to support.

3.2.1.20 Item Name. A 48-position nomenclature assigned to an item to describe the item for allowance purposes.

3.2.1.21 Technical Characteristics. A 200-character field used to describe the technical characteristics of an item.

3.2.2 The GOM Report Format (character positions, data element numbers, and field lengths) must use the following table as an illustration of the data elements with their respective character positions and field lengths:

POSITION	DEN REMARKS	DATA DESCRIPTION		PICTURE
1-11	D008G	APL/AEL	X (11)	
12-28	K002/P699	Document/Contract Number	X (17)	
29-37	D046D	NIIN	X (9)	N/R if no NSN assigned
38-67	D001W	Part Number	X (30)	N/R if NSN assigned
68-72	C035	CAGE	X (5)	N/R if NSN assigned
73-74	C005	Unit of Issue	X (2)	
75-79	E372	Allowance Quantity	9 (5)	
80-84	F977C	Quantity on Order	9 (5)	
85-89	F977D	Quantity Received	9 (5)	
90-94	A012	Quantity on Hand	9 (5)	
95-105	B053	Unit Price	9 (11)	
106-116	G101A	Extended Price	9 (11)	
117-118		Material Access Code (AF)	X (2)	
119-120		Material Access Code (AR)	X (2)	
121-122		Material Access Code (IC)	X (2)	
123-124		Material Access Code (ID)	X (2)	
125-129	A002	Unit Identification Code	X (5)	
130	T088	Type Number Code	X	
131	SD041	Condition Code	X	
132-133	C003	Cog	X (2)	
134-137	C042	FSC	X (4)	

POSITION	DEN REMARKS	DATA DESCRIPTION		PICTURE
138-143		COAR	X (6)	
144-191	C004C	Item Name	X (48)	
192-392	T059B	Technical Characteristics	X (200)	N/R if NSN assigned

N/R = Not Required

3.3 Submit the GOM Status Report to the SUPERVISOR 4 days prior to the 50 percent conference and 5 days after the end of the availability.

4. NOTES:

4.1 None.

NAVSEA  
STANDARD ITEM

FY-24

ITEM NO: 009-80  
DATE: 25 OCT 2022  
CATEGORY: I

1. SCOPE:

1.1 Title: Ship Facilities; maintain

2. REFERENCES:

2.1 None.

3. REQUIREMENTS:

3.1 Accomplish the following requirements to keep the ship habitable and maintain the ship's facilities operational at times when spaces are inhabited by the crew.

3.1.1 Maintain operational sanitary services.

3.1.2 Identify span of time each CHT zone will be taken out of service.

3.1.3 Install and maintain temporary, primary, and back-up CHT pumps during such time that ship's CHT system is inoperative.

3.1.4 Ensure that the ship's power, steam, fire main, seawater service system, flushing system, heating system, CHT system, potable water, air conditioning, and ventilation is maintained operational.

3.1.5 Install temporary cables, jumpers, pumps, spool pieces, valves, hoses, and ducts when required to maintain systems operational.

3.2 Coordinate disruption of the facilities listed in 3.1 and systems listed in 3.1.4 with the ship via the SUPERVISOR.

3.3 Submit one legible copy, in approved transferrable media, of a detailed schedule showing when each facility/system will be disrupted to accomplish 3.1.5 and include the following:

3.3.1 Original schedule is due 5 days prior to availability start date.

3.3.2 Submit updated schedules weekly throughout the entire availability.

3.3.3 Include each compartment disrupted and specify the system(s) affected, with the scope of the disruption.

3.4 Remove the temporary installations and restore the systems to operational conditions when directed by the SUPERVISOR.

4. NOTES:

4.1 The contractor is only required to maintain those systems operational which he disturbs or disrupts in the performance of work in the Job Order, and only to the extent possible, using temporary methods consistent with 3.1.5.

NAVSEA  
STANDARD ITEM

FY-24

ITEM NO: 009-81  
DATE: 25 OCT 2022  
CATEGORY: I

1. SCOPE:

1.1 Title: Compartment Closeout; accomplish

2. REFERENCES:

2.1 Standard Items

3. REQUIREMENTS:

3.1 Submit one legible copy, in approved transferrable media, of a compartment closeout schedule to the SUPERVISOR no later than the 50 Percent Review Conference for all CNO availabilities and non-CNO availabilities 9 weeks in length or longer.

3.1.1 The compartment closeout schedule will be based on the list of affected spaces provided by the SUPERVISOR during the bidding process which lists all affected spaces requiring a compartment closeout along with the assigned Key Event or Milestone. The compartment closeout schedule must contain the following minimum information:

3.1.1.1 Identification of work not completed in each compartment by the Work Item number and associated Key Event or Milestone.

3.1.1.2 Any impact that known work by Ship's Force, Alteration Installation Teams (AIT), Fleet Maintenance Activity (FMA), or other third Party Maintenance Providers will have on the contractor's ability to complete work in the compartment.

3.1.1.3 The date when the contractor expects to complete his work within each compartment. Highlight major trouble spots.

3.1.1.4 An index of the compartment closeout schedule by compartment number listing the page number of where the information about the compartment can be located.

3.1.2 Compartment closeout inspections must be completed at least one day prior to the associated Key Event or Milestone, unless otherwise approved by the SUPERVISOR.

(V)(G) "COMPARTMENT INSPECTION"



3.2 Accomplish a joint inspection with the SUPERVISOR and the Commanding Officer's designated representative upon completion, inspection, and acceptance, by the contractor, of work within each compartment.

3.2.1 Acceptance criteria is completion of all contractor work within the compartment inclusive of associated Work Items, and settled changes to associated Work Items. Stage 3 through Stage 7 testing need not be complete prior to compartment inspection.

3.2.1.1 Provide a listing of all contractor work applicable to the compartment for use in evaluating the status of contractor's work completion during the inspection.

3.2.2 Identify and list any incomplete work or discrepancies for each compartment on the compartment closeout schedule. Deficiencies must be updated and reviewed at the weekly progress meeting until completed.

3.2.2.1 Inspection of each compartment must be considered complete when all contractor responsible deficiencies are remedied or adjudicated. The SUPERVISOR, Commanding Officer's designated representative and the contractor will sign the Compartment Closeout Schedule indicating contractor work in the compartment is complete.

3.2.3 Turn over each compartment accepted in accordance with 3.2.1 to Ship's Force for maintenance/use and indicate on the updated compartment closeout schedule as complete.

3.3 Update the compartment closeout schedule at the weekly progress meeting after the first report is published.

3.3.1 Include any new work or changes in work boundaries via the Contractor Furnished Report (CFR)/Request for Contract Change (RCC) process.

3.3.2 Highlight changes from the previous compartment closeout schedule.

3.3.3 Highlight each discrepancy that cannot be corrected prior to their associated Key Event or Milestone date, providing the reason and expected completion date.

#### 4. NOTES:

4.1 The ship's Commanding Officer will furnish the SUPERVISOR the work by compartment, including the schedule, which is planned for accomplishment by Ship's Force on a weekly basis.

4.2 For purposes of this item, the term compartment includes compartments, tanks, and voids. The terms "space/spaces", "room/rooms", and "compartment/compartments" are synonymous.

4.3 Tanks inspected and closed with a work item are exempt from the requirements of 009-81 of 2.1.

4.4 Interface conflicts in the closeout schedule will be resolved as they occur.

4.5 The contractor is not required to conduct a compartment closeout for spaces in which only services were routed. If damage is caused by the routing of services, the contractor is only required to repair the damaged areas.

4.6 Testing Stages defined in 009-67 Integrated Total Ship Testing; manage, of 2.1.

NAVSEA  
STANDARD ITEM

FY-24

ITEM NO: 009-82  
DATE: 25 OCT 2022  
CATEGORY: I

1. SCOPE:

1.1 Title: Installation of Equal Component Vice Specified Component; report

2. REFERENCES:

2.1 None.

3. REQUIREMENTS:

3.1 Submit one legible copy, in hard copy or approved transferrable media, of a report listing the following data to the SUPERVISOR in each instance when the Work Item allows, and the contractor chooses, to install "an equal component" vice a "specified component" listed in the Work Item. Provide data to compare the equal component to that specified including the following:

- 3.1.1 Physical dimensions of each
- 3.1.2 Bolting pattern required to install the component
- 3.1.3 Power requirements
- 3.1.4 Size, location, and type of miscellaneous service connections
- 3.1.5 Modifications required for installation
- 3.1.6 Comparison of the characteristics, i.e., gallons per minute, cubic feet per minute, and temperature ranges
- 3.1.7 Submission of the reports must be no later than the 50 percent Conference.

4. NOTES:

4.1 None.

NAVSEA  
STANDARD ITEM

FY-24

ITEM NO: 009-83  
DATE: 25 OCT 2022  
CATEGORY: II

1. SCOPE:

1.1 Title: Wire Rope Assembly; Fabricate

2. REFERENCES:

2.1 S9086-UU-STM-010/CH-613, Wire and Fiber Rope and Rigging

3. REQUIREMENTS:

3.1 Comply with the following specifications when procuring wire rope fittings.

3.1.1 SOCKETS - RR-S-550

3.1.2 FIEGE-TYPE - MIL-S-21433

3.1.3 SWAGE SLEEVES - Commercial, supplied by the same manufacturer as the swaging machine

3.1.4 THIMBLES - FF-T-276 Type 3 only

3.1.5 SHACKLES - RR-C-271

3.1.6 BLOCKS - A-A-59985

3.2 Comply with the following specification when procuring wire rope.

3.2.1 WIRE ROPE AND STRAND – RR-W-410

3.3 Fabricate wire rope assemblies from the materials specified in 3.1 in accordance with the assembly and testing requirements of 2.1.

3.4 Submit one legible copy, in hard copy or approved transferrable media, of a report listing the certification and testing of each wire rope to the SUPERVISOR. The report must list the following information:

3.4.1 Wire Rope testing results in accordance with 2.1.

3.4.2 Certification documentation of qualified assembly personnel in accordance with 2.1 if required.

3.5 Verify each fitting is legibly marked with manufacturer's name or trademark and size.

3.5.1 Shackles and blocks must also be marked with safe working load.

3.5.2 Thimbles are not required to be marked.

4. NOTES:

4.1 None.

NAVSEA  
STANDARD ITEM

FY-24

ITEM NO: 009-84  
DATE: 25 OCT 2022  
CATEGORY: I

1. SCOPE:

1.1 Title: Threaded Fastener Requirements; accomplish

2. REFERENCES:

2.1 Standard Items

2.2 S9086-CJ-STM-010/CH-075, Fasteners

2.3 MIL-STD-777, Schedule of Piping, Valves, Fittings, and Associated Piping Components for Naval Surface Ships

2.4 802-5959353, MIL-STD-777D Modified for DDG-51 Class Schedule of Piping, Valves, Fittings, and Associated Piping Components for Naval Surface Ships

3. REQUIREMENTS:

3.1 General

3.1.1 Replace the following non-Level I fasteners 1/2-inch nominal diameter and smaller with new fasteners of the same material, strength and design;

3.1.1.1 Monel, QQ-N-281, FF-S-85, ASTM 468 Alloy 400

3.1.1.2 CRES, 300 Series, FF-S-85

3.1.1.3 Steel, ASTM A193/A193M B16

3.1.1.4 Steel, Grade 5 and Grade 8

3.1.2 Inspect each fastener intended for reuse for wear and defects. For the exposed portion of each body-bound stud use 075-8.2 of 2.2 for accept or reject criteria. For each other fastener, use Attachment A and paragraph 075-8.3 of 2.2 for accept or reject criteria.

3.1.3 Fasteners larger than 1/2-inch nominal diameter must be retained for reuse to the maximum extent possible. Reuse existing fasteners if the acceptance criteria of Attachment A and paragraph 075-8.2 and 075-8.3 of 2.2 are met.

3.1.3.1 Maintain fastener accountability to ensure fasteners meeting the criteria of

this item are reused in the same joint from which they came.

3.1.3.2 Clean each fastener free of foreign matter (including paint).

3.1.3.3 Chase and tap exposed threaded areas.

3.1.4 Install new threaded fasteners, washers, and lock washers in place of those identified to be missing or defective.

3.1.4.1 Utilize table one, 2.2 through 2.4, to select each replacement fastener when necessary.

3.1.5 Use of black-oxide coated brass threaded fasteners (BOCBTF) is prohibited in the accomplishment of any work. BOCBTFs are most commonly marked with “462”, “464”, “F467C”, “F467D”, “F468C”, and “F468D.”

3.1.6 Fasteners, body-fitted bolts, and studs requiring a permeability factor of 2.0 or less must conform to 500 Series Monel, 316L CRES, or 304 CRES where required.

3.2 Externally threaded fastener installation acceptance criteria unless otherwise specified or approved:

3.2.1 The minimum thread protrusion for each male threaded fastener must be one full thread beyond the face of the nut. The maximum thread protrusion for each male threaded fastener is 10 full threads beyond the face of the nut.

3.2.2 For self-locking (plastic insert) nut installations, the minimum thread protrusion for bolt or stud end may be flush with the face of the nut after the threaded fastener(s) have been installed and tightened. The maximum thread protrusion for self-locking nuts must be 5 threads after the threaded fastener(s) have been installed and tightened.

3.3 Internally threaded fastener installation acceptance criteria must be in accordance with paragraph 075-7.6 of 2.2.

#### 3.4 Use of Temporary Fasteners

3.4.1 Maintain a single log/file of installed/removed temporary fasteners with the following information:

3.4.1.1 System

3.4.1.2 Component (valves, flanges, foundations, brackets)

3.4.1.3 Location (deck, frame, port, starboard, tank, manhole)

3.4.1.4 Company name/badge number/name of mechanic

3.4.1.5 Date installed/date removed

3.4.2 Paint temporary fasteners white unless an alternate color has been authorized by the SUPERVISOR. Minimum requirements for painting fasteners are as follows:

3.4.2.1 Nut Bearing faces (top)

3.4.2.2 Bolt Top of bolt head

3.4.2.3 Stud Both ends of stud

3.4.2.4 Washer Faces (edge and bottom of washer)

3.4.3 Remove temporary fasteners prior to any testing, lagging, and/or painting of systems or components.

3.4.4 Logging-in of temporary fasteners must be accomplished no later than the end of the work shift.

3.4.5 Existing system fasteners used for blanking that will be reused for installation are excluded from the requirement of 3.4.2.

#### 4. NOTES:

4.1 For purposes of this item, temporary fasteners are defined as those fasteners that are installed in lieu of the final fasteners that are specified for system installation. Examples would include temporary fasteners used to hold fittings, valves, or machinery in place.

4.2 One complete thread or one thread length is defined as one complete rotation (360 degrees on a single thread), starting at a point along the thread.



## Attachment A

The following criterion applies to the inspection of fasteners:

1 General inspection: Fasteners must bear markings identifying material to be compatible with the system. Black-oxide coated fasteners and fasteners without markings are not acceptable. Joints with mixed material fasteners are not acceptable.

2. Engaged Thread Area: Cracks are not acceptable.

2.1 Broken, chipped, or missing threads or other indications of brittle material failure, are not acceptable.

2.2 Galling, spalling, or pitting is not acceptable.

2.3 Major defects are not acceptable. A major defect is a single defect (after removal of sharp edges and raised metal) that has a depth over one-half the thread depth.

2.4 Isolated minor defects are acceptable. A minor defect is a single nick, gouge, or flattened thread (after removal of sharp edges and raised metal) that has a depth greater than 1/64-inch, but less than one-half the thread height (depth), and a width less than the thread spacing (pitch). Defects less than 1/64-inch deep may be ignored.

2.4.1 An isolated minor defect that exceeds the width criterion for a minor defect is acceptable when the total length of the defect does not exceed 15 percent of one thread length in any one complete thread.

2.4.2 Any combination of minor defects is acceptable when the total combined length of the defects does not exceed 15 percent of one thread length in any one complete thread.

2.5 Repaired threads that engage with a non-self-locking Class 3-B fit nut, turned with fingers, are acceptable.

3. Non-Engaged Thread Area:

3.1 Cracks are not acceptable.

3.2 For externally threaded fasteners, no minimum thread form is required, except as needed to provide initial thread engagement and passing of the nut.

4. Self-locking nuts must have prevailing torque in accordance with 2.2. Cuts, tears, or looseness in self-locking elements or the adjacent metal is not acceptable.

4.1 Determine adequate torque values in accordance with Table 075-5-1 of 2.2.

5. Deformed or damaged flats on fasteners are not acceptable.
6. Discard fasteners not meeting the acceptance requirements of this item.

ATTACHMENT B

VALVE BODY MATERIAL

	<u>1/</u> Alloy Steel	Carbon Steel	Nonferrous <u>2/</u>
<u>3/</u> Studs and Bolts to MIL- DTL-1222	Grade B-16	Grade B-16	Phosphor Bronze - Any Grade Silicon Bronze - Any Grade Nickel Copper - Class A <u>4/</u>
Nuts to MIL-DTL-1222	Grade 4 or 7	Grade 4 or 7	Phosphor Bronze - Any Grade Silicon Bronze - Any Grade Nickel Copper - Class A or Class B <u>5/</u>
Socket Head Cap Screws	FF-S-86	FF-S-86	

NOTES

1/ Alloy steel is of Composition A - 2-1/4 percent Chromium, one percent Molybdenum, Composition B - 1-1/4 percent Chromium, 1/2 percent Molybdenum, and Composition C - Carbon Molybdenum.

2/ Nonferrous Alloy except Aluminum.

3/ Studs must be Class 2 or 3 fit on the nut end and Class 5 fit on the stud and, except that a Class 3 fit with a thread locking compound may be used where temperatures do not exceed 250 degrees Fahrenheit. The thread locking compound must conform to ASTM D 5363. Check Class 3 fit stud ends in accordance with SAE-J2270.

4/ Fasteners of Nickel Copper Aluminum must be the only type used on sea chest and hull valves.

5/ Nuts of Nickel Copper Alloy, conforming to QQ-N-281 Class A or B, or Nickel Copper Aluminum conforming to QQ-N-286 must be the only type used on sea chest and hull valves.

ATTACHMENT C (DDG-51 Class)

VALVE BODY MATERIAL

	1/ Alloy Steel/Carbon Steel	2/ Nonferrous
3/ Studs and Bolts to MIL-DTL-1222	5/ For services up to and including 650 degrees Fahrenheit; Grade 5 steel	4/ 5/ Phosphor Bronze - Any Grade
	For services to 775 degrees Fahrenheit; Grade B-7 or B-16	Silicon Bronze - Any Grade  Nickel Copper - Class A
	For services to 1,000 degrees Fahrenheit; Grade B-16	
	For services in which JP-5 lubricating oil, or inflammable gas or liquid of any kind, regardless of pressure and temperature, which are within 3 feet of hot surfaces (above 650 degrees F) and where steel tubing is required; Grade 2, 5 or 8 steel	
	Bolting subject to seawater corrosion (other than hull integrity bolting; for hull integrity bolting see Note 4) Connections in contact with bilge regions. Where strength requires ferrous bolting and is exposed to the weather; Class A Nickel - Copper alloy to QQ-N-281 or silicon bronze to ASTM B 98 with dimensions of MIL-DTL-1222. Where greater strength is required, use Nickel - Copper - Aluminum alloy QQ-N-286.	
Nuts to MIL-DTL-1222	5/ For services up to and including 650 degrees Fahrenheit; Grade 5 steel	Phosphor Bronze - Any Grade
	For service to 775 degrees Fahrenheit; Grade 2H or 4 steel	Silicon Bronze - Any Grade
	For services to 1,000 degrees Fahrenheit; Grade 4 steel	
	For services in which JP-5, lubricating oil, or inflammable gas or liquid of any kind, regardless of pressure and temperature which are within 3 feet of hot surfaces (above 650 degrees F) and where steel tubing is required; Grade 5 or 8 steel	Nickel Copper - Class A or Class B  4/ 5/

Nuts to MIL-DTL-1222 (Con't)	Nuts subject to seawater corrosion. Connections in the bilge regions. Where strength requires ferrous material and is exposed to the weather; Class A or B Nickel Copper Alloy to QQ-N-281 or Silicon Bronze to ASTM B 98 with dimensions to MIL-DTL-1222.	
------------------------------	--	--

NOTES

1/ Alloy steel is of Composition A - 2-1/4 percent Chromium, one percent Molybdenum, Composition B - 1-1/4 percent Chromium, 1/2 percent Molybdenum, and Composition C - Carbon Molybdenum.

2/ Nonferrous Alloy except Aluminum.

3/ Studs must be Class 2 or 3 fit on the nut end and Class 5 fit on the stud end, except that a Class 3 fit with a thread locking compound may be used where temperatures do not exceed 200 degrees Fahrenheit. The thread locking compound must conform to ASTM D 5363. Check Class 3 fit stud ends in accordance with SAE-J2270.

4/ Fasteners of Nickel Copper Aluminum must be the only type used on sea chest and hull valves.

5/ Where these materials would constitute part of a galvanic couple, proposals for alternate materials must be submitted for approval.

TABLE ONE  
REPLACEMENT FASTENERS MATERIAL

Application	Fastener	Nut	Other	Comments
Temporary Access (009-05 of 2.1)	MIL-DTL-1222, Grade 304			
Meter, Gauge, Switch, and Thermometer Repair (009-13 of 2.1)	ASTM A 449, Type I, Zinc Coated for Bolts	ASTM A 563 Zinc Coated		May be selected and identified in accordance with SAEJ 2280
Rotating Electrical Equipment (009-17, 009-33 of 2.1)	MIL-DTL-1222 Type I or II, Grade 5, Zinc Coated	Lock Nuts must conform to requirements of the Equipment Technical Manual	Lock Washers must conform to requirements of the Equipment Technical Manual	Self-Locking Hex Nuts must conform to NASM 25027, excluding body fitted bolts and studs.
Electrical Controllers (009-36 of 2.1)	MIL-DTL-1222 Type I or II, Grade 5, Zinc Coated	Lock Nuts must conform to requirements of the Equipment Technical Manual	Lock Washers must conform to requirements of the Equipment Technical Manual	Self-Locking Hex Nuts must conform to NASM 25027, excluding body fitted bolts and studs.
Woodwork (009-37 of 2.1)  Fasteners subject to contact with sea water and bilge water must be coated with a light viscosity epoxy resin prior to installation.	Nickel copper alloy conforming to QQ-N-281, Grades 400 or 405. Nickel copper aluminum alloy conforming to QQ-N-286 (UNS N05500) where greater strength is required. Copper silicon alloy conforming to ASTM B 98, Grades 651 or 655.	Nuts must conform to MIL-DTL-1222.	Flat washers must conform to FF-W-92, Grade I. Lock washers must conform to FF-W-100.	Bolts, studs, and cap screws must conform to MIL-DTL-1222. Wood screws must conform to FF-S-111. Lag bolts (screws) must conform to ASME B18.2.1. Round head bolts must conform to ASME B18.5, Type I, Class One.

<p>Woodwork (009-37 of 2.1)</p> <p>Aluminum and aluminum alloy components and structural members.</p> <p>To avoid bi-metallic corrosion, fastener material composition must be the same material composition as that of the metal components and structural members that they are fastening except as noted in this table.</p>	<p>Corrosion resistant steel (CRES) conforming to SAE-AMS-STD-66, Grades 304 or 316.</p>		<p>Install non-metallic (epoxy plastic, phenolic, polyimide [nylon], Teflon) sleeves over CRES fasteners where they come in contact with the aluminum and aluminum alloy components and structural members.</p>	<p>Fasteners with compositions of copper alloys must not be used in contact with aluminum and aluminum alloy components and structural members.</p>
<p>Shipboard Electrical / Electronic Cable (009-73 of 2.1)</p>	<p>MIL-DTL-1222, Type I</p>			<p>Grade 316, stainless steel, for areas exposed to weather and high moisture areas</p> <p>Grade 2 or 5, carbon steel, zinc plated, for other areas to support work required by individual Work Items</p>

Rotating SIS Electrical Equipment (009-113 of 2.1)	MIL-DTL-1222, Type I or II, Grade 5, zinc coated	NASM-25027, self-locking hexagon nuts, excluding body-fitted bolts and studs.	Lock Washers must conform to requirements of the Equipment Technical Manual	
Valves (009-45, 009-47 through 009-55, and 009-96 of 2.1) – See Attachment B or C (for DDG-51 class).				



NAVSEA  
STANDARD ITEM

FY-24

ITEM NO: 009-85  
DATE: 25 OCT 2022  
CATEGORY: II

1. SCOPE:

1.1 Title: Government Sponsored Planning Yard/Configuration Data Manager (CDM) On-Site Representative Facility; provide

2. REFERENCES:

2.1 None.

3. REQUIREMENTS:

3.1 Provide a separate, lockable, and secure office space for use by the Government Sponsored Planning Yard/CDM On-Site Representative furnished with 2 desks with chairs, lights, heat, air conditioning, electrical outlets, sanitary facilities, filing cabinets, telephone service, janitorial service, and 2, 15-pound fire extinguishers and 24-hour service for the entire contract period.

3.1.1 The facility must have a minimum of 240 square feet of floor space.

3.1.2 The facility must be located within one-quarter mile of the ship.

3.1.2.1 Provide a parking area adjacent to the facility. The area must be lighted and accommodate 2 automobiles simultaneously.

3.1.3 Lighting must provide 28 foot candles of illumination measured at the desktop level.

3.1.4 Heating and air conditioning must be capable of maintaining the temperature between 65 and 78 degrees Fahrenheit.

3.1.5 Provide 2 double-pedestal desks 30-inches wide by 60-inches long.

3.1.5.1 Provide one telephone desk set and one 115-volt, shock resistant, double electrical receptacle for each desk. Each receptacle must be a convenient height and located adjacent to each desk.

3.1.5.2 Provide one swivel chair and one straight-back chair for each desk.

3.1.6 Provide telephone communications with separate circuits for each desk set, between the facility, shipyard, ship, and the municipal telephone system. One telephone line must be capable of digital transmission.

3.1.6.1 Telephone systems designated long distance must be installed in such a manner that the only way long distance calls can be made will be with a long distance calling card (credit card) that must be obtained by the On-Site Representative prior to availability start date.

3.1.7 Provide 4-drawer filing cabinets with lock and keys.

3.1.8 Provide sanitary facilities equipped with drains, hot and cold potable water, and the following:

3.1.8.1 Hot water must be maintained at 120 to 140 degrees Fahrenheit.

3.1.8.2 One lavatory

3.1.8.3 One water closet

3.1.8.4 One soap dispenser

3.1.8.5 One towel dispenser

3.1.9 Facilities must be provided 2 days prior to contract start date through 2 days after the contract completion date unless otherwise specified.

3.2 Provide janitorial services to include sweeping, mopping, buffing, and trash pickup on a daily basis.

3.3 The facility must be in accordance with local building codes, sanitary and current fire regulations. The facility must include smoke alarms, 2, 15-pound fire extinguishers, and sprinkler systems.

3.4 Furnishings and equipment in this item must be maintained in a fully operable condition by the contractor.

3.5 The facility must be delivered to the Government clean, sanitary, damage free, and vermin free.

#### 4. NOTES:

4.1 The On-Site Representative will retain the keys during the entire contract period.

4.2 The SUPERVISOR will identify the Government Sponsored Planning Yard/CDM On-Site Representatives upon request of the contractor.

4.3 The Government Sponsored Planning Yard/CDM On-Site Representatives must obtain the telephone credit card specified in 3.1.6.1 from their command.

NAVSEA  
STANDARD ITEM

FY-24

ITEM NO: 009-86  
DATE: 25 OCT 2022  
CATEGORY: II

1. SCOPE:

1.1 Title: Recovery and Turn-In of Ozone Depleting Substance (ODS); accomplish

2. REFERENCES:

2.1 49 CFR Part 173, General Requirements for Shipments and Packagings

2.2 Department of Defense ODS Reserve Customer Turn-In Procedures, Defense Logistics Agency, dated February 2021

3. REQUIREMENTS:

3.1 Recover Chlorofluorocarbons (CFC) and HCFC-22 refrigerants and halon materials listed in Attachment A that are not recycled back into the specific system's equipment from which they were removed as follows:

3.1.1 Fire suppression (halon) cylinders and canisters with electrical charges or initiators must be deactivated and safety caps must be used to cover exposed actuating mechanisms and discharge ports prior to shipping the intact cylinder.

3.1.2 Recover other halon and CFC materials for turn-in to the DoD ODS Reserve at the Defense Depot Richmond VA (DDRV). All turn ins must be returned to DDRV unless the activity is in Japan, Hawaii or San Diego, California. Empty cylinders must be used to recover the materials. Empty recovery cylinders can be requisitioned through normal MILSTRIP stock ordering procedures from DDRV. The DDRV cylinders used for recovering refrigerants are painted orange, and Halons red. Both have yellow tops and dual port (two valves) to distinguish them from single port valve standard spec gas (virgin) cylinders.

3.1.2.1 Do not mix new materials with used materials and do not mix different types of materials in the same cylinders.

3.1.3 Ensure the recovered materials cylinder is tagged. The tag should be placed beneath the cylinder protective cap or attached securely to the container. Do not stencil on cylinder. The tag must contain the following information:

3.1.3.1 The shipper's DOD Activity Address Code (DODAAC). If the turned-in material originates from a ship or submarine, use the DODAAC of the ship/submarine on the tag.

3.1.3.2 The shipping activity with point of contact and telephone number.

3.1.3.3 The National Stock Number (NSN) that applies to the filled cylinder being returned.

3.1.3.4 The identity of the recovered material (Navy recovered R-XXX, CFC-XXX, or HALON-XXXX).

3.1.3.5 The amount, in pounds, of recovered materials in the cylinder. Do not fill more than 80 percent of its water weight capacity.

3.1.3.6 Apply a warning/hazardous label to the cylinder in compliance with 2.1.

3.1.3.7 The quantity of containers on the pallet or within the shipping crate. When multiple containers with the same NSN are shipped palletized or in a box/crate, apply only one tag/label to the shipment, not to each item.

3.2 Prior to shipping the reclaimed materials to DDRV, notify the SUPERVISOR so that a DD Form 1348-1 MILSTRIP can be prepared and transaction authorization procured.

3.3 Upon receipt of the completed DD Form 1348-1, and transaction authority from the SUPERVISOR, ship the reclaimed materials to:

SW0400,  
DLA DISTRIBUTION RICHMOND, ODSR  
Cylinder Operations, Open Shed 6,  
8000 Jefferson Davis Highway,  
Richmond, VA 23297-5900

#### 4. NOTES:

4.1 If your activity is personally transporting ODS to the DoD ODS Reserve, carriers making deliveries must use only Gate 13, located off State Route 150, Chippenham Parkway, (Exit 67 from I95), 1/4 mile west of U.S. Highway 1 and 301, Strathmore Road/DDR/DSCR Exit, between 8:00 A.M. and 12:00 Noon, Monday through Friday, excluding holidays. (GPS users can enter "Strathmore Road and G Road" to locate this entrance) Carriers should contact Mr. Otis Dowdy for directions or upon arrival at the Depot at Work: 804-279-2821 or Cell: 804-543-4404. Please make sure the material is properly marked, palletized, and banded.

4.2 Current NSNs for cylinders are available from the SUPERVISOR.

4.3 Condition codes for cylinders are as follows:

4.3.1 Condition Code A: To be used for returning original cylinders whose seal was never broken or for recovery cylinders.

4.3.2 Condition Code B: To be used for returning full, original cylinders or for standard DOD refillable cylinders.

4.3.3 Condition Code F: To be used to return partially depleted cylinders whose purity cannot be guaranteed or for returning other (non-standard/commercial) cylinders.

4.4 Definition of Recover - To remove refrigerant in any condition from a system and store it in an external container without necessarily testing or processing it in any way.

ATTACHMENT A

ODS Requiring Turn-In to Defense Reserve in accordance with reference 2.2:

PRODUCT TYPE	PRODUCT TYPE WEIGHT	CYLINDER WATER WEIGHT
R-11	59	42
	170	122
	1,400	1,000
	100 (drum)	N/A
	200 (drum)	N/A
	650 (drum)	N/A
R-12	45	42
	145	122
	1,190	1,000
R-22	44	42
	128	122
	1,050	1,000
R-113	6 ounces	N/A
	1 pint	N/A
	1 quart	N/A
	1 gallon	N/A
	5 gallons (60 lbs)	N/A
	100 lbs (can)	N/A
	200 lbs (drum)	N/A
	55 gallons (drum)	N/A
Methyl Chloroform (1,1,1 Trichloroethane)	6 ounces	N/A
	1 pint	N/A
	1 quart	N/A
	1 gallon (12 lbs)	N/A
	5 gallons (60 lbs)	N/A
	55 gallons (640 lbs)	N/A

Note: Only unused CFC-113 or Methyl Chloroform (1,1,1 Trichloroethane) solvent contained in original drums or cans with unbroken seals shall be returned to DDRV. Used R-113 refrigerant can also be returned. Call (804) 279-5203 or DSN 695-5203 for specific turn-in guidance.

PRODUCT TYPE    PRODUCT TYPE WEIGHT    CYLINDER WATER WEIGHT

R-114	57	42
	165	122
	1,350	1,000
R-500	43	42
	127	122
	1,045	1,000
R-502	44	42
	125	122
	1,050	1,000
H-1202	160	122
H-1211	1-5	
	6-10	
	11-20	
	21-60	
	61-125	
	126-200	122
	200	122
	201-340	
	341-1,500	1,000
1,500	1,000	
H-1301	1-5	
	6-10	
	11-20	
	21-70	
	71-100	
	101-117	
	117	
	118-125	
	126-150	
	150	122
	151-200	
	201-260	
	261-350	
	351-530	
	531-600	
	601-1,240	
1,240	1,000	



NAVSEA  
STANDARD ITEM

FY-24

ITEM NO: 009-87  
DATE: 25 OCT 2022  
CATEGORY: II

1. SCOPE:

1.1 Title: Chemical Disinfection Procedure; accomplish

2. REFERENCES:

2.1 NAVMED P-5010-6, Manual of Naval Preventive Medicine, Chapter 6, Water Supply Afloat

3. REQUIREMENTS:

3.1 Accomplish a chemical disinfection of each affected potable water system (e.g., tank, pump, piping and hoses) in accordance with 2.1.

3.2 Accomplish a halogen (chlorine) residual test for each affected potable water system. Acceptable free available chlorine (FAC) must meet minimum levels specified in 2.1.

3.2.1 Submit one legible copy, in approved transferrable media, of the chlorine residual test to the SUPERVISOR not later than one day after the completion of the test, stating that minimum FAC level has been met in accordance with 2.1.

3.3 Secure and tag out each affected potable water system upon completion of the chlorine residual test.

3.4 Accomplish a bacteriological test for each affected potable water system.

3.4.1 Bacteriological testing must be accomplished at laboratories certified by state regulatory agencies in states having primacy, or by the Regional EPA Office in states not having primacy.

3.4.2 Submit one legible copy, in approved transferrable media, of completed report to the SUPERVISOR not later than one day after the completion of the test, with certification that the water is safe for human consumption.

3.5 Remove each tag upon completion of satisfactory bacteriological test and release each potable water system for Ship's Force use.

3.6 Accomplish chemical localized disinfection of each new and disturbed pipe fitting, pipe end, and valve in accordance with Article 6-22d(2) of 2.1 ensuring, at a minimum, each method is consistent with METHOD 2 of Table 6-2.

3.7 Remove and dispose of chlorinated water and all rinse water in accordance with federal, state, and local laws, codes, ordinances, and regulations.

3.8 Mixing or taking calcium hypochlorite in dry powder form aboard ship is prohibited.

4. NOTES:

4.1 2.1 can be accessed at:

<http://navymedicine.med.navy.mil> (use link to Navy Medicine Directives, Publications and Manuals)

or

<http://www-nehc.med.navy.mil/downloads/prevmed/NewP-5010-6.pdf>

NAVSEA  
STANDARD ITEM

FY-24

ITEM NO: 009-88  
DATE: 25 OCT 2022  
CATEGORY: I

1. SCOPE:

1.1 Title: Collection, Holding and Transfer (CHT) and Motor Gasoline (MOGAS) Tanks, Spaces, and Piping, including Sewage or MOGAS-Contaminated Tanks, Spaces, and Piping; certify

2. REFERENCES:

2.1 Standard Items

2.2 29 CFR Part 1915, Occupational Safety and Health Standards for Shipyard Employment

2.3 NFPA Standard 312, Standard for Fire Protection of Vessels During Construction, Repair, and Lay-up

2.4 NFPA Standard 306, Standard for the Control of Gas Hazards on Vessels

2.5 S9086-T8-STM-010/CH-593, Pollution Control

2.6 Compressed Gas Association Commodity Specification for Air, Pamphlet G-7.1

2.7 29 CFR Part 1910.134, Occupational Safety and Health Standards, Respiratory Protection

3. REQUIREMENTS:

3.1 Certify ENTER WITH RESTRICTIONS, SAFE FOR WORKERS and/or SAFE FOR HOT WORK in accordance with 2.2 through 2.4, using 2.5 and 2.6 for guidance, Collection, Holding and Transfer (CHT) and MOGAS tanks, spaces, and associated piping, and inspect and certify adjacent tanks, spaces, or piping, where the scope of repairs will result in a need for certification during the accomplishment of this Job Order.

3.1.1 A National Fire Protection Association (NFPA) Certified Marine Chemist must be present and personally certify the initial opening or entry of CHT or MOGAS tanks and spaces and the initial opening of associated piping.

3.1.2 Comply with subpart B of reference 2.2 for the reentry of CHT or MOGAS tanks and spaces and reopening of associated piping. Accomplish the requirements of 3.1.1 if the system was restored and opening or entry into the system is required.

3.1.3 Submit one legible copy, in approved transferrable media, of a list of tanks or spaces to be certified to the SUPERVISOR at least one day prior to commencement of work.

3.1.4 Accomplish the requirements of 009-09 of 2.1 to support a step by step procedure of how the certification process will be accomplished.

3.1.4.1 Procedures for CHT systems must include, as a minimum, personnel requirements, notification of emergency response personnel, disinfecting of CHT tank and associated piping, removal of product, diagram and tag-out of affected piping, protective clothing, respiratory protection, ventilation requirements, and a list of spaces affected.

3.1.4.2 Procedures for MOGAS systems must include, as a minimum, personnel requirements, notification of emergency response personnel, removal of product from the draw-off tank and MOGAS tank and associated piping, removal of inert gas (carbon dioxide) from the cofferdam around the MOGAS tank, tag-out of affected MOGAS and inert gas (CO<sub>2</sub>) piping, fire protection/fire prevention, protective clothing, respiratory protection, ventilation requirements, and control of other hazards such as benzene and lead.

3.2 Provide a written notice of opening of CHT and MOGAS tanks, spaces, and associated piping.

3.2.1 Deliver written notification to the SUPERVISOR and the Commanding Officer's designated representative at least 4 hours prior to the planned opening of CHT or MOGAS tanks, spaces, and associated piping.

3.2.2 Deliver written notification to the SUPERVISOR and the Commanding Officer's designated representative of opening of CHT or MOGAS tanks, spaces, and associated piping planned over a weekend or Monday following that weekend no later than 0900 on the Friday immediately preceding that weekend.

3.2.3 Deliver written notification to the SUPERVISOR and the Commanding Officer's designated representative of opening of CHT or MOGAS tanks, spaces, and associated piping planned on a federal holiday and on the day following the federal holiday no later than 0900 of the last working day preceding the federal holiday.

3.3 Accomplish the requirements of 2.2 for tanks, spaces, or piping that have the potential to become Immediately Dangerous to Life or Health (IDLH).

3.3.1 Spaces that are determined to contain IDLH atmospheres must never be entered except for emergency rescue or for short duration for installation of ventilation equipment in accordance with 2.2 and 2.7, and the requirements of 3.3.1.1 and 3.3.1.2. When

entering IDLH spaces for the purpose of installing ventilation, notify the SUPERVISOR prior to entry. Notifications of rescue must be made as soon as possible.

3.3.1.1 Provide a full facepiece, pressure demand, self-contained breathing apparatus (SCBA) certified by National Institute for Occupational Safety and Health (NIOSH) for a minimum service life of 30 minutes, or a combination, full facepiece, pressure demand supplied-air respirator (SAR) with an auxiliary self-contained air supply. The size/volume of the auxiliary self-contained air supply must be based on the contractor's assessment of the unique characteristics/hazards of the space being entered to allow employees to safely escape.

3.3.1.2 In the case of MOGAS tanks and the associated cofferdams, the auxiliary self-contained air supply must be a minimum of 15 minutes or more depending on the required assessment in 3.3.1.1.

3.3.2 NIOSH-approved atmosphere-supplying respirators must be used by personnel entering CHT tanks, MOGAS tanks or spaces, or opening associated piping. Atmosphere-supplying respirators may be either a combination, full facepiece, pressure demand SAR, or a full facepiece, pressure demand SCBA. The source of breathing air for SARs must be either a compressor capable of delivering an adequate quantity of breathing air at the pressure required by the respirators used and meeting the requirements of the specification for Grade D breathing air described in 2.6, or a bank of cylinders cascading to provide at least 4 to 6 hours of breathing air meeting the above specifications at the pressure needed by the respirators used. The source of breathing air for SCBAs must meet the requirements of 2.6. Compressed and liquid oxygen must meet the United States Pharmacopoeia requirements for medical or breathing oxygen. Compressed oxygen must not be used in atmosphere-supplying respirators that have previously used compressed air. SCBA respirators must have a minimum service life of 30 minutes.

3.3.3 All personnel required to use the respiratory equipment mentioned above must receive training in accordance with 2.2 in the actual use of the respirator equipment including operation of all controls and breathing under pressure-demand conditions.

3.3.4 An adequate and attended lifeline must be utilized for each employee who must enter the IDLH or potentially IDLH atmosphere.

3.4 An observer, whose only duty must consist of oversight of the work area and spreading the alarm in the event of a casualty, must be stationed at the access to the work site. The observer must be able to have visual contact or communication with persons in the space at all times.

3.4.1 The observer must be provided with and trained to use the same personal protective equipment required for the personnel accomplishing the work. In addition, the observer must be knowledgeable in the work process being accomplished.

3.4.2 The observer must establish communication between the ship's designated 24-hour manned casualty control location, e.g., Quarterdeck, Damage Control Center (DCC), Casualty Control Station (CCS), and the observer's location to facilitate notification of the ship in the event of a casualty. This communication may be in the form of 2-way radios, temporary portable-wired alarm system, or other effective devices. The communication devices must be tested every 30 minutes, as a minimum, to ensure the observer's ability to sound the alarm in the event of a casualty.

3.5 Ventilation suckers, suction ducting, tools, flashlights, and other equipment must be non-sparking type.

4. NOTES:

4.1 Booklet of General Plans and Tank Sounding Tables are available for review at the office of the SUPERVISOR.

4.2 Refer to 009-07, or 009-70 of 2.1, as appropriate, for other requirements concerning confined space entry, certification, fire prevention, and housekeeping.

4.3 For the purpose of this Standard Item, the words "associated piping" means any piping or fixture physically connected to the CHT or MOGAS system.

NAVSEA  
STANDARD ITEM

FY-24

ITEM NO: 009-90  
DATE: 25 OCT 2022  
CATEGORY: II

1. SCOPE:

1.1 Title: Technical Representative; provide

2. REFERENCES:

2.1 None.

3. REQUIREMENTS:

3.1 Provide the services of a qualified on-site Technical Representative to provide assistance in the process or processes, including NAVSEA pilot coating system application, and repair and testing of the equipment specified in the invoking Work Item. The NSI 009-90 Technical Representative will only be contracted by the prime contractor and the same company cannot provide both the Technical Representative and perform the actual production work.

3.1.1 When an OEM-authorized service provider is subcontracted to accomplish production work associated with a Work Item, section 3.2 through 3.6 of this Standard Item do not apply.

3.1.1.1 Submit, in approved transferable media, one copy of a report notifying the SUPERVISOR of the contractor's exercise of 3.1.1 and identifying the OEM-authorized service provider. Provide certification from the OEM to the SUPERVISOR that the vendor is an OEM-authorized service provider.

3.1.2 Off-facility refurbishment or overhaul of component parts or equipment subject to this standard item may be subcontracted to the same company providing the Technical Representative.

3.2 The Technical Representative must meet the following minimum qualification requirements:

3.2.1 Have technical knowledge of the specified equipment or process and have a documented history of successful performance or repairs on similar equipment or processes.

3.2.2 Have demonstrated competency in analyzing repair requirements and process performance and making recommendations based on process or disassembly inspection results.

3.2.3 Have current/active documented and verified access to Original Equipment Manufacturer (OEM) proprietary plans, specifications, procedures, material, parts, special tools, and equipment.

3.2.4 Provide certification from the OEM or the SUPERVISOR that the individual is an authorized service provider.

3.2.5 Submit one legible copy, in approved transferrable media, of the name and qualifications of the Technical Representative to the SUPERVISOR for approval 15 days prior to commencement of work. Qualification documentation must include information supporting the requirements of 3.2.1 through 3.2.4.

3.2.5.1 Obtain written approval from the SUPERVISOR prior to substituting the Technical Representative.

3.3 The Technical Representative must review, sign, and date all required reports, for technical adequacy prior to submittal to the SUPERVISOR for acceptance. Associated Process Control Procedures must be reviewed, signed, and dated by the Technical Representative prior to the start of work.

3.4 The Technical Representative does not have the authority to direct modifications to the equipment, processes, or items specified in the invoking Work Item or deviate from the Work Item without signed authorization from the SUPERVISOR.

3.4.1 The Technical Representative has the responsibility to notify the SUPERVISOR and recommend interruption of the execution of any specific Work Item if they recognize that repair procedures (e.g., PCP, etc.) are ineffective, the Executing Activity is not following the repair procedures, or not using good craftsmanship practices.

3.5 Minimum requirements for the services of the Technical Representative are as follows:

3.5.1 Witness pre-repair operational tests, adjustments, and inspections to determine equipment condition, when required by the Work Item.

3.5.2 Inspect equipment and component parts during disassembly, to include process material and process performance.

3.5.3 Verify each process document where an as-found report is required, to include clearances and conditions, and submit as-found report. Include in each as-found report the information required by 3.5.3.1 through 3.5.3.4.

3.5.3.1 Provide dimensional measurements and comparisons to minimum/maximum design tolerances for equipment.

3.5.3.2 Provide sketches of suspect and defective areas with notations to describe defects.

3.5.3.3 Provide list of recommended repair parts or material in addition to those specified in the invoking Work Item.

3.5.3.4 Provide recommendations for future process improvements.

3.5.3.5 Provide required special tools and equipment in addition to those specified in the invoking Work Item.

3.5.4 Inspect new and repaired areas and component parts of the equipment prior to assembly to ensure compliance with Navy technical manual requirements and Standard Items.



3.5.4.1 Any deviations or departure from the specifications and/or the requirements of 3.5.4 require an approval from the SUPERVISOR prior to equipment assembly.

3.5.5 Inspect and provide technical guidance and assistance during process performance, equipment assembly and adjustment, and when specified, coating application. Verify assembly procedures, sizes, and clearances comply with manufacturer's requirements, Navy technical manual requirements, and coating application procedures when specified.

3.5.5.1 Verify and document mechanical and electrical alignments, final closing sizes, and clearances.

3.5.6 Witness operational tests, make adjustments, and document test and process performance results, including, when required, final inspections of coating systems.

3.5.7 Submit one legible copy, in approved transferrable media, of a report listing overall condition to the SUPERVISOR within 5 days of completion of the requirements of the Work Item and/or coating system application or other process specified in the invoking Work Item.

3.5.7.1 The report must provide a brief of the repairs accomplished and the Technical Representative's assessment of the post-overhaul equipment condition or process performance.

3.6 Notify the SUPERVISOR upon initial arrival and prior to final departure of the Technical Representative.

4. NOTES:

4.1 None.

NAVSEA  
STANDARD ITEM

FY-24

ITEM NO: 009-91  
DATE: 25 OCT 2022  
CATEGORY: II

1. SCOPE:

1.1 Title: Propeller In-Place Inspection; accomplish

2. REFERENCES:

2.1 S9086-HP-STM-010/CH-245, Propellers and Propulsors

3. REQUIREMENTS:

(I) "VISUAL INSPECTION"

3.1 Clean and accomplish a visual inspection of each propeller and propeller cap in accordance with Section 3 of 2.1.

3.2 Record all inspection data taken in 3.1.

3.2.1 Submit one legible copy, in approved transferrable media, of completed Propeller Visual Technical Inspection Report Forms, NAVSEA 9245/3, listing results of the visual inspection and a sketch showing the size and location of any cracks or defects to the SUPERVISOR.

3.2.2 Cover the entire periphery of each propeller blade with metal edge guards and secure them with steel straps in accordance with 2.1.

3.3 Stake each screw and plug on the exterior of each propeller cap to prevent backing out.

(V) "INSPECT BLADE ALIGNMENT"

3.4 Inspect for the existence and accuracy of the word "BLADE" in line with each propeller blade on the coupling flange at the main reduction gears.

3.4.1 Stamp coupling hub with the word "BLADE" in line with each propeller blade. Stamping must be 1/8-inch to 1/4-inch lettering, low stress markings. Etching is prohibited.

3.5 Just prior to undocking, remove blade edge protection installed in 3.2.2.

(V) "INSPECT BLADE EDGE PROTECTION REMOVAL"

3.5.1 Inspect to ensure that blade edge protection has been removed.

4. NOTES:

4.1 Additional inspections or requirements will be specified in invoking Work Item.

4.2 NAVSEA Form 9245/3 is available on the Web at:

<http://www.dema.mil/NPP/forms.aspx>

NAVSEA  
STANDARD ITEM

FY-24

ITEM NO: 009-92  
DATE: 25 OCT 2022  
CATEGORY: II

1. SCOPE:

1.1 Title: Resilient Mount; install

2. REFERENCES:

2.1 Standard Items

2.2 Equipment Technical Manual

2.3 S9073-A2-HBK-010, Installation and Inspection Information Resilient Mount Handbook

3. REQUIREMENTS:

3.1 Inspect for the presence of heavily mis-loaded or deformed mounts prior to mount removal using 2.2 and 2.3 for guidance.

3.1.1 Submit one legible copy, in approved transferrable media, of heavily mis-loaded or deformed mounts to the SUPERVISOR within 3 days of identifying the condition.

3.2 Remove resilient mount assemblies, using 2.2 and 2.3 for guidance.

3.2.1 Inspect each equipment foundation for structural integrity, deterioration, pitting, cracks, and areas of damage or distortion.

3.2.1.1 Submit one legible copy, in approved transferrable media, of a report listing results of the requirements of 3.2.1 to the SUPERVISOR within 5 days after equipment removal.

3.2.2 Accomplishment of cleaning and painting for disturbed surfaces of each foundation where resilient mount assemblies have been removed must be in accordance with NAVSEA Standard items (See Note 4.3).

3.3 Select, procure, assemble, install, load, and adjust new resilient mount assemblies including load bolts, foundation bolts, nuts, and snubbers in accordance with 2.3.

3.3.1 Stamp the installation date on each resilient mount flange adjacent to the identification date. The date must be visible and legible when the mount is installed with 1/8-inch minimum lettering size.

3.3.2 Submit one legible copy, in approved transferrable media, of a report listing results of the requirements of 3.3 and 3.3.1 to the SUPERVISOR. The report must include the following:

3.3.2.1 Identity of equipment

3.3.2.2 Amount and designation of mounts installed

4. NOTES:

4.1 Equipment technical manual and drawings referenced in invoking Work Item may identify mount designation and loading requirements.

4.2 This item does not apply to turbine enclosure mounts.

4.3 If cleaning and painting for disturbed surfaces of each foundation where resilient mount assemblies have been removed of 3.2.2 is required; the use of Category II Standard Item 009-32 "Cleaning and Painting Requirements; accomplish" of 2.1 will be specified in the Work Item.

NAVSEA  
STANDARD ITEM

FY-24

ITEM NO: 009-93  
DATE: 25 OCT 2022  
CATEGORY: I

1. SCOPE:

1.1 Title: Emergency Planning and Community Right-to-Know Act (EPCRA) and Pollution Prevention Act (PPA) Information; provide

2. REFERENCES:

2.1 42 U.S.C. 110001, et seq (1986) Emergency Planning and Community Right-to-Know (EPCRA)

2.2 Comprehensive Environmental Response, Compensation, and Liability Act of 1980 (CERCLA), Section 102(a)

2.3 40 CFR Parts 300, 302, 355, 370, and 372, Protection of Environment

2.4 OPNAV M-5090.1, Environmental Readiness Program Manual

3. REQUIREMENTS:

3.1 Contractor facility availabilities:

3.1.1 Designate a primary and secondary point of contact to receive reports /notifications from the SUPERVISOR applicable under this item.

3.1.1.1 These reports/notifications will include quantities of hazardous substances stored or accidentally released by Government activities in accordance with Sections 302, 304, 311, 312, and 313 of 2.1. In accordance with 2.4, material maintained under the ship's custody is not subject to the reporting requirements of 2.1 (See Note 4.1).

3.1.2 Submit the names of the primary and secondary point of contact to the SUPERVISOR in writing prior to availability start date.

3.2 Government facility availabilities:

3.2.1 Provide reports/notifications required in 3.2.2 through 3.2.6.2 to the SUPERVISOR regardless of threshold quantities delineated in 2.1 through 2.3.

3.2.2 EPCRA Section 302 requirements:

3.2.2.1 Submit one legible copy, in approved transferrable media, of Safety Data Sheet (SDS) for each Extremely Hazardous Substances (EHS) listed in 2.3 brought aboard the Government facility.

3.2.2.2 Report quantities of all chemical products containing EHS brought aboard the Government facility.

3.2.3 EPCRA Section 304 requirements:

3.2.3.1 Provide verbal notification of the release of a reportable quantity of an EHS or Hazardous Substance (HS) released at the Government facility to the SUPERVISOR immediately after initial applicable notifications have been made in accordance with local regulations. This verbal notification must be followed by a written notification to the SUPERVISOR within one day.

3.2.4 EPCRA Section 311 requirements:

3.2.4.1 Provide SDS and quantity (by weight) of each HS and EHS in accordance with 2.3, stored on the Government facility.

3.2.5 EPCRA Section 312 requirements:

3.2.5.1 Provide SDS and Tier I and Tier II reports, including quantities processed or used, of all products or substances listed in accordance with 2.3.

3.2.6 EPCRA Section 313 requirements:

3.2.6.1 Provide SDS and quantities processed or used of all products or substances listed in Section 313 lists in accordance with 2.3.

3.2.6.2 The Standard Industrial Classification (SIC) Code exception for reporting under Section 313 of 2.1 must be disregarded when making the required reports.

3.3 All availabilities:

3.3.1 Submit one legible copy, in approved transferrable media, of non-emergency reports and copies of SDS(s) to the SUPERVISOR upon request.

3.3.2 All emergency reports must be made immediately upon becoming aware of the existence of the release.

3.3.3 Utilize individual contract numbers on all reports/ notifications.

4. NOTES:

4.1 None.

NAVSEA  
STANDARD ITEM

FY-24

ITEM NO: 009-95  
DATE: 25 OCT 2022  
CATEGORY: II

1. SCOPE:

1.1 Title: Mechanically Attached Fitting (MAF); install

2. REFERENCES:

2.1 MIL STD 777, Schedule of Piping Systems, Valves, Fittings, and Associated Piping Components for Naval Surface Ships

2.2 S9086-RK-STM-010/CH-505, Piping Systems

3. REQUIREMENTS:

3.1 Provide control over the use of mechanically attached fittings (MAFs) when approved in accordance with 4.46 of 2.1 as an alternative to the standard welding or brazing of fittings in shipboard piping systems. Select and install MAFs in accordance with Paragraph 505-6.8 of 2.2.

3.2 Prepare a written procedure for approval by the SUPERVISOR identifying the specific MAF process that may be utilized. The procedure requires a one-time submittal/acceptance unless Standard Items and/or references change or contractor's status changes.

3.2.1 The procedure must be in accordance with 2.2 and must include quality control requirements, inspection and documentation forms, safety requirements, installation criteria (procedures), responsibilities, and training program requirements.

3.2.2 Submit one legible copy, in approved transferrable media, of the procedure to the SUPERVISOR at least 7 days prior to initial implementation of procedure.

3.2.2.1 Submit updated or changed procedures to the SUPERVISOR at least 3 days prior to implementation.

3.3 Accomplish the requirements of the approved procedure.

3.3.1 Submit one legible copy, in approved transferrable media, of a report to the SUPERVISOR identifying the type of MAF, location (space), and system where the contractor exercises the option to install MAFs in lieu of weld fittings.

4. NOTES:

4.1 None.



NAVSEA  
STANDARD ITEM

FY-24

ITEM NO: 009-96  
DATE: 25 OCT 2022  
CATEGORY: II

1. SCOPE:

1.1 Title: Ball Valve; repair

2. REFERENCES:

2.1 S9086-RJ-STM-010/CH-504, Pressure, Temperature and Other Mechanical and Electromechanical Measuring Instruments

3. REQUIREMENTS:

3.1 Matchmark valve parts.

3.2 Disassemble, clean each internal and external surface free of foreign matter (including paint), and inspect each part for defects.

3.3 Repair valve as follows:

3.3.1 Polish the seating surface of the valve ball to a 32 Root-Mean-Square finish to remove high spots, nicks, and burrs.

3.3.2 Remove each existing and install new valve soft seats using those compatible with the system fluid, in accordance with manufacturer's specifications.

3.3.3 Chase and tap exposed threaded areas.

3.3.4 Dress and true gasket mating surfaces.

(I)(G) "VERIFY LEVEL I PARTS AND CLEANLINESS"

3.4 Assemble each valve installing new each packing, each gasket, each diaphragm, each spring, and each soft seat, and each fastener, for those removed in 3.2 in accordance with the manufacturer's specifications or instruction.

3.4.1 Lubricate each MIL-PRF-24509 valve with grease conforming to SAE-AMSG-6032.

(I) or (V) "INSPECT ALIGNMENT" (See 4.3)

3.5 Inspect alignment of ports in the ball valve and body with the ball fully seated. Ball misalignment must not be of a degree that will restrict flow.

3.6 Hydrostatically test valve as follows:

3.6.1 Hydrostatic test equipment must have the following capabilities:

3.6.1.1 Manual overpressure protection release valve.

3.6.1.2 Self-actuated and resetting relief valve with a set point no greater than 100 PSIG above the test pressure or 10 percent above the test pressure, whichever is less.

3.6.1.3 Master and backup test gauges with gauge range and graduation in accordance with Table 504-6-1 of 2.1. The backup gauge must be cross-checked to the master hydrostatic test gauge up to the maximum test pressure just prior to start of testing. Master and backup gauges must track within 2 percent of each other.

3.6.1.4 Protection equipment must be accessible and test gauges must be located where clearly visible and readable to pump operator and inspector.

(V)(G) or (I)(G) "SEAT TIGHTNESS" (See 4.4)

3.6.2 Test for seat tightness alternately on each side of ball valve with the opposite side open for inspection.

3.6.2.1 Ball must be seated by hand force.

3.6.2.2 Test must be continued for a minimum of 3 minutes if there is no evidence of leakage or, in the event of visible leakage, until accurate determination of leakage can be made.

3.6.2.3 Allowable leakage for a soft-seated ball valve: None.

#### 4. NOTES:

4.1 Test pressures of 3.6.2 will be specified in Work Item.

4.2 Repair of valve operating gear will be specified in Work Item.

4.3 The paragraph referencing this note is considered an (I) if the valve is Level I. If the valve is not Level I, the paragraph is considered a (V).

4.4 The paragraph referencing this note is considered an (I)(G) if the valve is Level I. If the valve is not Level I, the paragraph is considered a (V)(G).

4.5 Test medium will be specified in Work Item.

NAVSEA  
STANDARD ITEM

FY-24

ITEM NO: 009-99  
DATE: 25 OCT 2022  
CATEGORY: I

1. SCOPE:

1.1 Title: Ship Departure Report; provide

2. REFERENCES:

2.1 None.

3. REQUIREMENTS:

3.1 Provide the following completion data, which will be used to close all completed 2-Kilos and generate the Ship Departure Report, no later than 60 days after the availability end date for scheduled CNO and scheduled Fleet Maintenance Availabilities and no later than 60 days after completion of the work for unscheduled and emergent Fleet Maintenance Availabilities. Provide this data in the Navy Maintenance Database (NMD), either directly in the application or indirectly via another computer system using a web interface.

3.1.1 Verify that the following fields are correct: Execution Availability, Contractor, Definitized Amount, Contract Number, Availability Start Date, and Availability End Date.

3.1.2 Verify that the following Work Item fields are correct for each Work Item completed in the work package: SPEC and RCC.

3.1.3 For COST contracts, provide the following data for each Work Item and Request for Contract Change (RCC) completed in the work package: M/D, LABOR, CFM, subcontractor information, COMPLETION DATE, ACTION TAKEN code (see 4.2), and AS FOUND CONDITION (if required by the Work Item).

3.1.3.1 Return cost data must be entered separately for each Original Work Item and RCC. The RCC costs are those costs associated with a change in scope from the Original Work Item. The Original Work Item costs plus all associated RCC costs must equal the actual costs from the C+60 Final Cost Report or equivalent financial report for that completed Work Item. If the contractor is unable to segregate charges between Original Work Items and RCCs, it is acceptable to report RCC settled costs (M/D, LABOR, CFM, and subcontractor information) as the return costs for the

RCC, and to subtract the settled costs of all RCCs for the Work Item from the total Work Item actual costs to derive the return costs associated with the Original Work Item.

3.1.3.2 The sum of all Work Items, including all RCC costs and new Work Items, must equal the actual cost of the availability without fees from the C+60 Final Cost Report or equivalent financial report.

3.1.4 For FFP contracts, provide the following data for each Work Item and Request for Contract Change (RCC) completed in the work package: COMPLETION DATE, ACTION TAKEN code (see 4.2), and AS FOUND CONDITION (if required by the Work Item).

3.2 For COST contracts, verify the subcontractor percentages are correct or adjust as necessary. (See 4.3)

3.3 Report completion to the SUPERVISOR.

#### 4. NOTES:

4.1 Departure reports are not accounting documents; however, they will be handled as business sensitive material once filled out. Mark with the appropriate CUI markings.

4.2 Definitions for Action Taken codes can be found in NAVSEAINST 4790.8, Paragraph B-2.5.2.

4.3 If the distribution of subcontractor information is known, enter the data in the appropriate fields (SUB-M/D, SUB-LABOR, and SUB-MAT). If only a total cost of subcontracted work is known, enter that cost in the SUB-MAT field and leave SUB-M/D and SUB-LABOR blank.

4.4 For non-alteration Work Items and RCCs, if only GFM was used, enter an ACTION TAKEN Code of 1 (Maintenance Action Completed; Parts Drawn From Supply). If only CFM was used, enter an ACTION TAKEN Code of 2 (Action Complete; Parts Not Drawn From Supply). If no material was required, enter an ACTION TAKEN Code of 3 (Action Complete; No Parts Required). If both GFM and CFM were used, enter an ACTION TAKEN Code of 1 (Maintenance Action Completed; Parts Drawn From Supply).

4.5 Attachment A defines terms used in this Standard Item.

4.6 For activities not using NMD, Attachments B and C are provided as examples of the required format for departure reports. (See 4.1)

## ATTACHMENT A

### GLOSSARY

**ACTION TAKEN CODE:** Code which describes the final disposition of the Work Item/RCC

**AS FOUND CONDITION:** Code which describes the necessity of the Work Item/RCC

**AVAILABILITY END DATE:** Date of actual availability completion (month/day/year)

**AVAILABILITY START DATE:** Date of actual availability start (month/day/year)

**CFM:** Contractor-furnished material cost

**CONTRACT NUMBER:** Identifying number of the contract authorizing the work

**CONTRACTOR:** Name of contractor

**DEFINITIZED AMOUNT:** Contract price plus growth pool

**EXECUTION AVAILABILITY:** Number assigned to the availability, showing contractor, SPP (code to describe the availability type and contract method), and the fiscal year of execution

**GFM:** Government furnished material cost

**JCN:** The 5-digit ship UIC plus the 8-character Job Sequence Number

**LABOR:** Cost for contractor labor

**M/D:** Man-days; contractor man-hours divided by 8

**ORIGINAL WORK ITEM:** A Work Item that existed at definitization/award. It is the original scope of work for that work Item

**RCC:** Request for contract change

**SETTLED WORK ITEM:** The estimated costs (M/D, LABOR, CFM, and subcontractor information) at the time the RCC is settled

**SPEC:** Work Item

**SUB-LABOR:** Cost for subcontractor labor (if known)

**SUB-MAT:** Subcontractor-furnished material cost (or total subcontractor cost if SUB-M/D, SUB-LABOR, and SUB-MAT are not known)

**SUB-M/D:** Subcontractor man-days; subcontractor man-hours divided by 8 (if known)

TYPE AVAIL: The type of availability. Examples: ROH - Regular Overhaul; COH - Complex Overhaul; SRA - Selected Restricted Availability; DSRA - Docking Selected Restricted Availability; PMA - Phase Maintenance Availability; DPMA - Docking Phase Maintenance Availability; INA - Inactivation; ACT - Activation; CONV - Conversion; CMAV - Continuous Maintenance Availability; PSA - Post Shakedown Availability; PIA - Planned Incremental Availability; DPIA - Docking Planned Incremental Availability; RCOH - Refueling Complex Overhaul



ATTACHMENT C  
(See NOTES 4.1 of 009-99)  
SHIP DEPARTURE REPORT

NAVSEAINST 4790.14 Series

REPORT NO: \_\_\_\_\_

ISSUE DATE: \_\_\_\_\_

SHIP/HULL  
SSP NO.  
UIC  
FY/TYPE AVAIL.  
AVAIL.NO.  
AVAIL. START  
AVAIL. COMPLETION  
INDUSTRIAL ACTIVITY  
CONTRACTOR  
JOB ORDER NO.

CUSTOMER/  
TYPE OF WORK      COAR      M/D RATE      GLM      M/D      MAT'L      COST      APA  
TYCOM REPAIRS

TYCOM ALTERATIONS

NAVSEA ALTERATIONS

NAVSEA ORDALTS

ADMINISTRATIVE SERVICES  
(DSA FUNDED)

OTHER

TOTALS



NAVSEA  
STANDARD ITEM

FY-24

ITEM NO: 009-100  
DATE: 25 OCT 2022  
CATEGORY: I

1. SCOPE:

1.1 Title: Ship's Stability; maintain

2. REFERENCES:

2.1 Standard Items

2.2 T9070-AF-DPC-010/079-1, Design Practices and Criteria for U.S. Navy Surface Ship Stability and Reserve Buoyancy

2.3 541-6687001, Compensating Fuel Oil Tanks on CG-47 Class Ships, Guidance for Process Control Procedure While Waterborne

2.4 541-6686789, Compensating Fuel Oil Tanks on DDG-51 Class Ships, Guidance for Process Control Procedure Preparation While Waterborne

2.5 S9541-BF-OMI-010, LHD Oil Compensating System SCD 3263

2.6 S9LHA-AF-SIB-070, LHA 6 USS AMERICA, Ship Information Book, Volume 2, Part 2, Lubricating Oil, Ship Fuel, Aviation Fuel and Gasoline, Chapters 17 through 19.

3. REQUIREMENTS:

3.1 Perform Engineering Calculations to ensure ship's stability for all surface ships is maintained throughout the duration of an availability using the following criteria: Calculations to be provided to Government upon request.

3.1.1 Stability Criteria as defined in Para 6.1.1.2 and 8.1.9 of Ref 2.2.

3.1.1.1 Add and remove solid weight or water to maintain the ship's stability.

3.1.2 The ship's list must not exceed 2 degrees.

3.1.2.1 List exceeding 2 degrees, shall be corrected within 4 hours.

3.1.2.2 Corrective action to compensate for excessive list includes providing solid weights or water boxes at the locations and amounts determined by the Engineering Calculations.

3.1.2.3 Mitigations to control excessive list will not violate stability criteria noted in paragraph 3.1.

3.1.2.4 For CG-47 class vessels, refer to 009-118 of ref 2.1 for the placement of weights.

3.1.3 The ship's transverse metacentric height (GM), corrected for the liquid load free surface moment of transference, shall meet the following requirements for all conditions of loading throughout the availability:

3.1.3.1 For CG-47 class vessels only, transverse GM shall be greater than or equal to 1.5 feet.

3.1.3.2 For all other naval surface ships, the transverse GM derived from Engineering Calculations shall be greater than or equal to either 1.0 foot or the ship's Lightship Loading Condition transverse GM, whichever is greater.

3.2 For ships that have fuel/oil compensating systems dewatering of the compensated fuel oil will be in accordance with the following references:

3.2.1 For CG 47 class vessels Ref 2.3

3.2.2 For DDG 51 class vessels Ref 2.4

3.2.3 For LHD 1-8 Ref 2.5

3.2.4 For LHA 6 class Ref 2.6

3.3 For CG 47 and DDG 51 Class Ships only, submit the Process Control Procedure (PCP) in accordance with 009-09 of Ref 2.1 to the SUPERVISOR:

- Within 10 business days prior to start of availability for CNO scheduled availabilities;
- Within 5 business days after award for non-CNO availabilities; and
- Within 5 business days of any contract change order authorizing work that will alter the ship's condition of stability and after that, updated at a minimum of once every 30 days,

3.3.1 The PCP must be updated to ensure stability criteria denoted in Requirements Paragraphs 3.1 and 3.2 are satisfied prior to the execution of work if conditions not evaluated in Engineering Calculations are presented during the availability, including but not limited to:

3.3.1.1 Work-sequencing results in onloads above or removals below the Full Load Condition KG equivalent to a draft change greater or equal to 1/4th inch. For ships that use the metric system this value will be 1 cm.

3.3.1.2 Adding/removing shrouding, or other increase/decreases in sail area.

3.3.1.3 If it is found that ship will not meet stability or list criteria, provide recommendations to mitigate.

3.3.2 The PCP must contain the following information:

3.3.2.1 Ship's name and hull number.

3.3.2.2 The number and revision of all drawings, hydro static curves of form and cross curves of stability, trim and stability books, and other source material used in the Engineering Calculations.

3.3.2.3 Copy(s) of the page(s) from the source document(s) that show the Lightship Condition used in the engineering calculations. The copies must show the number and revision of the source document(s).

3.3.2.4 Copy(s) of the fuel and water report and/or sounding report used for determining the ship's liquid load in the Engineering Calculations. The report must be signed, dated and must be annotated to indicate whether the liquid level was determined manually or via Tank Level Indicator (TLI).

3.3.2.5 Engineering Calculations Complete, detailed, including all assumptions, the results of the calculations, and the accept/reject criteria.

3.4 A new Engineering Calculation/PCP must be developed for each invocation of this Standard Item. The use of a calculation/PCP developed for another ship and/or the use of a PCP developed for the same ship from a previous availability is prohibited.

#### 4. NOTES:

4.1 Compliance with Paragraph 3.0 requirements will require access to the ship's Damage Control Book, curves of form and cross curves of stability, docking drawing, tank sounding tables, and/or tank capacity curves may be required. Some or all of these documents may be classified, export controlled, and/or NOFORN depending upon the ship class. The performing activity will advise the Supervisor of their standing authorization to handle controlled information up to the level required to develop Engineering Calculations required herein.

4.2 Attachment A of 009-103, the Weight Control NSI, can be adapted to support gathering required information to accomplish requirements of 3.0. Not all fields will be required.

NAVSEA  
STANDARD ITEM

FY-24

ITEM NO: 009-101  
DATE: 25 OCT 2022  
CATEGORY: I

1. SCOPE:

1.1 Title: Ship Transit and Berthing; accomplish

2. REFERENCES:

2.1 Standard Items

2.2 845-6686999, US Navy Vessel Water Depth, Mooring and Hull/Appendage Clearance Requirements for Transit and Berthing

3. REQUIREMENTS:

3.1 For all non-Aircraft Carrier ships over 100 feet in length at a contractor facility, channels, berth, and turning basin must comply with 2.2.

3.1.1 Minimum water depth must be maximum navigable draft plus 2 feet at mean low water.

3.1.1.1 The approach channel, vessel turning radius, and berth/pier must be clearly marked with channel markers in areas where the 2 feet minimum does not extend beyond the minimum approach channel, vessel turning radius, and berth/pier requirements specified in 2.2.

3.1.1.2 Install temporary fixed reference points at each end of the approach channel and berth. The reference points must mark the center of the approach channel and berth.

3.2 Maintain a minimum of 4 feet between the highest point on the ship and overhead projections at mean high water.

3.3 Maintain a minimum horizontal clearance of 17 feet 6 inches between each side of the ship's extreme beam (35 feet total) and any fixed structures such as bridges.

3.4 Submit one legible copy, in approved transferrable media, of a report listing results of the requirements of 3.1 through 3.3 to the SUPERVISOR 15 days prior to availability start date.

4. NOTES:

4.1 This item is for all ships over 100 feet in length entering contractor's facility.

4.2 Mooring requirements are prescribed in 009-69 of 2.1.

NAVSEA  
STANDARD ITEM

FY-24

ITEM NO: 009-103  
DATE: 25 OCT 2022  
CATEGORY: II

1. SCOPE:

1.1 Title: Weight and Moment Change Data; provide

2. REFERENCES:

2.1 S9086-C6-STM-010/CH-096, Weights and Stability

3. REQUIREMENTS:

3.1 Provide final weight and moment data in the format identified in Attachment A.

3.1.1 Maintain an account of weight and moment changes resulting from work accomplished during the availability in accordance with 2.1 as follows:

3.1.1.1 Weights removed and location of removal

3.1.1.2 Weights added and location of addition

3.1.1.3 Longitudinal, vertical, and transverse moment of removed weights

3.1.1.4 Longitudinal, vertical, and transverse moment of added weights

3.1.2 Submit one legible copy, in approved transferrable media, of a report listing results of the requirements of 3.1.1 to the SUPERVISOR.

3.1.2.1 The data must be a summation of total weight and moment (longitudinal, vertical, and transverse) changes resulting from weights added, removed, and relocated during the availability.

3.1.2.2 Submit a separate data sheet for each applicable Work Item number.

3.1.2.3 Submissions must be progressive as Work Items are completed.

4. NOTES:

4.1 The SUPERVISOR will provide the Alteration Installation Team (AIT), Ship's Force, Commercial Industrial Services (CIS), and Fleet Maintenance Activity (FMA) availability data required in 3.1.



NAVSEA  
STANDARD ITEM

FY-24

ITEM NO: 009-104  
DATE: 25 OCT 2022  
CATEGORY: II

1. SCOPE:

1.1 Title: Vibration Testing and Analysis; accomplish

2. REFERENCES:

2.1 S9073-AX-SPN-010/MVA, Vibration Analysis, Machinery

2.2 Equipment Technical Manual

3. REQUIREMENTS:

3.1 Minimum personnel qualifications:

3.1.1 For vibration testing, personnel must have the equivalent of 1,000 man hours of combined experience in: vibration concepts and terminology, the use of vibration equipment, performing equipment calibration, using electronic data collectors for monitoring and recording of vibration data, the attachment of transducer mounting disks and blocks, the selection and location of transducers, calculating machine frequencies, and have a qualified Vibration Category I certification from the Vibration Institute, or equivalent experience and training.

3.1.2 For vibration analysis, personnel must have the equivalent of 3,000 man hours experience in: the use of FFT analyzers and data collectors, identifying machinery faults, performing spectral analysis, performing vibration testing, and have a knowledge of the engineering units involved, have a qualified Vibration Category II certification from the Vibration Institute, or equivalent experience and training.

3.1.3 Submit one legible copy, in hard copy or approved transferrable media, of written substantiation of the credentials of the personnel to the SUPERVISOR 7 days prior to the start of vibration testing.

3.1.3.1 Submit any change of certification and/or personnel as it occurs to the SUPERVISOR.

3.2 Accomplish vibration testing and analysis of the equipment in accordance with 2.1, using the ship's applicable Vibration Test and Analysis Guide (VTAG), and the following.



3.2.1 Test the equipment at normal operational speed and load, using 2.2 for guidance. Commence vibration testing upon satisfactory completion of shipboard operational testing.

3.2.2 Vibration data must be recorded after obtaining stabilized bearing temperatures for continuous duty equipment.

3.2.2.1 Prior to collecting any data, operate pumps with electric motor drivers a minimum of 4 hours.

3.2.2.2 Operate pumps with auxiliary turbine drivers a minimum of 2 hours.

3.2.2.3 Operate other equipment a minimum of one hour.

3.2.2.4 For auxiliary turbine drivers or other variable speed equipment, data must be acquired within plus or minus 5 percent of the specified speed.

3.2.3 Intermittent or special duty equipment must have vibration data collected during the normal operating cycle.

3.2.4 Acceptable vibration data results must not exceed like unit average machine values (statistically averaged signatures maintained in the ship's/Class program database). New or newly overhauled units must be compared to the Mean plus one Standard Deviation of the statistically averaged machine data as criteria. If only one component, the driver or the driven component, was replaced or overhauled and no repair action was accomplished to the other, the unit vibration signature must be compared to the Mean plus 2 Standard Deviations of the statistically averaged machine data as criteria.

3.2.5 If VTAG information is not available, collect and analyze vibration data in accordance with the following:

3.2.5.1 Record vibration data in accordance with Paragraph 3.1.2 and 3.3 of 2.1.

3.2.5.2 Vibration data must not exceed the criteria of Paragraph 3.4.3 of 2.1.

3.2.5.3 Test equipment in accordance with 3.2.1 through 3.2.3.

3.2.5.4 For reciprocating machinery, take a minimum of 2 data points, one at each end of the crankshaft centerline, or as close to centerline as possible.

3.2.5.5 Number each vibration measurement location, starting on the driver end furthest from the driven unit. For 2 drivers on a single driven unit, the numbering

must be from one driver end to the other. For 2 driven units from a single driver, the numbering must be from one driven unit to the other.

3.2.5.6 Provide a sketch of the unit with the following information:

Drive Unit(s)  
Driven Unit(s)  
Location of Bearings  
Location and numbering of vibration measurement points

3.2.5.7 Scale vibration amplitudes on plot to show the best representation of the magnitudes.

3.2.5.8 For machinery consisting of a drive and driven unit, take vibration data on both pieces of equipment, even if only one piece of equipment was subject to overhaul, to allow a complete analysis of the vibration data, including vibration transmitted between the pieces of equipment.

3.2.6 Record results of vibration analysis on a test data sheet, Attachment A.

3.2.6.1 Submit one legible copy, in hard copy or approved transferrable media, of the following to the SUPERVISOR within 2 days of completion of vibration analysis:

Completed Attachment A  
Machine's vibration data plots  
VTAG applicable to the machine  
Average machine values applicable to the machine

#### 4. NOTES:

4.1 Equipment performance must satisfy vibration requirements of specific average machine values if the machinery item is included in the ship's machinery vibration analysis (MVA) program. Such programs are in compliance with 2.1 and depend on the ship's applicable VTAG to identify machinery, provide pertinent measurement locations, numbering conventions, test conditions, manufacturer's configuration information, analysis ranges and major forcing frequencies.

4.2 For surface ships, other than aircraft carriers, VTAG and average machine values are available from Technical Points of Contact (TPOCs) at 215-897-8471 or 215-897-7424.

4.3 For aircraft carriers, VTAG and average machine values are available from Supervisor of Shipbuilding Newport News, Aircraft Carrier Planning Office (757-688-5183).

4.4 Equipment Technical Manual will be listed in the invoking Work Item.

4.5 For new or newly overhauled equipment, start of vibration testing can only commence upon satisfactory completion of shipboard operational testing, which will be addressed in the invoking Work Item. Also consider any other adjacent work in the machinery space that may affect accomplishment of vibration testing.

ATTACHMENT A

MACHINERY VIBRATION ANALYSIS REPORT DATA SHEET

DATE: \_\_\_\_\_

SHIP NAME:

HULL:

EQUIPMENT NAME AND POSITION:

Type and method of recording test (X applicable): Velocity (VdB) \_\_\_ / Velocity (in/sec peak) \_\_\_ /  
 Displacement (mils peak to peak) \_\_\_ / Cross-channel \_\_\_ / Absolute \_\_\_

Comments:

Equipment Sketch

<u>POSITIO</u> <u>N</u>	<u>AMP</u>	<u>PHASE</u>	<u>POSITIO</u> <u>N</u>	<u>AMP</u>	<u>PHASE</u>	<u>POSITIO</u> <u>N</u>	<u>AMP</u>	<u>PHASE</u>

EXAMPLE SKETCH AND READINGS FOR  
ATTACHMENT A

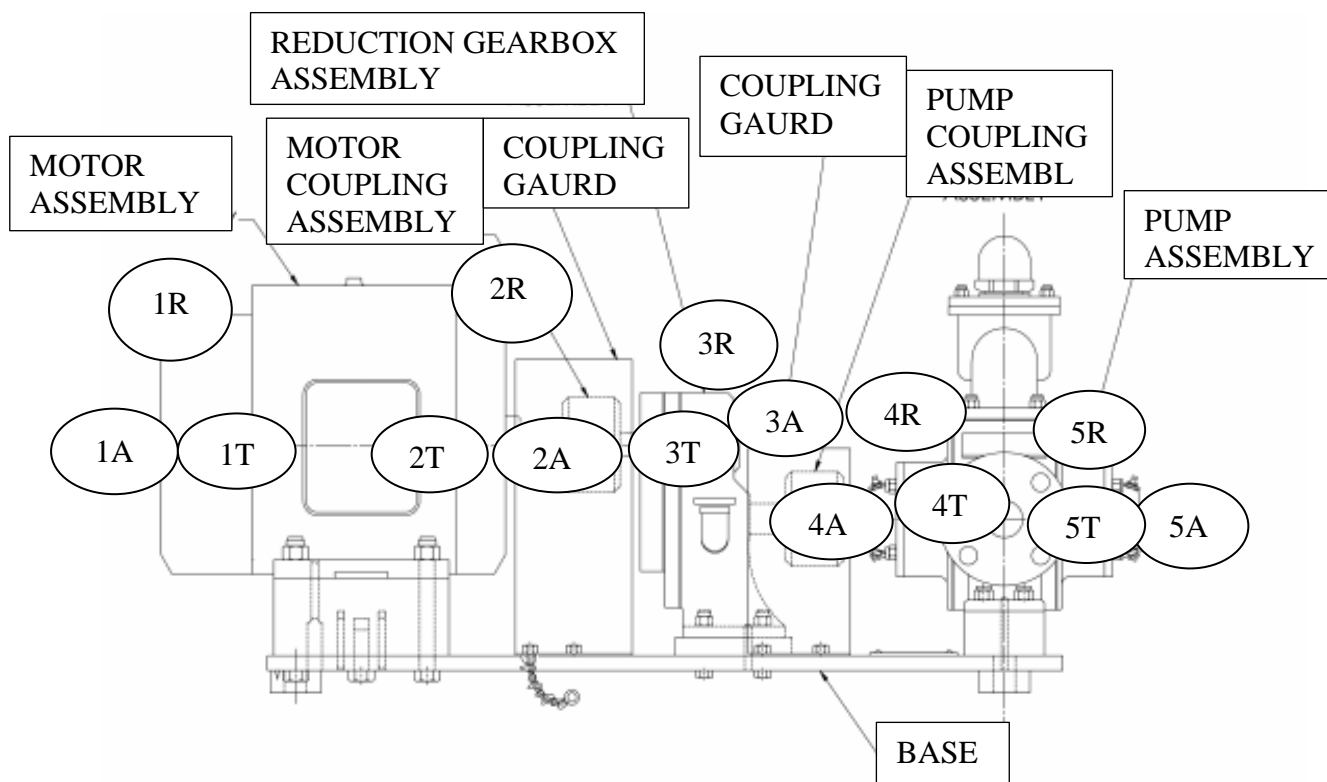

<u>POSITIO</u> <u>N</u>	<u>AMP</u>	<u>PHASE</u>	<u>POSITIO</u> <u>N</u>	<u>AMP</u>	<u>PHASE</u>	<u>POSITI</u> <u>ON</u>	<u>AMP</u>	<u>PHASE</u>
1R	.006	0°	4R	.004	0°			
1A	.030	180°	4A	.006	180°			
1T	.043	90°	4T	.026	90°			
2R	.036	0°	5R	.470	0°			
2A	.020	180°	5A	.003	180°			
2T	.047	90°	5T	.018	90°			
3T	.333	0°						
3R	.014	270°						
3A	.036	45°						

List of Abbreviations: R= Vertical / A= Axial / T= Tangential

ATTACHMENT A  
MACHINERY VIBRATION ANALYSIS REPORT

DATE OF VIBRATION TEST: \_\_\_\_\_

SHIP NAME \_\_\_\_\_ HULL: \_\_\_\_\_

CONTRACT/JOB ORDER NO.: \_\_\_\_\_ WORK ITEM NO.:  
\_\_\_\_\_

IDENTIFY: DRIVER OVERHAULED  YES  NO  
DRIVEN OVERHAULED  YES  NO

EQUIPMENT NAME: \_\_\_\_\_ EQUIP. NO.: \_\_\_\_\_

DRIVER MANUFACTURER: \_\_\_\_\_ SERIAL NO.: \_\_\_\_\_

DRIVEN MANUFACTURER: \_\_\_\_\_ SERIAL NO.: \_\_\_\_\_

VTAG USED: HULL APPLICABILITY: \_\_\_\_\_, SWAB: \_\_\_\_\_, MID: \_\_\_\_\_

RECORD ACTUAL OPERATING CONDITIONS:  
(SPEED, LOAD, PRESSURE, ETC., OR OTHER CONDITIONS AFFECTING THE TEST)

\_\_\_\_\_

\_\_\_\_\_

TEST RPM: \_\_\_\_\_

RECORD VIBRATION TEST EQUIPMENT USED:

COMPONENT	MANUFACTURER	MODEL
ANALYZER		
ACCELEROMETER		
CALIBRATOR		

REPORTING CONTRACTOR: \_\_\_\_\_

PRINTED NAME: \_\_\_\_\_

TESTS RESULTS: SAT  UNSAT  (Provide recommendation for corrective action(s) if UNSAT)

\_\_\_\_\_

\_\_\_\_\_

SIGNATURE: \_\_\_\_\_ PHONE \_\_\_\_\_

SIGNATURE OF PERSON PERFORMING ANALYSIS (INDICATES VIBRATION TESTING IS COMPLETE INCLUDING RECORDING RESULTS/DATA) ATTACH COPY OF VIBRATION SIGNATURES, APPLICABLE VTAG AND AVERAGE MACHINE DATA. FOR NON-VTAG UNITS, PROVIDE BASIC SKETCH.

NAVSEA  
STANDARD ITEM

FY-24

ITEM NO: 009-105  
DATE: 25 OCT 2022  
CATEGORY: II

1. SCOPE:

1.1 Title: Thermal Sprayed Coating for Machinery Component Repair; accomplish

2. REFERENCES:

2.1 Standard Items

2.2 T9074-AA-GIB-010/1687, Thermal Spray Processes for Naval Ship Machinery and Nonskid Applications

2.3 0948-LP-045-7010, Material Control Standard

3. REQUIREMENTS:

3.1 For non-LEVEL I Material Identification and Control (MIC) material repairs, accomplish the requirements of 2.2 for thermal spray coatings on machinery components.

3.2 For LEVEL I MIC material repairs, accomplish the requirements of 2.2 for thermal spray coatings.

3.2.1 Restore LEVEL I markings after coating process in accordance with 2.3.

3.2.2 Accomplishment of Material Identification and Control (MIC) for level I Systems must be in accordance with NAVSEA Standard Items (See Note 4.1).

4. NOTES:

4.1 If Material Identification and Control (MIC) for Level I Systems of 3.2.2 is required; the use of Category II Standard item 009-27 "Material Identification and Control (MIC) for Level I Systems; accomplish" of 2.1 will be specified in the Work Item.

NAVSEA  
STANDARD ITEM

FY-24

ITEM NO: 009-106  
DATE: 25 OCT 2022  
CATEGORY: I

1. SCOPE:

1.1 Title: Work Authorization Form Coordinator (WAFCOR); provide

2. REFERENCES:

2.1 Joint Fleet Maintenance Manual (JFMM)

3. REQUIREMENTS:

3.1 Provide a representative whose function is to coordinate the Work Authorization and Control Process, known as the Work Authorization Form (WAF) Coordinator (WAFCOR), from 30 days prior to the actual scheduled start date of shipboard work, or not later than 5 days after award for Firm Fixed-Price contracts, to the completion of shipboard work.

3.2 The WAFCOR must be responsible for the work authorization control process for all Repair Activity (RA) work being performed during the contract performance period. The WAFCOR must receive, process, compare, and coordinate all WAFs and Technical Work Documents (TWDs) submitted by RAs in accordance with the requirements of Volume IV, Chapter 10, of 2.1. The WAFCOR must meet daily with the designated representatives from each RA, the Commanding Officer's designated representative, and the SUPERVISOR to eliminate any tag-out conflicts, and to advise the SUPERVISOR of any work authorization problems that could impact the RA's or the ship's work operations and testing.

3.2.1 The WAFCOR must ensure that each RA submits a properly filled out WAF. The WAF/TWD must show or explain the job description for each work authorization. The WAFCOR must assign a tracking number and submit the WAF to the Commanding Officer's designated representative. The Commanding Officer's designated representative will determine if adequate isolation and plant/system conditions exist to safely and properly conduct the work, authorize and hang tag-outs, and sign the WAF. Each individual RA must submit work authorizations even if multiple RAs are working on the same components.

3.2.2 The WAFCOR must legibly sign concurrence on the WAF for start of work.

3.2.3 The WAFCOR must ensure that WAF revisions or changes submitted by the cognizant RAs are processed prior to proceeding with the work necessitating the change/revision to the WAF.



4. NOTES:

4.1 Repair Activity (RA) is any activity (public or private) other than Ship's Force involved in the construction, testing, repair, overhaul, refueling, or maintenance of the ship. Repair Activities include the prime contractor, all subcontractors, government provided contractors or agencies, Alteration Installation Teams, Fleet Maintenance Activities, Naval Shipyards, and others.

4.2 Training requirements are listed in NAVSEA Standard Item 009-24.

NAVSEA  
STANDARD ITEM

FY-24

ITEM NO: 009-107  
DATE: 25 OCT 2022  
CATEGORY: II

1. SCOPE:

1.1 Title: Piping System Cleanliness Restoration and Flushing (Non-Nuclear); accomplish

2. REFERENCES:

2.1 Standard Items

2.2 S9AA0-AB-GOS-010, General Specifications for Overhaul of Surface Ships (GSO)

2.3 0902-018-2010, General Specifications for Deep Diving SSBN/SSN Submarines

2.4 S9086-RK-STM-010/CH-505, Piping Systems

2.5 MIL-STD-1330, Precision Cleaning and Testing of Shipboard Oxygen, Helium, Helium-Oxygen, Nitrogen Systems, and Hydrogen Systems

2.6 MIL-STD-419, Cleaning, Protecting, and Testing Piping, Tubing, and Fittings for Hydraulic Power Transmission Equipment

2.7 MIL-STD-1622, Standard Practice for Cleaning of Shipboard Compressed Air Systems

3. REQUIREMENTS:

3.1 Accomplish the general cleaning requirements of 2.2 through 2.4 for new, modified, or repaired non-nuclear piping systems and components of nuclear and non-nuclear powered naval vessels. Accomplish the system cleaning requirements of 2.5 through 2.7.

3.1.1 Where references 2.5 through 2.7 do not contain specific cleanliness exit criteria requirements, clean to the cleanliness levels assigned in section 505j2 of 2.2.

3.2 Accomplishment of a Process Control Procedure (PCP) for the cleaning, flushing, and acceptance criteria of compressed air systems must be in accordance with NAVSEA Standard Items (See Note 4.2) and Section 551 of 2.2 and 2.7.

(I)(G) “VERIFY CLEANLINESS”

3.2.1 Verify cleanliness in accordance with acceptance standards for each leg of the flush when multiple flushing legs are used or a single verification if one complete system flush is used.

(V)(G) “VERIFY PROPER EQUIPMENT AND SETUP”

3.2.2 Verify proper equipment and setup following each configuration change prior to starting flush.

3.3 Accomplishment of a Process Control Procedure (PCP) for the cleaning, flushing, and acceptance criteria of oxygen, nitrogen, and helium systems must be in accordance with NAVSEA Standard Items (See Note 4.2) and Section 552 of 2.2 and 2.5.

(I)(G) “VERIFY CLEANLINESS”

3.3.1 Verify cleanliness in accordance with acceptance standards for each leg of the flush when multiple flushing legs are used or a single verification if one complete system flush is used.

(V)(G) “VERIFY PROPER EQUIPMENT AND SETUP”

3.3.2 Verify proper equipment and setup following each configuration change prior to starting flush.

3.4 Accomplishment of a Process Control Procedure (PCP) for the cleaning, flushing, and acceptance criteria of hydraulic systems must be in accordance with NAVSEA Standard Items (See Note 4.2) and Section 556 of 2.2 and 2.6.

(I)(G) “VERIFY CLEANLINESS”

3.4.1 Verify cleanliness in accordance with acceptance standards for each leg of the flush when multiple flushing legs are used or a single verification if one complete system flush is used.

(V)(G) “VERIFY PROPER EQUIPMENT AND SETUP”

3.4.2 Verify proper equipment and setup following each configuration change prior to starting flush.

3.5 Accomplishment of a Process Control Procedure (PCP) for the cleaning, flushing, and acceptance criteria of fuel oil systems must be in accordance with NAVSEA Standard Items (See Note 4.2) and Section 541 of 2.2.

(I)(G) “VERIFY CLEANLINESS”

3.5.1 Verify cleanliness in accordance with acceptance standards for each leg of the flush when multiple flushing legs are used or a single verification if one complete system flush is used.

(V)(G) “VERIFY PROPER EQUIPMENT AND SETUP”

3.5.2 Verify proper equipment and setup following each configuration change prior to starting flush.

3.6 Accomplishment of a Process Control Procedure (PCP) for the cleaning, flushing, and acceptance criteria of steam systems must be in accordance with NAVSEA Standard Items (See Note 4.2) and Section 253 of 2.2.

(I)(G) “VERIFY CLEANLINESS”

3.6.1 Verify cleanliness in accordance with acceptance standards for each leg of the flush when multiple flushing legs are used or a single verification if one complete system flush is used.

(V)(G) “VERIFY PROPER EQUIPMENT AND SETUP”

3.6.2 Verify proper equipment and setup following each configuration change prior to starting flush.

3.7 Accomplishment of a Process Control Procedure (PCP) for the cleaning, flushing, and acceptance criteria of condensate systems must be in accordance with NAVSEA Standard Items (See Note 4.2) and Section 255 of 2.2.

(I)(G) “VERIFY CLEANLINESS”

3.7.1 Verify cleanliness in accordance with acceptance standards for each leg of the flush when multiple flushing legs are used or a single verification if one complete system flush is used.

(V)(G) “VERIFY PROPER EQUIPMENT AND SETUP”

3.7.2 Verify proper equipment and setup following each configuration change prior to starting flush

3.8 Accomplishment of a Process Control Procedure (PCP) for the cleaning, flushing, and acceptance criteria of lube oil systems must be in accordance with NAVSEA Standard Items (See Note 4.2) and Section 262 of 2.2.

(I)(G) “VERIFY CLEANLINESS”

3.8.1 Verify cleanliness in accordance with acceptance standards for each leg of the flush when multiple flushing legs are used or a single verification if one complete system flush is used.

(V)(G) “VERIFY PROPER EQUIPMENT AND SETUP”

3.8.2 Verify proper equipment and setup following each configuration change prior to starting flush.

3.9 Accomplishment of a Process Control Procedure (PCP) for the cleaning, flushing, and acceptance criteria of each fresh water system must be in accordance with NAVSEA Standard Items (See Note 4.2) and Section 532 of 2.2.

(I)(G) “VERIFY CLEANLINESS”

3.9.1 Verify cleanliness in accordance with acceptance standards for each leg of the flush when multiple flushing legs are used or a single verification if one complete system flush is used.

(V)(G) “VERIFY PROPER EQUIPMENT AND SETUP”

3.9.2 Verify proper equipment and setup following each configuration change prior to starting flush.

3.10 Accomplishment of a Process Control Procedure (PCP) for each cleaning operation of refrigerant systems must be in accordance with NAVSEA Standard Items (See Note 4.2) and section 516 of 2.2.

(I)(G) “VERIFY CLEANLINESS”

3.10.1 Verify cleanliness in accordance with acceptance standards for each leg of the flush when multiple flushing legs are used or a single verification if one complete system flush is used.

(V)(G) “VERIFY PROPER EQUIPMENT AND SETUP”

3.10.2 Verify proper equipment and setup following each configuration change prior to starting flush.

3.11 Accomplishment of a Process Control Procedure (PCP) for the cleaning, flushing, and acceptance criteria of HP/LP steam drains must be in accordance with NAVSEA Standard Items (See Note 4.2) and Section 534 of 2.2.

(I)(G) “VERIFY CLEANLINESS”

3.11.1 Verify cleanliness in accordance with acceptance standards for each leg of the flush when multiple flushing legs are used or a single verification if one complete system flush is used.

(V)(G) “VERIFY PROPER EQUIPMENT AND SETUP”

3.11.2 Verify proper equipment and setup following each configuration change prior to starting flush.

3.12 Accomplishment of a Process Control Procedure (PCP) for the cleaning, flushing, and acceptance criteria of divers air systems must be in accordance with NAVSEA Standard Items (See Note 4.2) and Section 592 of 2.2.

(I)(G) “VERIFY CLEANLINESS”

3.12.1 Verify cleanliness in accordance with acceptance standards for each leg of the flush when multiple flushing legs are used or a single verification if one complete system flush is used.

(V)(G) “VERIFY PROPER EQUIPMENT AND SETUP”

3.12.2 Verify proper equipment and setup following each configuration change prior to starting flush.

3.13 Accomplishment of a Process Control Procedure (PCP) for the cleaning, flushing, and acceptance criteria of gasoline and JP-5 systems must be in accordance with NAVSEA Standard Items (See Note 4.2) and Section 542 of 2.2.

(I)(G) “VERIFY CLEANLINESS”

3.13.1 Verify cleanliness in accordance with acceptance standards for each leg of the flush when multiple flushing legs are used or a single verification if one complete system flush is used.

(V)(G) “VERIFY PROPER EQUIPMENT AND SETUP”

3.13.2 Verify proper equipment and setup following each configuration change prior to starting flush.

3.14 Accomplishment of a Process Control Procedure (PCP) for the cleaning, flushing, and acceptance criteria of distillate piping systems must be in accordance with NAVSEA Standard Items (See Note 4.2) and Section 531 of 2.2.

(I)(G) “VERIFY CLEANLINESS”

3.14.1 Verify cleanliness in accordance with acceptance standards for each leg of the flush when multiple flushing legs are used or a single verification if one complete system flush is used.

(V)(G) “VERIFY PROPER EQUIPMENT AND SETUP”

3.14.2 Verify proper equipment and setup following each configuration change prior to starting flush

4. NOTES:

4.1 This Standard Item does not apply to systems of nuclear-powered ships covered by NAVSEAINST 9210.36, Steam Plant Cleanliness Control, or nuclear piping systems on nuclear-powered ships.

4.2 If a Process Control Procedure (PCP) of 3.2 through 3.14 is required; the use of Category II Standard Item 009-09 “Process Control Procedure (PCP); provide and accomplish” of 2.1 will be specified in the Work Item.

4.3 For boats and craft 65 feet or less in length the requirement for a Process Control Procedure (PCP) for cleaning, flushing and acceptance criteria of the system is not applicable.

NAVSEA  
STANDARD ITEM

FY-24

ITEM NO: 009-109  
DATE: 25 OCT 2022  
CATEGORY: I

1. SCOPE:

1.1 Title: Non-SUBSAFE Work on SUBSAFE-Certified Vessel; accomplish

2. REFERENCES:

2.1 0924-LP-062-0010, Submarine Safety (SUBSAFE) Requirements Manual

2.2 0905-LP-485-6010, Control of Testing and Ship Conditioning

2.3 S9510-AB-ATM-010, Nuclear Powered Submarine Atmosphere Control Manual

2.4 Joint Fleet Maintenance Manual (JFMM)

3. REQUIREMENTS:

3.1 Provide a written training plan for accomplishing non-SUBSAFE work on SUBSAFE-certified vessels, using 2.1 through 2.3 and Volume IV, Chapter 10 of 2.4 for guidance.

3.1.1 Submit one legible copy, in approved transferrable media, of the training plan to the SUPERVISOR no later than 15 days prior to availability start date.

3.1.2 Submit revisions to the training plan to the SUPERVISOR for review and acceptance prior to use.

3.1.3 Implement the approved training plan prior to commencement of non-SUBSAFE work on SUBSAFE-certified vessels.

3.2 Train all personnel (including subcontractors) assigned to perform work on SUBSAFE-certified vessels in accordance with the approved training plan of 3.1 prior to start of work.

3.2.1 All personnel must have direct knowledge of work control procedures, be able to recognize and initiate alarms, be familiar with actions to be taken to evacuate the vessel, and reporting submerged safety draft marks.



3.2.2 Submit one legible copy, in approved transferrable media, of a list of qualified contractor and subcontractor personnel to the SUPERVISOR no later than 15 days prior to start of work. The list must include company name, badge number, and date training was provided, along with certification documentation showing that training requirements have been met.

3.2.2.1 Submit updates to the list as changes occur throughout the availability.

3.3 Accomplish a joint on-site brief and walkthrough of the work site with the SUPERVISOR and the Commanding Officer's designated representative prior to start of work.

3.3.1 Include identification of SUBSAFE components and/or systems located in the area of work, components and/or systems which may be affected by the work, and lessons learned from previous or similar work. Include identification of Unrestricted Operations (URO) Maintenance Requirement (MRC)-related equipment located in the area of work.

3.3.2 Ensure that URO MRC-measured parameter is not violated. (See Volume V, Part-I, Chapter 5 of 2.4.)

3.4 Maintain approved written instructions for accomplishing non-SUBSAFE work on the work site at all times.

3.4.1 Do not accomplish work or disturb any system or component without specific approved written instructions for accomplishing non-SUBSAFE work.

3.5 Prohibit the following items from being brought onboard any nuclear-powered vessel or nuclear support vessel:

3.5.1 Any mercury bearing equipment such as mercury thermometers, portable fluorescent lights, black lights or any other items containing mercury.

3.5.2 Nickel-Cadmium fasteners.

3.5.3 Any device that contains a source of radioactivity.

3.5.4 Bright yellow tools, bags, or equipment.

#### 4. NOTES:

4.1 The SUBSAFE program is a certification program implemented by NAVSEA to ensure strict work controls, material controls, and testing to verify submarine system integrity and prevent loss of submarine personnel and equipment.

4.2 The URO MRC program was developed by NAVSEA to monitor specific areas of interest to determine if the conditions of these areas are suitable for continued unrestricted operations.

4.2.1 URO MRC Manuals:

4.2.1.1 T9081-AD-MMO-010 & 020 (SSN 21 Class)

4.2.1.2 0924-LP-064-8010 (SSN 688 Class)

4.2.1.3 T0700-AA-PRO-010 (SSBN/SSGN 726 Class)

4.2.1.4 T9081-AE-MMO-010 (SSN 774 Class)

NAVSEA  
STANDARD ITEM

FY-24

ITEM NO: 009-110  
DATE: 25 OCT 2022  
CATEGORY: I

1. SCOPE:

1.1 Title: Non-Nuclear Work on a Nuclear Vessel; accomplish

2. REFERENCES:

2.1 Joint Fleet Maintenance Manual (JFMM)

3. REQUIREMENTS:

3.1 Provide a written training plan for accomplishing non-nuclear work on nuclear vessels, using Volume IV, Chapter 10 of 2.1 for guidance.

3.1.1 Submit one legible copy, in approved transferrable media, of the training plan to the SUPERVISOR no later than 15 days prior to availability start date.

3.1.2 Submit revisions to the training plan to the SUPERVISOR for review and acceptance prior to use.

3.1.3 Implement the approved training plan prior to commencement of non-nuclear work on nuclear vessels.

3.2 Train all personnel (including subcontractors) assigned to perform work on a nuclear vessel in accordance with the approved training plan of 3.1 prior to start of work.

3.2.1 All personnel must have direct knowledge of work control procedures, be able to recognize and initiate alarms, and be familiar with actions to be taken to evacuate the vessel.

3.2.2 Submit one legible copy, in approved transferrable media, of a list of qualified contractor and subcontractor personnel to the SUPERVISOR no later than 15 days prior to start of work. The list must include company name, badge number, and date training was provided, along with certification documentation showing that training requirements have been met.

3.2.2.1 Submit updates to the list as changes occur throughout the availability.

3.3 Accomplish a joint on-site brief and walkthrough of the work site with the SUPERVISOR and the Commanding Officer's designated representative prior to start of work.

3.3.1 Include identification of all nuclear equipment including nuclear temporary/support systems and radiological containment materials located in the area of work, components and/or systems which may be affected by the work, and lessons learned from previously accomplished or similar work.

3.3.2 Evaluate services/temporary systems to be installed by the contractor that run through spaces containing nuclear equipment for possible leakage/spray protection.

3.3.3 The contractor must identify all possible contact with nuclear equipment or nuclear temporary/support system identified in the space prior to start of work.

3.3.4 Evaluate the rigging path for potential collateral damage to nuclear components/piping. All inadvertent contact with nuclear equipment or nuclear temporary/support system in the work area during the work must be brought immediately to the attention of the SUPERVISOR.

3.3.5 Submit one legible copy, in approved transferrable media, of a written report of the requirements of 3.3 to the SUPERVISOR within one day after completion of the briefing and walkthrough.

3.4 Maintain approved written instructions for accomplishing non-nuclear work on the work site at all times.

3.4.1 Do not accomplish work or disturb any system or component without specific approved written instructions for accomplishing work on nuclear vessels.

3.5 Material (permanent or temporary) must not contact nuclear piping/components unless specifically authorized by the SUPERVISOR. Some examples are cleaning fluid sprays, dripping grease or liquids, inadvertent paint splatter, attaching rope or strings, wood, tape, plastic bags, temporary contractor's services that contact hot or cold nuclear piping and components.

3.6 Report immediately inadvertent contact with or damage to nuclear equipment regardless of how minor (e.g., gouges, scratches, dents, slag, carbon arc, corrosion) to the SUPERVISOR.

3.7 Prohibit the following items from being brought onboard any nuclear-powered vessel or nuclear support vessel:

3.7.1 Any mercury bearing equipment such as mercury thermometers, portable fluorescent lights, black lights or any other items containing mercury.

3.7.2 Nickel-Cadmium fasteners.

3.7.3 Any device that contains a source of radioactivity.

3.7.4 Bright yellow tools, bags, or equipment.

4. NOTES:

4.1 None.

NAVSEA  
STANDARD ITEM

FY-24

ITEM NO: 009-111  
DATE: 25 OCT 2022  
CATEGORY: I

1. SCOPE:

1.1 Title: Schedule and Associated Reports for non-CNO Availabilities; provide and manage

2. REFERENCES:

2.1 Standard Items

2.2 S9AA0-AB-GOS-010, General Specifications for Overhaul of Surface Ships (GSO)

3. REQUIREMENTS:

3.1 Develop an initial Integrated Production Schedule (IPS) for work packages in duration that reflects the manner in which the availability will be accomplished. The IPS must:

3.1.1 Schedule each Work Item to the Work Activity level listing the start and completion dates, and durations for each Work Activity.

3.1.1.1 Assign each Work Activity in the IPS a short title to describe the nature of the Work Activity, system and equipment or machinery involved.

3.1.1.2 Integrate all provided Alteration Installation Team (AIT), Government-Contracted Third Party Maintenance Provider, Ship's Force, Commercial Industrial Services (CIS), and Fleet Maintenance Activity (FMA) work. The SUPERVISOR will provide, or direct provision, of the AIT, Government-Contracted Third Party Maintenance Providers, Ship's Force, CIS, and FMA availability data required for schedule integration.

3.1.2 Scheduled Key Events and Milestones.

3.1.2.1 Assign appropriate predecessor relationships to each work activity, Key Event, and Milestone(s) to ensure there is an accurate logical progression through all Work Activities leading to their assigned Key Event and Milestone(s), to ensure the IPS supports accurate prediction of Key Event and Milestone(s) attainment.

3.1.3 Critical Path and Controlling Work Items.

3.1.4 Scheduled start and completion dates of all Stage 3 through Stage 6 required tests. Test Stages are defined in Section 092 of 2.2.

3.1.5 Descope activities must remain in the schedule until settlement of the associated change. Corresponding hours and schedule logic may be removed and/or updated accordingly.

3.1.6 In execution of the availability, the contractor may allow dates to exceed the contract period of performance. This does not constitute government approval of a change to the end of availability.

3.2 Revise Production Schedule/IPS at the Work Activity level weekly to include info provided in 3.1.1.2 for AIT work, additions, deletions, modifications, actual start and finish dates, progress, and completion of Work Items. Progress must be based on degree of completion of physical work or accomplishment of the Work Activity.

3.3 Provide contractor representation to participate in the weekly progress meeting at the time and location agreed to by the SUPERVISOR. The representative(s) must be authorized to make management decisions relative to the routine requirements of the Job Order that, in good faith, commit the contractor. AIT Managers and/or On-Site Installation Coordinators (OSIC) must participate and represent respective alteration teams in scheduled weekly progress meetings.

3.3.1 Weekly progress meeting participants must be prepared to address Critical Path and Controlling Work Items, and offer reasonable solutions to problems which may have impact on scheduled Key Events and Milestones or completion date. Contractors scheduled work, AIT work and Ship's Force work must be discussed to support and de-conflict any testing and equipment operation scheduled.

3.4 Develop one legible copy, in approved transferrable media, of an availability status report that includes the revised IPS in accordance with Table 1. Note: some requirements may be submitted as separate attachments as specified within the table.

Table 1  
Activity Data Elements and Descriptions.

Data Element	Description	All Non-Combatant Craft and Combatant Craft Availabilities less than 36 days	Combatant Craft Availabilities 36 days or greater
Work Item Number (as appropriate)	4-E specification Work Item number	X	X
Title	Descriptive title of Work Item and Work Activity	X	X

Key Event	Key Event applicable to the Work Activity (See 4.1.6)		X
Milestone (as appropriate)	Milestone applicable to the Work Activity (See 4.1.7)		X
System (as appropriate)	System(s) affected		X
Component (as appropriate)	Component Unit (For example: tank, valve, motor, pump)		X
Location	Work location/compartament number		X
Executing Activity	ID specific organization: Prime KTR, Sub-KTR, FMA, SMMO, AIT, or OSIC	X	X
Early Start	Software determined date (See 4.1.15)	X	X
Early Finish	Software determined date (See 4.1.16)	X	X
Actual Start	Actual date for the Work Activity's start	X	X
Actual Finish	Actual date for the Work Activity's finish	X	X
Percent Complete (Actual)	Degree of completion based on the Work Activity's work scope and degree of accomplishment of production labor.	X	X
Duration	The total number of work periods required to complete a Work Activity.	X	X
Calendar Identification	Number of scheduled workdays per week	X	X
Total Float	The total number of workdays that the Contractor can delay a Work Activity without affecting the project finish date.	X	X
Predecessor	An Activity or Event that immediately precedes one or more Activities or Events with a direct tie in the Total Project Network. Every Activity and Event in the Total Project Network must have at least one Predecessor (except Start Availability).	X	X
Successor	An Activity or Event that immediately follows one or more Activities or Events with a direct tie in the Total Project Network. Every Activity and Event in the Total Project Network must have at least one Successor (except Complete Availability).	X	X



Constraints	Constraints used as applicable to Work Item or Work Activity. This may be provided within the predecessor or successor field.		X
Incomplete GFI Report	Provide an updated list of all GFI not received by the contractor. This submittal does not have to be in the IPS but can be a stand-alone document.	X	X
Planned Progress Percent	The contractor is to provide an overall availability planned progress percent. This submittal does not have to be in the IPS but can be a stand-alone document.	X	X
Actual Progress Percent	The contractor is to provide an overall availability actual progress percent. This submittal does not have to be in the IPS but can be a stand-alone document.	X	X

3.5 If requested by the SUPERVISOR, provide contractor representation to participate in a review conference to be held at the 50-percent progress in the availability.

3.5.1 Data from the most recent submission in accordance with 3.2 and 3.4 will be used at the review conference. Review conferences will be held simultaneously with the Weekly Progress Meeting. The conferences will be scheduled at a time and place mutually agreeable to all parties.

3.6 Submit the following reports to the SUPERVISOR as listed in Table 2 in the specified format and timeline.

Table 2 Schedule Submission Requirements:

ID Number	Requirements	Title	Format	Due
3.6.1	3.1 Per Table 1	- Initial IPS - Incomplete GFI Report	.xls or .pdf or native format	The earlier of Avail Start -5 or after contract award +5
3.6.2	3.4	- Availability Status Report	.xls or .pdf or native format	Weekly after A-0, one day prior to progress meeting

4. NOTES:

## 4.1 Definitions.

4.1.1 Critical Path Method: The critical path method is used to derive the critical activities—that is, activities that cannot be delayed without delaying the end date of the program. The amount of time an activity can slip before the program’s end date is affected is known as “total float.” Additionally, the critical path method for planning and executing complex, interdependent projects that identifies the Critical Path to each Key Event and Milestone using automated Network Analysis Tools. Unless the IPS represents the entire scope of effort and the effort is correctly sequenced through network logic, the scheduling software will report an incorrect or invalid critical path. That is, the critical path will not represent the activities affecting the program finish date. With no accurate critical path, management cannot focus on the activities that will be detrimental to the program’s key milestones and finish date if they slip.

4.1.2 Stage Testing: Conducted by using stages of testing for the progressive validation of the proper installation and performance of equipment and systems. Test Stages are identified in 009-67 of 2.1.

4.1.3 Integrated Production Schedule (IPS): A schedule used by the contractor as a means of planning, tracking, coordinating and de-conflicting work during the availability. It incorporates all work planned for accomplishment during the maintenance availability including; Alteration Installation Team (AIT), Government-Contracted Third Party Maintenance Providers, Ship’s Force, Commercial Industrial Services (CIS), and Fleet Maintenance Activity (FMA) work. An IPS connects all the scheduled work of the government and the contractor in a network, or collection of logically linked sequences of activities. The sequences clearly show how related portions of work depend on one another, including the relationships between the government and contractors.

4.1.4 Work Activity: A portion of an individual Work Item, which is a logical subdivision of the Work Item, representing a manageable unit of work which must be accomplished at a specific period of time in relation to other Activities of the Job Order.

4.1.5 Duration: The total number of work periods (not including holidays or other nonworking periods) required to complete a scheduled Work Activity.

4.1.6 Key Event: An event that, if slippage occurs, could impact or delay the overall schedule, or prevent timely delivery of the vessel.

4.1.7 Milestone: Milestones are used as a scheduling aid and establish significant points where progress must be evaluated and confirmed. Accumulated failure to achieve Milestones on schedule may result in missed Key Events.

4.1.8 Critical Path: That sequence of Work Activities which forms the work and test chain of the longest duration, and directly affects the completion of the availability. Factors that influence when a Work Activity is on the Critical Path include: time duration required for

the Work Activity, space limitations, manpower available, and the predecessor/successor relationships between Work Activities. The Critical Path is determined by automated schedule analysis and will include any sequential set of Work Activities forming the longest chain of events extending throughout the schedule and which has the least Total Float.

4.1.9 Controlling Work Items: Those Work Items which include activities that are on the critical path of the IPS, which, by virtue of scope, material requirements, complexity, or other considerations, have the significant potential for impact on the scheduled project Key Events or completion of the availability.

4.1.10 Total Float: The total number of days that the Contractor can delay a Work Activity without affecting the project finish date. A path of Work Activities is established by predecessor and successor relationships.

4.1.11 Logic Relationship: Defines an interdependence between Work Activities. It is established by assigning predecessor and successor relationships to Work Activities using the functionality provided by project scheduling software. An individual Work Activity will frequently have more than one predecessor or more than one successor.

4.1.12 Baseline Start or Baseline Finish. The date identified in the IPS when the contractor plans to start or finish (respectively) the Work Activity. This may be established by a controlled schedule baseline (preferred method) or by manual entry into the scheduling software according to contractor policy/practice.

4.1.13 Planned progress percent. Baseline progress of work to be completed based on planned start and planned finish dates.

4.1.14 Actual Progress percent. Degree of overall availability completion based on the work scope and degree of accomplishment of production labor.

4.1.15 Early Start: The earliest point in time that a Work Activity may start based on the IPS network logic and any other schedule constraints. Early start dates may change as the availability progresses.

4.1.16 Early Finish: The earliest point in time that a Work Activity may be completed based on the IPS network logic and any schedule constraints. Early finish dates may change as the availability progresses

4.1.17 Integration: The incorporation of all work (including testing and availability work certification) for all organizations involved in an availability.

4.1.18 Negative Float: The amount of time by which the early start or finish dates of a Work Activity exceeds its late start or ending dates. The quantity of float then indicates the amount of time that must be recovered in order to achieve an imposed date.

4.1.19 Hard Constraint: A Mandatory Start or Finish date imposed on an activity, i.e. the activity becomes fixed to that date. Typically expressed as the activity Must Start On (MSO) or Must Finish On (MFO) the given date. Hard Constraints prevent their associated activity from being logic-driven.

4.1.20 Lags and Leads. Lags and Leads are scheduling functions used to represent a gap (Lag) or overlap (Lead) between activities. The use of Lags and Leads must be controlled to ensure they support an accurate and logical work flow. Improper and overuse of Lags and Leads can have a detrimental effect on a logic driven schedule and adversely affect float and the Critical Path. Typical examples where their use may be warranted include: insertion of time delay to represent report cycle time, staggering unrelated work item start dates, or drive work based on material receipt projection.

4.1.20.1 Lag: The delayed start of a successor activity and represents time that must pass before the second activity can begin.

4.1.20.2 Lead: The accelerated start of a successor activity where there is a finish to start relationship. The second activity can begin and be conducted in parallel with the first activity.

Table 1

## Activity Data Elements and Descriptions.

Data Element	Description	All Non-Combatant Craft and Combatant Craft Availabilities less than 36 days	Combatant Craft Availabilities 36 days or greater
Work Item Number (as appropriate)	4-E specification Work Item number	X	X
Title	Descriptive title of Work Item and Work Activity	X	X
Key Event	Key Event applicable to the Work Activity (See 4.1.6)		X
Milestone (as appropriate)	Milestone applicable to the Work Activity (See 4.1.7)		X
System (as appropriate)	System(s) affected		X
Component (as appropriate)	Component Unit (For example: tank, valve, motor, pump)		X
Location	Work location/compartment number		X
Executing Activity	ID specific organization: Prime KTR, Sub-KTR, FMA, SMMO, AIT, or OSIC	X	X
Early Start	Software determined date (See 4.1.15)	X	X
Early Finish	Software determined date (See 4.1.16)	X	X
Actual Start	Actual date for the Work Activity's start	X	X
Actual Finish	Actual date for the Work Activity's finish	X	X
Percent Complete (Actual)	Degree of completion based on the Work Activity's work scope and degree of accomplishment of production labor.	X	X

Duration	The total number of work periods required to complete a Work Activity.	X	X
Calendar Identification	Number of scheduled workdays per week	X	X
Total Float	The total number of workdays that the Contractor can delay a Work Activity without affecting the project finish date.	X	X
Predecessor	An Activity or Event that immediately precedes one or more Activities or Events with a direct tie in the Total Project Network. Every Activity and Event in the Total Project Network must have at least one Predecessor (except Start Availability).	X	X
Successor	An Activity or Event that immediately follows one or more Activities or Events with a direct tie in the Total Project Network. Every Activity and Event in the Total Project Network must have at least one Successor (except Complete Availability).	X	X
Constraints	Constraints used as applicable to Work Item or Work Activity. This may be provided within the predecessor or successor field.		X
Incomplete GFI Report	Provide an updated list of all GFI not received by the contractor. This submittal does not have to be in the IPS but can be a stand-alone document.	X	X
Planned Progress Percent	The contractor is to provide an overall availability planned progress percent. This submittal does not have to be in the IPS but can be a stand-alone document.	X	X

Actual Progress Percent	The contractor is to provide an overall availability actual progress percent. This submittal does not have to be in the IPS but can be a stand-alone document.	X	X
-------------------------	--	---	---

STANDARD ITEM

FY-24

ITEM NO: 009-112  
DATE: 25 OCT 2022  
CATEGORY: II

1. SCOPE:

1.1 Title: Prevention of Radiographic-Inspection Ionizing-Radiation Hazard; accomplish

2. REFERENCES:

- 2.1 NAVMED P-5055, Radiation Health Protection Manual
- 2.2 10 CFR Part 20, Standards for Protection Against Radiation
- 2.3 10 CFR Part 34, Licenses for Industrial Radiography and Radiation Safety Requirements for Industrial Radiographic Operations

3. REQUIREMENTS:

3.1 This item applies to all contracts that utilize radiographic inspection as part of their work. "Foreign contractor" refers to a contractor that is contracted from the U.S. Navy host country in which U.S. Navy contracts may be executed onboard U.S. Government property and/or vessels.

3.2 Each foreign contractor must comply with the regulatory standards of the host country when conducting radiographic inspections on U.S. Government property and/or vessels.

3.3 Submit one legible copy, in hard copy or approved transferrable media, of completed Radiography Operations Planning Work Sheet, Attachment A, to the SUPERVISOR fourteen days prior to start of work (unless otherwise approved by the SUPERVISOR) and obtain approval prior to commencement of radiography operations.

3.4 Submit one legible copy, in hard copy or approved transferrable media, of a diagram illustrating the boundary where the exposure rate must not exceed 2 mr/hr (0.02 mSv/hr) or under special circumstances the dose to an individual in any unrestricted area would not exceed 2 mrem (0.02mSv) in any one hour, to the SUPERVISOR no later than 14 days prior to start of work. In addition, the boundary must meet the requirement that no individual member of the public will receive a dose in excess of 100 mrem (1mSv) in a calendar year from the radiographic work, exclusive of background radiation in accordance with 2.1 and 2.2.



3.4.1 In addition to the boundary requirements of 3.4, the foreign contractor must also illustrate the foreign radiation-boundary requirements.

3.5 Establish a physical boundary where the exposure rate is 2mr/hr or less. In some circumstances the boundary may be established at a point where the dose to an individual in any unrestricted area would not exceed 2 mrem in any one hour. The perimeter of the radiation area must be a physical barrier established by an enclosure or by stanchions and rope, as necessary. Post this boundary with tri-foil radiation warning symbol, "Radiation Area", "Radiography in Progress", and "Keep Out" signs written in English and host-country language. The signs must be visible to any person approaching the radiation area barrier from any accessible direction.

3.5.1 Radiographer must maintain constant surveillance of the entire area boundary through direct observation or Radiation Safety Officer (RSO)/Radiation Safety Oversight Manager (RSOM) approved positive communication with boundary monitor who is in a position to provide visual surveillance in accordance with 2.3.

3.5.2 Monitor the entire boundary using radiation detection equipment appropriate for the source of radiation during the first radiation exposure of the day. If the beam's orientation, kVp, mA, collimation, or shielding is changed between exposures, the boundary must be re-surveyed and re-established in accordance with 3.5, if necessary.

3.5.2.1 Submit one legible copy, in hard copy or approved transferrable media, of a report listing results of the requirements of 3.5.2 to the SUPERVISOR, within one day. The report must include Attachment A diagram identifying survey locations, time, date and location of the survey, the highest radiation level recorded, the kVp, mA, and beam direction of the x-ray machine or, if using gamma source material, the half value of the collimator and beam direction at the time of exposure.

3.6 If an unauthorized individual crosses the boundary, the boundary monitor must immediately notify the radiographer who will immediately stop radiography operations.

3.6.1 Report any boundary violation immediately to the SUPERVISOR, using the most expeditious form of communication. Submit one legible copy, in hard copy or approved transferrable media, of a follow-up report, to the SUPERVISOR, within 4 hours of the violation, using Boundary Violation Report, Attachment B.

3.7 Upon discovery of loss or theft of radioactive material or x-ray producing devices or any deviation from the Operations Planning Worksheet (Attachment A), the radiographer must cease and make safe all radiographic operations and immediately notify the SUPERVISOR.

3.7.1 Report verbally each incident immediately to the SUPERVISOR.

3.7.1.1 Submit one legible copy, in approved transferrable media, of a formal written report of the incident within one day to the SUPERVISOR.

#### 4. NOTES:

4.1 The SUPERVISOR must perform oversight and surveillance of all radiography operations on U.S. Government property and/or vessels associated with contracted work.

4.2 The technical point of contact for the requirements contained in this Standard Item is SUPERVISOR's RSO or RSOM for radiographic inspections conducted in the host-country and any U.S. Government Detachment.

4.3 This Standard Item complies with 10 CFR Parts 19, 20, and 34 and 29 CFR 1910.1096.

ATTACHMENT A  
RADIOGRAPHY OPERATIONS PLANNING WORK SHEET

A. General Information

1. Prime Contractor Name: \_\_\_\_\_

2. Subcontractor Name (if applicable): \_\_\_\_\_

3. Proposed Date(s) and Time(s) of Planned Radiography: \_\_\_\_\_

4. Purpose of Radiographic Operation: \_\_\_\_\_

5. Host country regulatory standards applicable to radiographic inspections preferably translated to English.

B. If conducting gamma radiography complete the following:

1. Radioisotope: \_\_\_\_\_ Serial Number: \_\_\_\_\_

2. Activity: \_\_\_\_\_ Date of Determination of Activity: \_\_\_\_\_

3. Collimator Serial Number (If Applicable) : \_\_\_\_\_

4. Half Value Layers / Thickness:

5. Total number of Exposures (estimated): \_\_\_\_\_

6. Direction of the Beam: \_\_\_\_\_

7. Transportation and vehicle information:

a. Manufacturer: \_\_\_\_\_

b. Model:

c. License Plate Number: \_\_\_\_\_

d. Sign on Vehicle: \_\_\_\_\_

e. Driver's Name: \_\_\_\_\_

f. Passengers: \_\_\_\_\_

g. Location of radiography operation site (ship, submarine, building, pier):  
\_\_\_\_\_

h. Transportation route to be taken to and from work site while on Government activity:

\_\_\_\_\_

C. If conducting x-ray radiography complete the following:

1. Machine Manufacturer: \_\_\_\_\_
2. Serial Number: \_\_\_\_\_
3. Maximum kVp: \_\_\_\_\_
4. Maximum mA: \_\_\_\_\_
5. Total Number of Exposures (estimated): \_\_\_\_\_
6. Direction of Beam: \_\_\_\_\_

D. Provide a diagram of each work site that illustrates:

1. Each location of the radiography, including major features such as walls, bulkheads, tanks, walkways or passageways that may provide shielding or difficulty in controlling the area.
2. The location of the exposure device drive cable, guide tube, and end stop if using gamma radiography equipment, or the location of the tube head and control panel if conducting x-ray radiography.
3. The location of the 2 mr/hr (0.02 mSv/hr) controlled boundary.

E. Provide the calculations for the 2 mr/hr (0.02 mSv/hr) controlled boundary from the distance from the gamma radiography source, or the x-ray machine tube head, to the location where the boundary must be established.

F. Review/Approval:

Contractor's Radiographer: \_\_\_\_\_  
Name (Printed)  
\_\_\_\_\_  
Signature  
Date: \_\_\_\_\_

RSO/RSOM (SUPERVISOR's) Approval: \_\_\_\_\_  
Name (Printed)  
\_\_\_\_\_  
Signature  
Date: \_\_\_\_\_

**ATTACHMENT B  
FOR OFFICIAL USE ONLY**

<b>BOUNDARY VIOLATION REPORT</b>
Report #

<u>NAME OF REPORTING INDIVIDUAL:</u>	
<u>TIME/DATE OF THE VIOLATION:</u> <u>LOCATION OF THE VIOLATION:</u>	<u>COMPANY:</u> <u>SUPERVISOR:</u>
<u>EQUIPMENT INVOLVED</u>	
<u>FOR GAMMA RADIOGRAPHY:</u>  <u>ISOTOPE:</u> <u>ACTIVITY:</u> <u>HALF VALUE OF THE COLLIMATOR:</u> <u>DURATION OF EXPOSURE:</u>	<u>FOR X-RAY RADIOGRAPHY</u>  <u>mA:</u> <u>kVp:</u> <u>DURATION OF EXPOSURE:</u>
<u>WORK ITEM NUMBER:</u>	<u>CONTRACT NUMBER:</u>

**INDIVIDUALS WHO VIOLATED THE BOUNDARY**

NAME(S)	DEPT.	ORGANIZATION/COMPANY

**NAMES OF THE RADIOGRAPHY CREW MEMBERS,  
INCLUDING NAMES OF BOUNDARY MONITORS**

NAME(S)	DEPT.	COMPANY

ATTACHMENT B  
FOR OFFICIAL USE ONLY

DESCRIPTION OF BOUNDARY VIOLATION

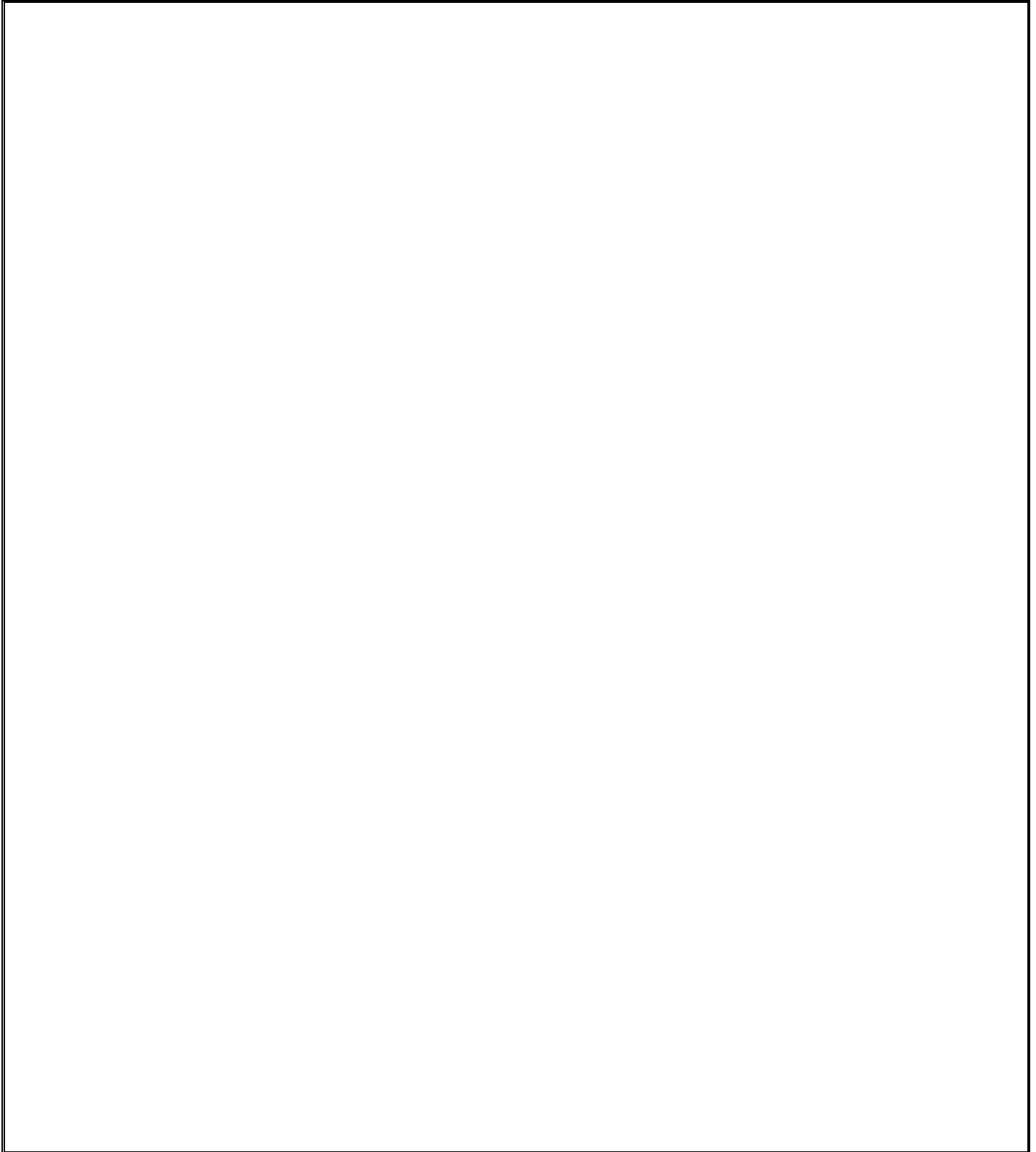

DIAGRAM SHOWING THE LOCATION OF THE VIOLATION AND THE EGRESS PATH IN RELATION  
TO THE SOURCE

ATTACHMENT B  
FOR OFFICIAL USE ONLY

<u>SIGNATURE OF REPORTING INDIVIDUAL:</u>	DATE:
---	-------

Incident Report Instructions

REPORT NUMBER- Unique tracking number created by contractor  
8 of 9

ITEM NO: 009-112  
FY-24

ATTACHMENT B  
FOR OFFICIAL USE ONLY

NAME OF REPORTING INDIVIDUAL: – Self Explanatory

DATE/TIME OF THE VIOLATION: – Self Explanatory

LOCATION OF THE VIOLATION: – Base/Yard, Ship name and hull number, space number and compartment name

COMPANY: – Prime and subcontractors involved

SUPERVISOR – Supervisor of employee(s) involved

EQUIPMENT INVOLVED – Self Explanatory

WORK ITEM NUMBER – Work Item being accomplished when incident occurred

CONTRACT NUMBER: – Contract Number assigned by government agency i.e. RMC, AIT Sponsor.

INDIVIDUALS WHO VIOLATED THE BOUNDARY: – Name, Department and Organization/Company of individuals that violated the boundary.

NAMES OF THE RADIOGRAPHY CREW MEMBERS, INCLUDING NAMES OF BOUNDARY MONITORS: – Name, Department and Company of the members of the radiography crew, including names of boundary monitors.

DESCRIPTION OF BOUNDARY VIOLATION: – Narrative description of the boundary violation including the sequence of events, time line, estimated exposures to individuals who violated the boundary, the immediate corrective actions taken to secure operations and emergency notifications that were made.

DIAGRAM SHOWING THE LOCATION OF THE VIOLATION AND THE EGRESS PATH IN RELATION TO THE SOURCE: – A diagram of the location of the boundary violation showing the egress path and location of the individual(s) that violated the boundary, location of the source, beam direction (for x-ray machine radiography or gamma radiography if collimator was used) and the location of any barriers, walls, or equipment that would provide shielding.

SIGNATURE OF REPORTING INDIVIDUAL: – Self Explanatory.

TITLE – Self Explanatory.

DATE – Self Explanatory.



NAVSEA  
STANDARD ITEM

FY-24

ITEM NO: 009-113  
DATE: 25 OCT 2022  
CATEGORY: II

1. SCOPE:

1.1 Title: Rotating Electrical Equipment with a Sealed Insulation System (SIS); rewind

2. REFERENCES:

2.1 Standard Items

2.2 MIL-STD-2037, Procedure to Obtain Certification for Electric Motor Sealed Insulation Systems

2.3 Equipment Technical Manual

2.4 S9086-DA-STM-010-/CH-100, Hull Structures

2.5 S9086-KC-STM-010/CH-300, Electric Plant - General

2.6 S9086-KE-STM-010/CH-302, Electric Motors and Controllers

2.7 S9086-KN-STM-010/CH-310, Electric Power Generators and Conversion Equipment

2.8 S9086-HN-STM-010/CH-244, Propulsion Bearings and Seals

2.9 S6260-BJ-GTP-010, Electrical Machinery Repair, Electric Motor, Shop Procedures Manual

2.10 MIL-DTL-17060, Motors, Alternating Current, Integral-Horsepower, Shipboard Use

2.11 MIL-STD-1310, Shipboard Bonding, Grounding, and Other Techniques for Electromagnetic Compatibility, Electromagnetic Pulse (EMP) Mitigation, and Safety

2.12 T9070-A2-DPC-010/302-1, AC MOTOR AND CONTROLLER APPLICATION REQUIREMENTS

3. REQUIREMENTS:

3.1 Ensure only Repair Activities certified by Naval Sea Systems Command (NAVSEA) in accordance with 2.2 rewind motors with a Sealed Insulation System (SIS). (See Note 4.1)

3.1.1 Submit one legible copy, in hard copy or approved transferrable media, of the NAVSEA Certification Recertification letter confirming the Repair Activity has fulfilled the requirements for the SIS process to the SUPERVISOR. The NAVSEA letter must indicate the type of motors and the range of motor frame sizes the activity is qualified to rewind.

3.1.2 Submit any change of certification as it occurs to the SUPERVISOR.

3.2 Disconnect equipment mechanically and remove, including rotating components connected directly to the shaft, using 2.3 for guidance.

3.2.1 Accomplish the following prior to disconnecting; measure air gap readings; measure bearing clearances for sleeve bearing equipment only; inspect couplings for cracks, broken segments, wear, and misalignment in excess of tolerances specified in 2.3; measure shaft thrust and run out readings; identify associated cables/wiring and hook-up data. Record data in Attachment B-2 or equivalent form that contains the requirements of Attachment B-2.

3.2.2 Matchmark, identify, and retain chocks, shims, shock mounts, sound damping pads, and other accessories associated with equipment. Record list of accessories in Attachment B-2 or equivalent form that contains the requirements of Attachment B-2.

3.3 Remove equipment including rotating components connected directly to the shaft.

3.3.1 Remove entire vaneaxial and tubeaxial fan assemblies from the duct system and transport to the shop for repair.

3.4 Accomplish a structural inspection of each foundation in accordance with 2.4. Record data in Attachment B-2 or equivalent form that contains the requirements of Attachment B-2.

3.4.1 Accomplishment of cleaning and painting requirements for foundations of equipment must be in accordance with NAVSEA Standard Items. (See Note 4.8)

3.5 Matchmark, disassemble, test, inspect, measure, rewind, insulate, and bake the equipment in accordance with the Repair Activity SIS Rewind Procedure (SISRP), using 2.3 and 2.5 through 2.9 for guidance, and the following:

3.5.1 Accomplish a core loss test prior to winding removal. Record data in Attachment B-1 or equivalent form that contains the requirements of Attachment B-1.

3.5.1.1 Accomplish a loop test in accordance with Paragraphs 5.1.2.3.3(a) (1) through (16) or 5.1.2.3.3(b) (1) through (12) as applicable of 2.2 when core indicates a marginal satisfactory reading or when test equipment does not directly support

equipment being subjected to testing. Record data in Attachment B-1 or equivalent form that contains the requirements of Attachment B-1.

3.5.1.2 Inspect for hot spots in accordance with the Core Loss Tester Instruction Manual. Record data in Attachment B-1 or equivalent form that contains the requirements of Attachment B-1.

3.5.2 Remove each winding. Accomplish core inspection in accordance with 2.9. Record data in Attachment B-1 or equivalent form that contains the requirements of Attachment B-1.

3.5.2.1 Verify the temperature limitations of the core material prior to exercising the burnout oven option. The surface temperature of the laminated iron surface must be determined by thermocouple and must not exceed 370 degrees Centigrade (698 degrees Fahrenheit). Record data in Attachment B-1 or equivalent form that contains the requirements of Attachment B-1.

3.5.2.2 Record winding data. Verify conformance of recorded data to the manufacturer's winding data. Record data in Attachment B-1 or equivalent form that contains the requirements of Attachment B-1.

3.5.2.3 Repeat core loss test, loop test, and inspection for hot spots, described in 3.5.1 through 3.5.1.2, after winding removal. Record data in Attachment B-1 or equivalent form that contains the requirements of Attachment B-1.

3.5.3 Dip core for preservation.

3.5.4 Protect machined surfaces. Accomplishment of cleaning and painting for equipment housing exterior, fan(s), interior and exterior of each end bell must be in accordance with NAVSEA Standard Items (See Note 4.8).

3.5.5 Inspect each rotor for cracked bars, localized overheating, rubbing, insulation damage, and burns/hot spots. Record data in Attachment B-1 or equivalent form that contains the requirements of Attachment B-1.

3.5.6 Inspect and dimensionally measure end bells, frame, rabbet fits, shaft, sleeve and pedestal bearings, keyways, fan and running surfaces for wear, eccentricity, and other defects, using 2.3 for accept or reject criteria, and 2.8 for location and type of measurements to be taken. Record data in Attachment C or equivalent form that contains the requirements of Attachment C.

3.5.7 Rewind the equipment, using the Original Equipment Manufacturers (OEM) "for Navy use" winding data. Connect windings permanently only after successful completion of testing of 3.5.8 through 3.5.11. Install new material conforming to: SISRP; Temperature detectors conforming to 2.3. Record data in Attachment B-1 or equivalent form that contains the requirements of Attachment B-1.

3.5.8 Accomplish 500-volt megger insulation resistance test, using Paragraphs 300-3.2.2 through 300-3.2.3, 300-3.4.8, 300-3.4.11, and 300-5.3.7.1 of 2.5 for guidance. Record data. Record data in Attachment B-1 or equivalent form that contains the requirements of Attachment B-1.

3.5.9 Accomplish a phase resistance balance test of windings, using a Wheatstone or Kelvin bridge, or with an ohmmeter capable of resolving one milliohm (0.001 ohm), using 3.6.1 of 2.10 for guidance. Record phase balance for multi-phase equipment. Record data in Attachment B-1 or equivalent form that contains the requirements of Attachment B-1.

3.5.10 Accomplish a voltage surge test. Record data in Attachment B-1 or equivalent form that contains the requirements of Attachment B-1.

3.5.11 Accomplish a DC HI POT test. Record data in Attachment B-1 or equivalent form that contains the requirements of Attachment B-1.

3.5.12 Connect the windings permanently.

3.5.12.1 Repeat tests described in 3.5.8 through 3.5.11. Record data in Attachment B-1 or equivalent form that contains the requirements of Attachment B-1.

3.5.13 Select varnish methods and material. Maintain the varnish in accordance with the varnish manufacturer's instructions. Maintain a current revision of the varnish manufacturer's instructions on storage, maintenance, and use of the type of varnish to be applied. Maintain a record of varnish temperature, viscosity, and, for solventless varnish, gel time tests. Tests must show varnish is within varnish manufacturer's recommendations and have been accomplished in the intervals specified by the varnish manufacturer. The record must also show the varnish is being stored as recommended by the varnish manufacturer. Record data in Attachment B-1 or equivalent form that contains the requirements of Attachment B-1.

3.5.14 Insulate the windings using the Vacuum Pressure Impregnation (VPI) procedure. Do not immerse the leads. Wipe surfaces that affect assembly such as rabbet fits and mounting flanges with a cloth moistened with a solvent after draining and before baking.

3.5.15 Bake windings. Remove excess varnish runoff from the component locations described in 3.5.14 after final baking.

3.5.16 Prime equipment housing, fan(s), and end bells with one coat F-84 Alkyd Zinc Molybdate TT-P-645 (1.5 mils dry film thickness).

3.5.17 Submerge wound assembly in fresh water for 24 hours. Accomplish a Submerged Insulation test. Record data in Attachment B-1 or equivalent form that contains the requirements of Attachment B-1.

3.5.18 Repeat test described in 3.5.8. Record data in Attachment B-1 or equivalent form that contains the requirements of Attachment B-1.

3.5.19 Accomplish an AC HI POT test. Record data in Attachment B-1 or equivalent form that contains the requirements of Attachment B-1.

3.5.20 Repeat test described in 3.5.10. Record data in Attachment B-1 or equivalent form that contains the requirements of Attachment B-1.

3.5.21 Repeat test described in 3.5.8. Record data in Attachment B-1 or equivalent form that contains the requirements of Attachment B-1.

3.5.22 Measure resistance value of each winding temperature detector, using a low voltage ohmmeter. Record data in Attachment B-1 or equivalent form that contains the requirements of Attachment B-1.

3.6 Accomplishment of the balancing requirement for each rotating assembly must be in accordance with NAVSEA Standard Items. (See Note 4.9).

3.7 Install identification markers on wiring in the external connection box.

3.7.1 Ensure markers must be aluminum wrap-around type with metal stamped or embossed markings.

3.8 Repair lightly scored areas of frame, end bells, and shaft by manual methods. Recondition threads and fit key to keyway. Step keys must not be used. Apply a thin coat of petrolatum to unpainted mating surfaces except for explosion-proof motors that must have clean, dry mating surfaces.

3.9 Prepare and refinish equipment. Protect machine surfaces, windings, and nameplates from being painted or otherwise damaged.

3.9.1 Accomplishment of cleaning and painting for housing, fan, and interior and exterior of each end bell must be in accordance with NAVSEA Standard Items (See Note 4.8).

3.10 Accomplish the following on equipment having other than sleeve-type bearings unless otherwise specified in the invoking Work Item, using 2.9 for guidance.

3.10.1 Install new bearings, seals, fittings, lock washers, and locknuts conforming to 2.3, using 2.7 and Chapter 6 of 2.9 for guidance, except as indicated in 3.10.1.1 (utilizing Attachment A for guidance).

3.10.1.1 Install Type 111, Class 8 (double seal) bearings in motors meeting the criteria identified in Chapter 6 of 2.9. Only double seal bearings identified in Chapter 6 of 2.9 are acceptable for this use.

3.10.1.2 Install Type 111, Class 8 (double seal) bearings with a C3 (greater than normal) radial internal clearance in place of the Type 111 bearing originally furnished, for vaneaxial and tubeaxial fan motors not meeting the criteria of Chapter 6 of 2.9, if not originally furnished or already accomplished during previous repair. Install Type 120 bearings in vaneaxial and tubeaxial fan motors originally furnished with Type 120 bearings.

3.10.1.3 Install new label plates with the inscription "DO NOT LUBRICATE" on equipment using double seal bearings (Type 111, Class 8 or Type 120).

3.10.1.4 Install pipe plugs on all grease fills and drains, for equipment converted from re-lubricable bearings to double seal bearings.

3.10.1.5 Prepare a report that reflects the change in the maintenance requirements for the converted motor, for equipment converted from lubricated bearings to double seal bearings. Record data in Attachment B-1 or equivalent form that contains the requirements of Attachment B-1.

3.10.2 Lubricate bearings with grease conforming to DOD-G-24508 as required in Paragraphs 244-1.7.7.2 and 244-1.7.7.3 of 2.8, for equipment not using double seal bearings.

3.11 Assemble the equipment, using 2.3 and 2.5 through 2.9 for guidance. Do not use materials containing silicone in the repair and reassembly of equipment with commutator or collector rings. Install new gasket on covers, inspection plates, and between the external connection box and the frame. Gaskets must conform to MIL-PRF-1149 unless otherwise specified in 2.3. Set brush holders not less than 1/16-inch or more than 1/8-inch from commutator or collector rings unless otherwise specified in 2.2; set in electrical neutral plane and stagger brushes for maximum coverage of the commutator in accordance with paragraph 6-3.5 through 6-3.5.4 of 2.5; center over the collector rings; ensure the brushes do not extend beyond the edge of the collector ring; install new brushes in accordance with 2.3; sand new brushes to fit curvature of the commutator or collector rings; ensure brushes have a surface contact of 100 percent and are not chipped, cracked, or broken; remove sand, carbon, and other foreign matter resulting from fitting new brushes; adjust spring tension of brushes. Adjust air gap as specified in 2.3, plus or minus 10 percent. Rotate shaft by hand a minimum of 3 revolutions. Rubbing or binding of rotating assembly must not be allowed. Record data in Attachment C or equivalent form that contains the requirements of Attachment C.

3.11.1 Install labels plate conforming to MIL-DTL-15024 for those identified to be missing or damaged.

3.12 Accomplish a no-load shop test of the equipment for a minimum of one-half hour. Verify proper direction of rotation. After one-half hour, measure current and voltage in each phase, speed and bearing temperature rise measured on the equipment's exterior near each bearing. Record data in Attachment B-1 or equivalent form that contains the requirements of Attachment B-1.

3.13 Accomplish an operational test, of the assembled vaneaxial/tube axial fan, for one hour after bearing and stator temperatures stabilize within one degree C for three consecutive 15-minute intervals. Verify proper direction of rotation. Measure current, voltage, frame and bearing temperature rise and speed at 15-minute intervals. Bearing temperatures must not exceed 180 degrees Fahrenheit, unless otherwise specified in the invoking Work Item or equipment technical manual. Measure hot insulation resistances of winding to ground immediately upon completion of the operational shop test, using a 500-volt megger. Record data in Attachment B-1 or equivalent form that contains the requirements of Attachment B-1.

3.14 Submit one legible copy, in approved transferrable media, of a report listing data recorded in 3.5.1, through 3.5.2.3, 3.5.5 through 3.5.13, 3.5.17 through 3.5.22, 3.10.1.5, and 3.11 through 3.13 to the SUPERVISOR.

3.15 Install equipment. Install new gaskets conforming to MIL-PRF-900 on disturbed ventilation. Align equipment in accordance with 2.3. Measure and record facial and peripheral coupling data. Install chocks, shims, shock mounts, and sound damping pads. Connect electrical cables/wiring. Bond and ground equipment in accordance with 2.11, using new ground straps. Rotate shaft by hand a minimum of 3 revolutions. Rubbing or binding of rotating assembly not allowed. Measure the air gap and bearing clearance (sleeve bearing equipment only), insulation resistance (at 500 volts DC), and thrust. Added another sentence to paragraph. Record data in Attachment B-2 or equivalent form that contains the requirements of Attachment B-2.

3.15.1 Accomplishment of pump and driver shaft alignment must be in accordance with NAVSEA Standard Items (See Note 4.10).

(V)(G) "OPERATIONAL TEST"

3.16 Accomplish an operational test of the assembled equipment at full system capacity for a minimum of one hour after bearing and stator temperatures stabilize within one degree C for three consecutive 15 minute intervals, unless otherwise specified in the invoking Work Item. If temperatures do not stabilize in four hours, stop test and contact the SUPERVISOR. Verify proper direction of rotation. Measure current, voltage, frame and bearing temperature rise, and speed at 15-minute intervals. Frame and bearing temperature rise and speed is not required for vaneaxial and tubeaxial fan assemblies. Bearing temperatures must not exceed 180 degrees Fahrenheit unless otherwise specified in the invoking Work Item/equipment technical manual. Record data in Attachment B-2 or equivalent form that contains the requirements of Attachment B-2.

3.16.1 Accomplish the requirements of 3.17 twice for two speed motors, once while operating at low speed, and once while operating at high speed. Record data in Attachment B-2 or equivalent form that contains the requirements of Attachment B-2.

3.16.2 Accomplish the requirements of 3.17 for limited duty motors, for a period of time equal to the duty cycle of the motor. For motors with a duty cycle equal to or less than 30 minutes, measure data every 10 minutes. Record data in Attachment B-2 or equivalent form that contains the requirements of Attachment B-2.

3.16.3 Measure hot insulation resistance of windings to ground immediately upon completion of test using 500 volt megger... Record data in Attachment B-2 or equivalent form that contains the requirements of Attachment B-2.

3.17 Submit one legible copy, in hard copy or approved transferrable media, of a report listing data recorded in 3.2.1, 3.2.2, 3.4, 3.15, and 3.16 through 3.16.3 to the SUPERVISOR.

4. NOTES:

4.1 This Standard Item is concerned primarily with the requirements to rewind rotating electrical equipment with a SIS in accordance with 2.2. Each Certified Repair Activity has developed a SIS Rewind Procedure (SISRP) that has been reviewed, approved by and filed with NAVSEA. In most cases, these Repair Activity SISRPs are treated as proprietary and may not be available to the SUPERVISOR for process review. The NAVSEA approved Repair Activity SISRP is the guiding document by which the equipment is to be rewound and supersedes any specification detailed in this Standard Item.

4.2 Equipment technical manual, Allowance Parts List (APL) (if applicable) and drawings will be listed in the invoking Work Item.

4.3 Shop test of generator will be addressed in the invoking Work Item.

4.4 For the current list of NAVSEA-certified facilities for Vacuum Pressure Insulation (VPI) Sealed Insulation Systems, contact Naval Surface Warfare Center Carderock Division, Department 934, Phone (215) 897-7245.

4.5 Utilize Attachment A for determination if the Navy's motor bearing conversion program for Extended Life Double Seal (ELDS) ball bearings is permissible.

4.6 Data received in 3.11.1.5 must be forwarded to the SUPERVISOR for the purpose of initiating action ensuring shipboard databases such as the Equipment Guidance List (EGL) are updated to reflect the change in maintenance requirements for converted motors. Additionally, where APL changes are initiated to convert to ELDS bearings, a COSAL feedback report must be submitted, providing the NSN and part number for the ELDS bearing by the SUPERVISOR. Utilize the following website to initiate changes to Technical Manuals, APLs, etc.:  
<http://www.navy311.navy.mil>.

4.7 MIL-B-17931 (Bearings, Ball, Annular, For Quiet Operation) bearings are considered to be Long Lead Time (LLT) material. It is recommended these bearings be provided as Government Furnished Material (GFM).

4.8 If cleaning and painting of 3.4.1, 3.5.4, or 3.10.1 is required; the use of Category II Standard Item 009-32 "Cleaning and Painting Requirements; accomplish" of 2.1 will be specified in the Work Item.



4.9 If balancing of rotating equipment of 3.7 is required; the use of Category II Standard Item 009-15 “Rotating Machinery; balance” of 2.1 will be specified in the Work Item.

4.10 If pump and driver shaft alignment of 3.16.1 is required; the use of Category II Standard Item 009-58 “Pump and Driver Shaft Alignment; accomplish” of 2.1 will be specified in the Work Item.

4.11 If having difficulty determining motor Service Class, utilize 2.12 as a guide.

## ATTACHMENT A

1. To reduce motor maintenance and repair costs, the NAVY has implemented a program that allows for the use of Extended Life Double Seal (ELDS) bearings.

2. LIMITATIONS: The ELDS program does NOT apply to motors that are under the cognizance of NAVSEA 08.

3. APLs for motors meeting the conversion criteria requirements have been modified to identify ELDS bearings. In these cases, the APL bearing criteria will override any specifications delineated in the equipment technical manual or the motor "Original Equipment Manufacturer (OEM)" drawings. If ELDS bearings are not indicated in an APL, the following motor criteria must meet the applicability specifications for motors to undergo conversion to ELDS bearings:

3.a Motor must be installed on a surface ship and must NOT be under the cognizance of NAVSEA 08.

3.b Commercial motors are not eligible. Motors must have been furnished to the NAVY in accordance with MIL-DTL-17060 (Motors, Alternating Current, Integral Horsepower, Shipboard use), MIL-M-17413 (Motors, Direct Current, Integral H.P., Naval Shipboard [NAVY]) or MIL-M-17059 (Motors, 60 Cycle, Alternating Current Fractional H.P. [Shipboard Use]).

3.c Motors using one or more noise-quiet bearings per MIL-B-17931 (Bearings, Ball, Annular, For Quiet Operation) are NOT eligible for ELDS conversion.

3.d Bearings originally furnished with the motor must be type 111 bearings per FF-B-171. Motors are NOT to be considered as candidates for ELDS conversion in situations where the equipment technical manual and/or the OEM motor drawings originally specified FF-B-171 bearings but have notes indicating that replacement bearings are to be in accordance with MIL-B-17931 (Bearings, Ball, Annular, For Quiet Operation).

3.e The use of ELDS bearings is limited to motors where the full load speed and the size of both bearings are as follows:

1. Maximum bearing size 306 or 206 and full load rpm between 1,801 and 3,600 rpm.
2. Maximum bearing size 313 or 213 and full load rpm between 1,201 and 1,800 rpm.
3. Maximum bearing size 318 or 218 and full load rpm less than 1200 rpm.

4. The repair process using ELDS bearings includes the following requirements:

4.a Only ELDS bearings, in accordance with the following table (Attachment A / Table 1), can be used. Other double seal bearings will not provide an acceptable bearing life.

Attachment A / Table 1

ELDS Bearings NSNs and Part Numbers

SIZE	P/N	NSN
201	6201-2RS1C3/GHY	3110-01-492-0221
202	6202-2RS1C3/GHY	3110-01-491-0233
203	6203-2RS1C3/GHY	3110-01-491-0234
204	6204-2RS1C3/GHY	3110-01-491-6636
205	6205-2RS1C3/GHY	3110-01-451-9166
206	6206-2RS1C3/GHY	3110-01-451-9165
207	6207-2RS1C3/GHY	3110-01-451-9164
208	6208-2RS1C3/GHY	3110-01-451-9170
209	6209-2RS1C3/GHY	3110-01-451-9252
210	6210-2RS1C3/GHY	3110-01-492-1831
211	6211-2RS1C3/GHY	3110-01-518-0937
303	6303-2RS1C3/GHY	3110-01-493-3750
304	6304-2RS1C3/GHY	3110-01-451-9153
305	6305-2RS1C3/GHY	3110-01-451-9158
306	6306-2RS1C3/GHY	3110-01-451-9159
607	6307-2RS1C3/GHY	3110-01-451-9161
308	6308-2RS1C3/GHY	3110-01-451-9167
309	6309-2RS1C3/GHY	3110-01-451-9168
310	6310-2RS1C3/GHY	3110-01-490-6683
311	6311-2RS1C3/GHY	3110-01-492-0223
312	6312-2RS1C3/GHY	3110-01-490-6848
313	6313-2RS1C3/GHY	3110-01-492-0191
314	6314-2RS1C3GHY	3110-01-492-0226
315	6315-2RS1C3/GHY	3110-01-494-0993
316	6316-2RS1C3/GHY	3110-01-492-0188
317	6317-2RS1C3/GHY	3110-01-492-0219
318	6318-2RS1C3/GHY	3110-01-493-3749

4.b Both bearings of each converted motor must be ELDS bearings.

4.c A label plate must be permanently attached to the motor indicating "Do Not Lubricate".

4.d Grease fills and drains, if present, must be fitted with a pipe plug, securely fastened. Fittings to accommodate grease guns must be replaced with pipe plugs."

ATTACHMENT B-1

Ship name:

Hull number:

Work item number:

Date:

Motor nameplate data.

Manufacture:

Amperage (AMP):

Model number:

Horsepower (HP):

NSN:

Revolutions per minute (RPM):

S/N:

Winding (WDG):

Frame:

Maximum ambient temperature (AMB):

Volt:

Insulation class:

Phase:

Duty:

Hertz (HZ):

Drawing number (DWG):

Field changes:

Additional nameplate data:

ATTACHMENT B-1

3.5.1 Core Loss test.

SAT		UNSAT	
Test equipment:			
Findings:			

3.5.1.1 Loop test.

SAT		UNSAT	
Test Equipment:			
Findings:			

3.5.1.2 Hot spot inspection with core loss tester.

SAT		UNSAT	
Test Equipment:			
Findings:			

3.5.2 Core inspection.

SAT		UNSAT	
Findings:			

3.5.2.1 Core temperature limitations.

Manufacture core data:		°F
Thermocouple data:		°F
Findings:		

ATTACHMENT B-1

3.5.2.2 Winding data.

As found winding data:	
Manufacture winding data:	

3.5.2.3 Post winding removal core loss, loop test and hot spot inspection.

- Core Loss test.

SAT		UNSAT	
Test equipment:			
Findings:			

- Loop test.

SAT		UNSAT	
Test Equipment:			
Findings:			

- Hot spot inspection with core loss tester.

SAT		UNSAT	
Test Equipment:			
Findings:			

ATTACHMENT B-1

3.5.5 Rotor inspection.

SAT		UNSAT	
Findings:			

3.5.7 Installed winding and temperature detector data.

Findings:	

3.5.8 500-volt megger insulation resistance test.

Lead	Acceptance Criteria	Measured	SAT	UNSAT
	MΩ	MΩ		
	MΩ	MΩ		
	MΩ	MΩ		
Findings:				

3.5.9 Phase resistance balance test.

Phase	Acceptance Criteria	Measured	SAT	UNSAT
	Ω	Ω		
	Ω	Ω		
	Ω	Ω		
Findings:				

3.5.10 Voltage surge test.

Circuit Tested	Test Voltage	Error Ratio	SAT	UNSAT
	V	%		
	V	%		
	V	%		
Findings:				

ATTACHMENT B-1

3.5.11 DC HI POT test.

Circuit Tested	Test Voltage	Leakage Current	SAT	UNSAT
	V	uA		
	V	uA		
	V	uA		
Findings:				

3.5.12.1 Post winding permanent connection.

- 500-volt megger insulation resistance test.

Lead	Acceptance Criteria	Measured	SAT	UNSAT
	MΩ	MΩ		
	MΩ	MΩ		
	MΩ	MΩ		
Findings:				

- Phase resistance balance test.

Phase	Acceptance Criteria	Measured	SAT	UNSAT
	Ω	Ω		
	Ω	Ω		
	Ω	Ω		
Findings:				

- Voltage surge test.

Circuit Tested	Test Voltage	Error Ratio	SAT	UNSAT
	V	%		
	V	%		
	V	%		
Findings:				

- DC HI POT test.

Circuit Tested	Test Voltage	Leakage Current	SAT	UNSAT
	V	uA		
	V	uA		
	V	uA		
Findings:				



ATTACHMENT B-1

3.5.13 Varnish methods and materials.

Manufacture varnish type and instructions:	

3.5.17 Submerged insulation resistance test.

Lead	Acceptance Criteria	Measured	SAT	UNSAT
	MΩ	MΩ		
	MΩ	MΩ		
	MΩ	MΩ		
Findings:				

3.5.18 500-volt megger insulation resistance test.

Lead	Acceptance Criteria	Measured	SAT	UNSAT
	MΩ	MΩ		
	MΩ	MΩ		
	MΩ	MΩ		
Findings:				

3.5.19 AC HI POT test.

Circuit Tested	Test Voltage	Leakage Current	SAT	UNSAT
	V	mA		
	V	mA		
	V	mA		
Findings:				

ATTACHMENT B-1

3.5.20 Voltage surge test.

Circuit Tested	Test Voltage	Error Ratio	SAT	UNSAT
	V	%		
	V	%		
	V	%		
Findings:				

3.5.21 500-volt megger insulation resistance test.

Lead	Acceptance Criteria	Measured	SAT	UNSAT
	MΩ	MΩ		
	MΩ	MΩ		
	MΩ	MΩ		
Findings:				

3.5.22 Resistance value of each winding temperature detector, heater, and heater strip.

Circuit Tested	Acceptance Criteria	Measured	SAT	UNSAT
	Ω	Ω		
	Ω	Ω		
	Ω	Ω		
Findings:				

3.10.1.5 Maintenance requirement change for double seal bearing conversion.

Findings:	

3.12 No-load shop test.

Direction of Rotation	CW		CCW	
Speed				RPM
Current			Volts	
T1	A	T1		V
T2	A	T2		V
T3	A	T3		V
Bearing Temperature				
Coupled End				°F
Free End				°F

ATTACHMENT B-1

3.13 Operational shop test of assembled vaneaxial/tubeaxial fan.

Direction of Rotation	CW		CCW	
Speed	RPM			
Current	Volts			
T1	A	T1	V	
T2	A	T2	V	
T3	A	T3	V	
Bearing Temperature				
Coupled End	°F			
Free End	°F			
500-volt megger insulation resistance test				
Lead	Acceptance Criteria	Measured	SAT	UNSAT
	MΩ	MΩ		
	MΩ	MΩ		
	MΩ	MΩ		

ATTACHMENT B-2

Ship name:

Hull number:

Work item number:

Date:

Motor nameplate data.

Manufacture:

Amperage (AMP):

Model number:

Horsepower (HP):

NSN:

Revolutions per minute (RPM):

S/N:

Winding (WDG):

Frame:

Maximum ambient temperature (AMB):

Volt:

Insulation class:

Phase:

Duty:

Hertz (HZ):

Drawing number (DWG):

Field changes:

Additional nameplate data:

ATTACHMENT B-2

3.2.1 Preliminary inspection.

SAT		UNSAT	
Findings:			

3.2.2 List of accessories.

Findings:	

3.4 Foundation structural inspection.

SAT		UNSAT	
Findings:			

3.15 Post installation 500-volt megger insulation resistance test.

Lead	Acceptance Criteria	Measured	SAT	UNSAT
	MΩ	MΩ		
	MΩ	MΩ		
	MΩ	MΩ		
Findings:				

ATTACHMENT B-2

3.16 Operational test of the assembled equipment at full system capacity.

Direction of Rotation	CW		CCW	
Speed				
	RPM			
15 Minutes				
Current		Volts		
T1	A	T1		V
T2	A	T2		V
T3	A	T3		V
Bearing Temperature				
Coupled End				°F
Free End				°F
30 Minutes				
Current		Volts		
T1	A	T1		V
T2	A	T2		V
T3	A	T3		V
Bearing Temperature				
Coupled End				°F
Free End				°F
45 Minutes				
Current		Volts		
T1	A	T1		V
T2	A	T2		V
T3	A	T3		V
Bearing Temperature				
Coupled End				°F
Free End				°F
One Hour				
Current		Volts		
T1	A	T1		V
T2	A	T2		V
T3	A	T3		V
Bearing Temperature				
Coupled End				°F
Free End				°F

ATTACHMENT B-2

3.16.1 Operational test of the assembled equipment at full system capacity, two speed motor.

Direction of Rotation	CW		CCW	
Speed				
	RPM			
15 Minutes				
Current		Volts		
T4	A	T4		V
T5	A	T5		V
T6	A	T6		V
Bearing Temperature				
Coupled End				°F
Free End				°F
30 Minutes				
Current		Volts		
T4	A	T4		V
T5	A	T5		V
T9	A	T6		V
Bearing Temperature				
Coupled End				°F
Free End				°F
45 Minutes				
Current		Volts		
T4	A	T4		V
T5	A	T5		V
T6	A	T6		V
Bearing Temperature				
Coupled End				°F
Free End				°F
One Hour				
Current		Volts		
T4	A	T4		V
T5	A	T5		V
T6	A	T6		V
Bearing Temperature				
Coupled End				°F
Free End				°F

ATTACHMENT B-2

3.16.2 Operational test of the assembled equipment at full system capacity, limited duty motor.

Direction of Rotation	CW		CCW	
Speed	RPM			
Duty Cycle or 10 Minutes as applicable.				
Current		Volts		
T1	A	T1	V	
T2	A	T2	V	
T3	A	T3	V	
Bearing Temperature				
Coupled End	°F			
Free End	°F			
20 Minutes as applicable.				
Current		Volts		
T1	A	T1	V	
T2	A	T2	V	
T3	A	T3	V	
Bearing Temperature				
Coupled End	°F			
Free End	°F			
30 Minutes as applicable.				
Current		Volts		
T1	A	T1	V	
T2	A	T2	V	
T3	A	T3	V	
Bearing Temperature				
Coupled End	°F			
Free End	°F			

3.16.3 Post installation 500-volt megger hot insulation resistance test.

Lead	Acceptance Criteria	Measured	SAT	UNSAT
	MΩ	MΩ		
	MΩ	MΩ		
	MΩ	MΩ		
Findings:				



ATTACHMENT C

SHIP NAME & HULL NUMBER

/ /  
MONTH/DAY/YEAR

MOTOR LOCATION (i.e., NO.2 MAIN FEED PUMP, etc.)

HOUSING DIAMETERS

<u>DRIVE END</u>			
	<u>A</u>	<u>B</u>	<u>C</u>
<u>1</u>			
<u>2</u>			
<u>3</u>			

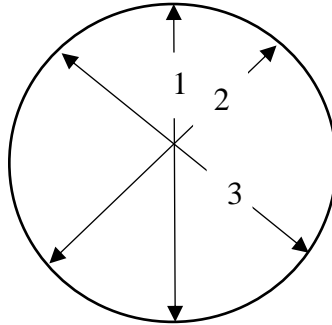

OUTER INNER

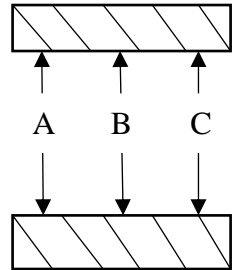

<u>OUTER END</u>			
	<u>A</u>	<u>B</u>	<u>C</u>
<u>1</u>			
<u>2</u>			
<u>3</u>			

SHAFT DIAMETERS

<u>DRIVE END</u>			<u>OUTER END</u>			
	<u>A</u>	<u>B</u>	<u>C</u>	<u>A</u>	<u>B</u>	<u>C</u>
1						
2						
3						

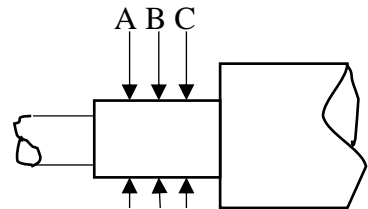
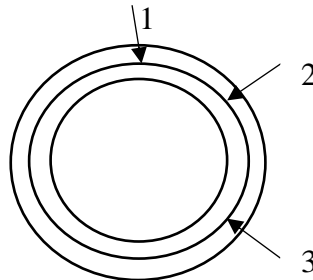

A. SHAFT RADIAL RUNOUT \_\_\_\_\_

B. FACE RUNOUT, BEARING INNER RING

DRIVE END \_\_\_\_\_

OUTER END \_\_\_\_\_

C. FACE RUNOUT, BEARING OUTER RING \_\_\_\_\_

DRIVE END \_\_\_\_\_

OUTER END \_\_\_\_\_

MECHANICAL CONDITION  
(LOSS OF LUBE, BURNED ETC.)

\_\_\_\_\_  
\_\_\_\_\_

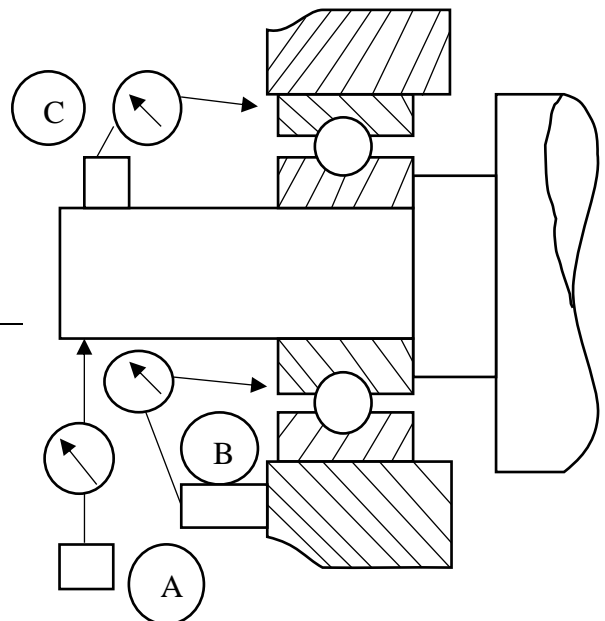

NAVSEA  
STANDARD ITEM

FY-24

ITEM NO: 009-114  
DATE: 25 OCT 2022  
CATEGORY: II

1. SCOPE:

1.1 Title: Mold Remediation; accomplish

2. REFERENCES:

2.1 EPA 402-K-01-001, Mold Remediation in Schools and Commercial Buildings

2.2 29 CFR Part 1915, Occupational Safety and Health Standards for Shipyard Employment

3. REQUIREMENTS:

3.1 Conduct and document an initial determination of potential personnel exposure to materials contaminated with mold or mold spores prior to the start of work.

3.1.1 Provide a copy of the documentation, signed by a Competent Person as defined in 29 CFR 1915.4, to the SUPERVISOR upon request.

3.2 Ensure the remediation of material contaminated with mold or mold spores meets the guidance provided in 2.1.

3.3 Provide a notice and remediation plan to the SUPERVISOR and to the Commanding Officer's designated representative prior to start of work.

3.3.1 The remediation plan must be on the work site and include at a minimum the following information:

3.3.1.1 Scope and location of the remediation area.

3.3.1.2 Method(s) to be used to remediate material contaminated with mold or mold spores.

3.3.1.3 List of Personal Protective Equipment (PPE) in accordance with 2.2 to be used during remediation process.

3.3.1.4 Engineering controls (i.e., ventilation and containment) to be used to eliminate exposure to personnel and other spaces/compartments.

3.3.2 Post a notice at the ship's Quarterdeck and at all entrances to the work areas for each job or separate area of potential exposure to mold or mold spore remediation operations at least 4 hours, but not more than 24 hours, prior to the start of work.

3.3.3 The notice must contain the following information:

3.3.3.1 Ship's name and hull number

3.3.3.2 Work Item number

3.3.3.3 Compartment or frame number

3.3.3.4 Identification of hazard

3.3.3.5 Date and time of work process

3.3.3.6 Identification of engineering and work practice controls

3.3.4 Deliver notification of work planned over a weekend or Monday following that weekend to the Commanding Officer's designated representative not later than 0900 on the Friday immediately preceding that weekend.

3.3.5 Deliver notification of work planned on a Federal holiday and on the day following the Federal holiday to the Commanding Officer's designated representative not later than 0900 on the last working day preceding the Federal holiday.

3.3.6 The notice and remediation plan must be submitted to the SUPERVISOR for review prior to commencement of the work operation. Authorization of the SUPERVISOR must be obtained before proceeding with the work.

3.4 Provide for isolation and blanking of ship's ventilation systems in work areas to prevent mold or mold spore contamination of ventilation systems or other compartments/spaces.

3.5 Post warning signs and establish regulated areas for monitoring and authorized personnel entry.

3.6 Visually monitor the affected areas during work operations to ensure compliance with 2.1 and 2.2. Monitoring must include adjacent spaces to ensure the work area containments and work practices are effective. Results of surveillance must be documented and documentation must be made available to the SUPERVISOR.

(V)(G) "FINAL INSPECTION"

3.7 Conduct a final visual inspection jointly with the SUPERVISOR and Commanding Officer's designated representative to verify that all visible mold and mold-damaged materials have been removed.

4. NOTES:

4.1 Reference 2.1 is available at [http://www.epa.gov/mold/mold\\_remediation.html](http://www.epa.gov/mold/mold_remediation.html)

NAVSEA  
STANDARD ITEM

FY-24

ITEM NO: 009-115  
DATE: 25 OCT 2022  
CATEGORY: II

1. SCOPE:

1.1 Title: Bearing Rebabbiting; accomplish

2. REFERENCES:

2.1 Standard Items

2.2 SL460-AA-HBK-010, Handbook for Inspection, Packaging, Handling, Storage and Transportation

2.3 DOD-STD-2188, Babbiting of Bearing Shells (METRIC)

2.4 T9074-AS-GIB-010/271, Requirements for Nondestructive Testing Methods

3. REQUIREMENTS:

3.1 Crate and secure each bearing identified in the work item. Packaging must conform to 2.2. Reuse crate for return shipping.

3.1.1 Ship crated material prepaid to and from the contractor's facility.

(I)(G)" SHIPPING CRATE INSPECTION"

3.1.2 Prior to packing and crating, visually inspect the crate for conformance and proper packaging and securing of each bearing.

3.2 Accomplishment of a Process Control Procedure (PCP) for the process of rebabbiting each bearing must be in accordance with NAVSEA Standard Items (See Note 4.3), each bearing drawing, 2.3, and ASTM B339. The PCP must provide for accomplishment of all steps from receipt inspection to final dimensional inspection and verify compliance with and documentation of the following steps:

3.2.1 Receipt inspection of babbitt and tin to the requirements of 2.3 and ASTM B339.

3.2.2 Receipt inspection of bearing

- 3.2.3 Removal of existing babbit
- 3.2.4 Bearing shell machining
- 3.2.5 Bearing shell cleanliness
- 3.2.6 Bearing shell fluxing
- 3.2.7 Bearing shell tinning temperatures
- 3.2.8 Bearing shell babbitting, centrifugal and or static
- 3.2.9 Centrifugal casting rotation speed
- 3.2.10 Static casting rodding
- 3.2.11 Pouring babbit temperatures of babbit and bearing shell
- 3.2.12 Post babbit machining

(I)(G) “VERIFICATION OF BOND”

3.2.13 Bond testing in accordance with DOD-STD-2188 and 2.4.

3.2.14 Final inspection to determine conformance to referenced drawing dimensional requirements.

(I)(G) “SHIPPING CRATE INSPECTION”

3.2.15 Packaging and crating inspection and conformance to 2.2 packaging requirements.

3.3 Submit one legible copy, in hard copy or approved transferrable media, of the PCP with all substantiating documents within one day of completion of the requirements of 3.2.15. Provide one additional legible hard copy of the completed PCP with the bearing when shipped.

4. NOTES:

4.1 Known source: American Metal Bearing Company  
7191 Acacia Avenue,  
Garden Grove, CA 92841-5297  
Contact number; 714-892-5527 or 800-888-3048

4.2 If drawing for bearing is not available, invoke NSI 009-90 to ensure bearing is correctly refurbished in conformance with equipment manufacturer’s requirements and specifications.

4.3 If a Process Control Procedure (PCP) for the process of reabbtting each bearing in 3.2 is required; the use of Category II Standard Item 009-09 “Process Control Procedure (PCP); provide and accomplish” of 2.1 will be specified in the Work Item. If reabbtting is accomplished by the OEM or other NAVSEA approved organization, a NAVSEA approved process may be used in lieu of a PCP.

NAVSEA  
STANDARD ITEM

FY-24

ITEM NO: 009-116  
DATE: 25 OCT 2022  
CATEGORY: II

1. SCOPE:

1.1 Title: Waste Heat Boiler Sodium Nitrate Wet Layup; accomplish

2. REFERENCES:

2.1 S9086-GX-STM-020/CH-220, Boiler Water/Feedwater Test and Treatment

3. REQUIREMENTS:

3.1 Accomplish sodium nitrite wet layup of each auxiliary/waste heat boiler.

3.2 Notify the SUPERVISOR one day prior to layup of each boiler.

3.3 The sodium nitrite layup solution must be prepared with sufficient solution to fill boiler and to provide a reservoir in a pier side tank or ship's feedwater tank.

3.3.1 For each 100-gallons of feed quality water (conductivity maximum of 15-micromho/cm) to be treated, dissolve one pound of sodium nitrite in accordance with Paragraphs 220-29.24.3 and 220-30.29.4 of 2.1.

3.3.1.1 Mixing is accomplished by dissolving the sodium nitrite in feed quality water (10 pounds will dissolve in 2-gallons of water), and then adding the dissolved chemicals to the feedwater in the tank. The tank is then circulated for 30-minutes to mix the solution.

3.3.2 A head tank is the easiest and preferred method of maintaining positive pressure. If a head tank method is used, locate and pipe the head tank above the highest boiler vent.

3.3.3 Fill the boiler with the sodium nitrite layup solution and maintain pressure using a head tank or feed pump.

3.3.4 Provide an authorized source of heat to the fireside/gas-side areas to prevent corrosion in accordance with 2.1.

3.4 Layup is lost when the head tank level or pump discharge pressure is not maintained



and cannot be reestablished. Apply dry layup if layup is lost.

3.5 To prepare for boiler operation, dump the boiler, feed tanks and associated piping. Flush by refilling the boiler, feed tanks, and associated piping with feed-quality water. Do not light-off with sodium nitrite layup solution in the boiler, DFT (if applicable) or feed tank. Dispose of removed solution in accordance with local, state, and federal regulations.

3.5.1 Do not drain the solution to the bilge.

4. NOTES:

4.1 None.

NAVSEA  
STANDARD ITEM

FY-24

ITEM NO: 009-117  
DATE: 25 OCT 2022  
CATEGORY: I

1. SCOPE:

1.1 Title: Combat Systems, Light-Off Support; provide

2. REFERENCES:

2.1 Standard Items

2.2 S9095-AD-TRQ-010/TSTP, Total Ship Test Program

3. REQUIREMENTS:

3.1 Complete work in designated compartments and support systems prior to the Command, Control, Communications, Computer, Combat Systems and Intelligence (C5I) Light-Off (C5ILO) Key Event to the degree required to support uninterrupted completion of government AIT installations as well as all Stage 3 and follow-on C5I tests. Stage test definitions are detailed in 2.2. Designated compartments and support systems required to support AIT production and testing are listed in a Compartment Release Schedule (CRS) which is provided to the Lead Maintenance Activity (LMA) by the SUPERVISOR as Government Furnished Information (GFI). The selected Stage 3 through 7 or Operational Verification Tests to be conducted during the C5I Light-Off period are to be identified in the LMA's Integrated Test Schedule (ITS) required by SI 009-67 of 2.1.

3.1.1 Obtain from the SUPERVISOR, no later than A-30, a C5I Compartment Release Schedule (CRS), indicating compartments and Combat Systems Support Equipment (CSSE) required in support of C5I Light-Off.

3.1.2 Ensure all work and testing required to meet CRS dates are fully integrated into the Integrated Production Schedule (IPS) and Integrated Test Schedule (ITS) required by 009-60 and 009-67 of 2.1. Include all work and testing planned for accomplishment by all organizations involved including Commercial Industrial Services (CIS), Alteration Installation Teams (AIT), Ships Force, Government-Contracted Third Party Maintenance Providers, and Fleet Maintenance Activity (FMA).

3.2 Release compartments to the Government no later than the dates indicated in the approved CRS.

3.2.1 Submit one legible copy, in approved transferrable media, of a report listing the status of CRS completion including a list of preliminary C5I Light-Off discrepancies to the SUPERVISOR weekly beginning at the 50 Percent Review Conference. Submission can be concurrent with reports required by 009-60 and 009-81 of 2.1.

3.2.2 Notify the SUPERVISOR immediately upon determination of any discrepancies that cannot be corrected prior to scheduled compartment release dates for each compartment. Include the reason for the discrepancy and when applicable, highlight the new expected completion date on a revised CRS.

(V)(G)“JOINT INSPECTION”

3.2.3 Accomplish a joint inspection of the compartments to be released with the SUPERVISOR, PEO IWS designated Combat Systems Project Engineer (if assigned), and Ship's Commanding Officer (or designated representative), upon completion inspection, and acceptance of industrial work and prior to the required release date per the CRS.

3.2.3.1 Acceptance criteria is completion of 3.2.3.2 through 3.2.3.3.

3.2.3.2 The joint inspection team must document the discrepancies and determine if the scope and nature of work to correct the discrepancies will impede uninterrupted testing. This inspection may be conducted in conjunction with 009-81 of 2.1.

3.2.3.3 Identify each discrepancy as contractor responsible or government responsible. Develop and implement a discrepancy correction plan for contractor responsible discrepancies identified during the compartment inspection process that allows the release of compartments to the government in support of government responsible work.

3.2.3.4 Submit one legible copy, in approved transferrable media, of a report listing the discrepancies identified during each inspection that will impede testing and the discrepancies identified that will not impede testing, to the SUPERVISOR.

3.2.3.5 Ensure the joint inspection team identified in 3.2.3 will sign the report upon completion of discrepancy correction.

3.2.4 Allow no work in compartments released to the government until the end of the availability without written permission of the SUPERVISOR.

3.3 All industrial work in compartments and work on CSSE listed on the CRS must be complete to the degree that allows for the safe and uninterrupted operation and testing of the ship's C5I equipment. When required, so as not to cause delays in the Light-Off test schedule, suitable temporary support systems and services may be considered acceptable but only after joint concurrence by the SUPERVISOR, PEO IWS Combat Systems Project Engineer (if assigned), and Ship's Commanding Officer.

3.3.1 Industrial work in 3.3 includes but is not limited to hot work, cutting, grinding, deck work (PRC, nonskid, Terrazzo, NOMEX) and spray painting. Repair and installation of electronics equipment, antennas, machinery, equipment, piping systems, gauges, thermometers, meters, operating instructions and warning plates, remote shutdown devices, strainer shields, valves and hand wheels, access door and scuttles, ventilation systems, lighting systems, electric cables and runs, alarm systems, ground straps, flex hose, resilient mounts, safety devices, interior communication systems, tachometers, and resiliently mounted pipe hangers must be completed. Newly installed or repaired gauges, thermometers, and meters must be calibrated. Access routes need not be released but must be passable or alternate routes made available at all times. Services, either ship or shore based, must be available on a reliable basis. These services are dependent on ship class and include, but are not limited to, 60HZ/400HZ, Air Conditioning (AC), Chilled Water (CW), Firemain or AEGIS Salt Water Cooling pumps, Ventilation, Electronic Cooling Water (ECW) (demineralized water), Dry Air, High Pressure Air (HP), Low Pressure Air (LP), Fwd and Aft SPY skids (AEGIS only), Sonar skid, AN/SPS 49 skid, Command and Decision (C&D) skid (AEGIS only), AN/SLQ 32 Cooling Unit and CIWS heat exchanger. In addition, the Electric Plant Control Equipment (EPCE) console or remote 400HZ console must be available. Cabling from 60HZ Power panels, Chilled Water (CW) hoses (if CHW cooled) and routes must be intact to 400HZ converters. ECW modifications must be completed and all contractor flushes accomplished. If the ship is in dock, and installed equipment or systems (i.e. AC plants, Cooling Skids, Fire-main) must be placed in operation to support C5ILO, then acceptable means to contain overboard discharge(s) must be installed, when directed by the Supervisor.

3.3.2 When in the best interests of the test program, the SUPERVISOR may waive the requirement for final decking installation as part of the initial compartment release. In these cases, install/remove temporary decking to allow safe use of the space will be installed, and final decking installation will occur at a time that does not impede the test program, as authorized by the SUPERVISOR.

3.3.3 C5I testing must not begin in a compartment which has not been formally released per the joint inspection process in 3.2.3. When discrepancies prevent final compartment release, the SUPERVISOR, PEO IWS Combat Systems Project Engineer (if assigned), and Ship's Commanding Officer will determine if industrial work is completed to the degree allowing for the safe and uninterrupted operation and testing of the ship's C5I Systems and Combat Systems Support Equipment.

#### 4. NOTES:

4.1 C5ILO is an availability Key Event scheduled to allow the start of a comprehensive testing and operation of the ships C5I equipment. C5ILO marks the Project Team's and Combat Systems Project Engineer's (if assigned) transition from industrial production work to testing and installation of alterations not able to be performed coincident with industrial work. If discrepancies which preclude uninterrupted testing are identified prior to C5ILO, those discrepancies must be corrected prior to the C5ILO Key Event being declared met.

4.2 The PEO IWS designated representative (if assigned) will provide all CRS documentation, including a list of spaces and systems/equipment along with required completion dates to the SUPERVISOR at A-240 for use in planning and contract award.

NAVSEA  
STANDARD ITEM

FY-24

ITEM NO: 009-118  
DATE: 25 OCT 2022  
CATEGORY: I

1. SCOPE:

1.1 Title: CG Deck Loading; accomplish

2. REFERENCES:

2.1 671-8416047, CG47 Class Topside Laydown Areas & Load Limits

3. REQUIREMENTS:

3.1 Accomplish the requirements of 2.1 for topside deck loading of contractor equipment and supplies.

3.1.1 Submit one legible drawing or sketch of a proposed deck loading plan to the SUPERVISOR for review and acceptance 3 days prior to the start of the availability.

3.1.1.1 Submit updated or changed plans to the SUPERVISOR as they occur.

4. NOTES:

4.1 None.

NAVSEA  
STANDARD ITEM

FY-24

ITEM NO: 009-120

DATE: 25 OCT 2022

CATEGORY: I

1. SCOPE:

1.1 Title: Fact Finding and Critique of Unplanned Event; manage

2. REFERENCES:

2.1 Standard Items

3. REQUIREMENTS:

3.1 Accomplish each fact finding and each critique of a severity Level One event and the requirements of this Standard Item upon discovery of an unplanned event as directed by the SUPERVISOR.

3.1.1 Stop work and ensure immediate actions are taken to mitigate the impact of the unplanned event, reduce or confine the area of concern, and place the work site in a safe and stable condition.

3.1.2 Initiate a preliminary investigation to identify and capture relevant facts regarding the unplanned event. Provide ongoing updates to the SUPERVISOR on immediate actions being taken and the status of the preliminary investigation. Complete the preliminary investigation and submit Attachment E to the SUPERVISOR within 24 hours of receiving direction to initiate actions under this Standard Item.

3.1.2.1. The Preliminary Investigation must contain at a minimum a summary of the relevant facts, chronology of events, actions and results of those actions, damage estimations, where it occurred, who was present and who took action, and any additional circumstances of the event. There should be enough detail to give an overview of the event, to establish the severity level, and allow for the determination of follow on actions. Document the preliminary investigation using Attachment E.

3.1.3 Determine the severity level of problems associated with the unplanned event using Attachment A (Severity Classification Guide).

3.1.4 Obtain SUPERVISOR concurrence that adequate immediate corrective actions have been taken. Resume work only when authorized by the SUPERVISOR.

3.1.5 When directed by the SUPERVISOR, proceed with the Fact Finding Investigation and, if directed, conduct a Critique Meeting.

3.2 Assign a Fact Finding Investigator/Critique Chairperson (See 4.1.3, 4.1.4 and 4.1.5)

3.2.1 Accomplish initial Fact Finding Investigation and prepare a Preliminary Fact Finding Report using Attachment B, Fact Finding Report and Preparation Requirements. Submit a copy of the Preliminary Fact Finding Report to the SUPERVISOR within 3 days of being directed by the SUPERVISOR to proceed in accordance with 3.1.5 or 4 hours prior to the scheduled Critique Meeting, whichever occurs first. Request for additional time must be submitted to and approved by the SUPERVISOR. The Preliminary Fact Finding Report must contain a complete chronological statement of the facts relative to the occurrences leading up to and through the unplanned event, the immediate corrective actions taken, a working copy of Cause and Corrective Action Form to be refined during the Critique Meeting and any other documents used during the fact finding investigation. Include only facts such as what happened, when, where, who was present, who took action, etc.

3.2.2 Obtain written independent statements from all witnesses to the unplanned event to establish the relevant facts.

3.2.3 Compile and review all appropriate references, technical work documents, or other information pertinent to the problem.

3.2.4 Review similar unplanned events from the previous 3 years and corrective actions previously documented to identify repeat problems and the effectiveness of those previous corrective actions.

3.2.5 Coordinate the time and location of the Critique Meeting with the SUPERVISOR and meeting members. Ensure appropriate personnel (including Ship's Force) are notified of the time, location and subject of the Critique Meeting.

3.2.5.1 A Critique Meeting may be deemed not warranted based on the results of the Fact Finding investigation. The problem(s) resulting in the unplanned event must be fully understood and cause(s) clearly known. The SUPERVISOR must concur in the decision to not hold a Critique Meeting and a Final Fact Finding Report must still be prepared and submitted.

3.2.6 Obtain a unique Fact Finding Report Serial Number from the SUPERVISOR. This number must be used as the serial number for the Fact Finding Report and all related documents.

3.3 Conduct Critique Meeting within 3 days of being directed by the SUPERVISOR to conduct a critique.

3.3.1 Commencement of the Critique Meeting may be extended with SUPERVISOR authorization.



3.3.2 Introduce all meeting members at the commencement of the Critique Meeting. Document all attendees using Attachment C, the Critique Meeting Attendance Sheet.

3.3.3 Ensure all pertinent documentation is available and distributed at the Critique Meeting (e.g. Fact Finding Report, appropriate references, technical work documents, chronological statement of relative facts, other information relevant to the problem and a list of any similar problems and corrective actions previously documented).

3.3.4 Brief all attendees that the purpose of the meeting is to encourage open discussion of the relevant facts and problems associated with an unplanned event, so that apparent causes of the problems and effective solutions can be determined. Critique Meetings are not examinations or investigations for the purpose of disciplinary action. Any disciplinary action investigation will be conducted separately and independently of this critique process.

3.3.5 Review all pertinent documentation and open the floor for discussion to determine any additional relevant facts. Obtain agreement/consensus on the relevant facts from all attending personnel.

3.3.6 Update the chronological statement of relevant facts to reflect additional pertinent information discovered during the Critique Meeting.

3.3.7 Document each problem identified during the Critique Meeting on a Cause and Corrective Action form(s), Attachment D.

3.3.8 Coordinate with the SUPERVISOR to assign actions for each problem to the appropriate contractor or designated representative of an organization.

3.3.8.1 More than one action may be required for each problem. All corrective actions must have an actual or estimated completion date. The terms “continuing” or “continuous” are not acceptable. If an action is of a repetitive or continuous nature, the completion date will match the date the policy for that action was disseminated.

3.3.8.2 Ensure the contractor or designated representative of the organization assigned an action item signs the Fact Finding Report Form, Attachment B, acknowledging concurrence.

3.3.8.3 Ensure a Cause and Corrective Action (CCA) form, Attachment D, has been issued to the appropriate organization for follow-up and action.

3.3.8.4 Changes to the Fact Finding Report after the Critique Meeting was adjourned or after the fact finding report has been accepted/signed by the SUPERVISOR, will only be made by the Chairperson with SUPERVISOR concurrence.

3.3.9 Submit one legible copy, in hard copy or approved transferrable media, of the Critique paperwork and associated reports to the SUPERVISOR within 3 days after conclusion of the Critique Meeting.

3.3.10 Track all corrective actions assigned in the Final Fact Finding Report to completion. Ensure the organization assigned actions from the Critique Meeting/Fact Finding provides documentation of completion using the Cause and Corrective Action Form, Attachment D, for all actions taken or in progress within 3 days of assignment and as required thereafter.

3.3.10.1 Notify the SUPERVISOR of any new problems related to the unplanned event that are discovered while working action items.

3.4 Submit one legible copy, in hard copy or approved transferable media, of the Final Fact Finding Report listing the results of the investigation, along with all associated paperwork, to the SUPERVISOR within 30 days of being directed to investigate the Unplanned Event.

3.4.1 Plan for 2 each Fact Finding and one each Critique for a Chief of Naval Operations (CNO) Availability or one each Fact finding and one each critique for a Continuous Maintenance Availability (CMAV).

3.4.1.1 Plan for 12 mandays of labor and 250 dollars of material to accomplish each Fact Finding of an Unplanned Event. If the total costs are less than the authorized manday and dollar amounts, remaining funds will be subject to recoupment. The contractor is not authorized to exceed these limits.

3.4.1.2 Plan for 8 mandays of labor and 250 dollars of material to accomplish each Critique of an Unplanned Event. If the total costs are less than the authorized manday and dollar amounts, remaining funds will be subject to recoupment. The contractor is not authorized to exceed these limits.

3.5 Maintain a record of all Fact Finding and Critique process documents for a minimum of 4 years.

3.5.1 Stored records must be used to conduct trend analysis for any similar problems and corrective actions previously documented to identify repeat problems and to evaluate the effectiveness of those corrective actions.

#### 4. NOTES:

##### 4.1 Definitions.

4.1.1 Apparent Cause: The most likely reason for a problem to have occurred based on a review of relevant facts determined during the preliminary investigation, subsequent investigations and the critique. There may be more than one apparent cause for a problem. The

determination of an apparent cause for a significant problem provides added assurance that the corrective and preventive actions taken must minimize the potential for the problem to reoccur.

4.1.2 Critique: A formal meeting to review a critical or major unplanned event (as defined in Attachment A, Severity Level Classification Guide) to determine the relevant facts, to provide an accurate and documented chronology of the relevant occurrences surrounding the event (before, during and after), to determine the apparent causes of problems and their severity levels, and to validate the adequacy of the immediate corrective actions taken. Apparent cause(s) and corrective and preventive action(s) for each problem should be determined during the critique. Participants will include personnel directly involved with or knowledgeable about the incident, system, or work processes and a cross-section of senior level management.

4.1.3 Critique Chairperson: Appointed by the contractor and responsible for ensuring that the problems associated with unplanned events are properly identified, characterized by severity level, investigated, critiqued (if necessary), have adequate short and long-term corrective actions identified, and are reported in a timely manner. Collects the Cause and Corrective Action (CCA) memos for each problem identified in the critique meeting, reviews them for adequacy, prepares the final Fact Finding Report and obtains the concurrence of the SUPERVISOR with the final Fact Finding Report.

4.1.4 Fact Finding Investigation: An analysis of the unplanned event to corroborate the chronology of events and relevant facts, determine the effectiveness of the immediate corrective actions, identify apparent causes, and who was responsible. Additional corrective and preventive actions may be identified and subsequently implemented during the investigation. An investigation is not as in-depth as a Critique, and therefore does not require a formal meeting or the degree of personnel involvement as the Critique.

4.1.5 Fact Finding Investigator: Appointed by the contractor to conduct Investigation of an unplanned event to determine the relevant facts, chronology, and circumstances of the event and to determine if the event warrants conducting a critique meeting. Provides results of the investigation to the Critique Chairperson.

4.1.6 Fact Finding Report Serial Number: Each unplanned event to be investigated is assigned a unique serial number used for accountability and tracking. Serial Numbers will be provided by the SUPERVISOR.

4.1.7 Immediate Corrective Action: Action(s) taken immediately upon discovery of an unplanned event to put the component or system in a safe condition and correct any problems requiring immediate attention so that it does not escalate into a greater problem.

4.1.8 Short-Term Corrective Action: Actions taken for an unplanned event to collect or mitigate a component or system to a safe condition. Such actions minimize the probability or problem reoccurrence and allow work to continue until long term corrective actions are taken.

4.1.9 Long-Term Corrective Action: Actions taken for an unplanned event to restore a component or system to its original condition or better before the unplanned event. This may also include changes in procedures, additional training or supervision.

4.1.10 Preliminary Investigation: An investigation performed immediately after the occurrence of an unplanned event to quickly determine the relevant facts, chronology, who is responsible and circumstances of the event, to determine the severity level and whether the event warrants conducting a Critique or issuing a Trouble Report.

4.1.11 Unplanned Event: An unexpected occurrence that is not normal behavior or anticipated condition for the process.

4.1.12 Fires are unintended states, processes, or instances of combustion in which fuel or other material is ignited and combined with oxygen, giving off smoke, sparks, or flame. Smoke or sparks may or may not be present. However, if unexpected smoke or sparks exist, a fire should be assumed to exist (this is especially relevant to Class 'C' fires when the smoke or sparks cease after power is secured).

4.2 Problems identified to Ship's Force will only require a response for immediate and short-term corrective action. Long-term corrective actions will be taken through the established processes within the command. Systemic problem areas identified may be addressed through other administrative reporting procedures with cognizant Immediate Superior in Command (ISIC) personnel.

4.3 If problems are identified to contractors working for AIT managers, the Alteration Installation Team (AIT) managers are required to initiate and conduct the Fact Finding process for unplanned events. The SUPERVISOR must participate as necessary to ensure effectiveness.

4.4 Each Crane accident occurring on US Naval installations will be reported and investigated in accordance with 009-40 of 2.1 unless otherwise directed by the SUPERVISOR.

4.5 Initial submission of Attachment A under 009-74 of 2.1 may be substituted for Attachment E under this Standard Item. Duplicate submission of Attachment E is not required.

## ATTACHMENT A

### SEVERITY LEVEL CLASSIFICATION GUIDE

#### 1. PROBLEM SEVERITY LEVELS:

1.1 Problems associated with unplanned events shall be assigned one of 3 levels of severity (Level One, 2, or 3) to distinguish those problems that have the most impact on an activity in accomplishing its mission. Severity levels also help ensure appropriate resources are focused on the most significant problems.

1.2 For each unplanned event identified, attempt to determine the level of severity of the problem(s) during the preliminary investigation.

1.2.1 Problems meeting the criteria of Levels One normally require both a Fact Finding Investigation and a Critique Meeting to determine and correct the cause(s) of the unplanned event.

1.2.2 Problems meeting the criteria of Level 2 or 3 shall be investigated to determine and correct the cause(s) of the unplanned event, normally on the spot, but a Fact Finding Report is not required for a Level 2 or 3 problem. For completeness, Level 2 or 3 problems identified in conjunction with a Fact Finding Investigation for a Level One problem shall be included in the Fact Finding Report.

1.3 The severity level for each problem shall be determined using the following guidelines:

##### 1.3.1 Level One “CRITICAL”

1.3.1.1 A problem or trend which has or could result in significant rework, significant environmental hazard, radiological incident, equipment malfunctions, nuclear violations, serious personnel injury or renders safeguards ineffective. A Level One deficiency often results in significant recovery time and cost. Level One problems normally require Technical Authority and/or senior management attention to resolve.

1.3.1.2 Level One deficiencies often result in significant recovery time/cost. A series or trend of Level 2 deficiencies should be grouped together and identified as Level One.

Examples of Level One problems include:

- Equipment damage greater than \$50K
- Any rework costing over \$100K
- Breakdown in Work Control/Tag Out processes leading to personnel injury or equipment damage

- Crane accident resulting in an event such as derailment, overload, injury to personnel, dropped material, equipment damage, unplanned contact between the load, crane or object
- Serious personnel injury (e.g., chemical burn, electric shock, fall)
- Flammable liquid spill
- A shipboard or facility fire that cannot be (or was not) controlled by a Firewatch and requires Ship's Force in port Emergency Response and/or Fire Department assistance to extinguish
- Broken weight handling equipment (while in use)
- Personnel in a toxic environment without proper gas free certification (space not gas free)

### 1.3.2 Level 2 "MAJOR"

1.3.2.1 A problem or trend which, if not identified and corrected, has the potential to result in a Level One problem or which results in equipment degradation requiring DFS approval. Level 2 problems may require Technical Authority involvement and senior management attention.

1.3.2.2 A series or trend of Level 3 deficiencies should be grouped together and identified as Level 2.

Examples of Level 2 problems include:

- Equipment damage of less than \$50K
- Using improper test procedures
- Loss of cleanliness of a system or equipment
- Component identified out of position (i.e. valve or switch open in lieu of shut)
- Systemic problems regarding safety requirements
- Personnel in a toxic environment without gas free certification properly posted (not posted but space was Gas Free)
- Not following written procedures (e.g., Process Control Procedures, Test Plan)
- Safety discrepancies that pose an immediate threat or danger
  - Minor shipboard or facility fire that can be extinguished with handheld fire extinguisher or hose by a Firewatch. (NOTE: If a Firewatch or hot worker extinguishes minor sparks or flames as part of the hot work process, then it is a Level 3 event.)
  - Breakdown in Work Control Tag Out processes not leading to personnel injury or equipment damage.

### 1.3.3 Level 3 "MINOR"

1.3.3.1 Isolated deficiencies with minimal overall impact and no significant consequences. Level 3 problems are normally corrected on the spot (i.e. document the deficiency and brief personnel involved) with an immediate corrective action.

Examples of Level 3 problems include:

- Any problem not categorized as Level One or Level 2
- Required notification of the problem was not made in a timely manner
- Paint sample taken at incorrect location
- Required procedures not on site
- OQE or reports not recorded or submitted in required time
- Unsafe work practices
- Poor craftsmanship
- Repeated housekeeping violations

Attachment B  
FACT FINDING REPORT AND PREPARATION REQUIREMENTS

\*Note: Mark the security classification on the report as applicable based on the sensitivity of the information contained in the report.

1. Preliminary Fact Finding Report:

1.1 An in-progress report that shall consist of the following:

1.1.1 Fact Finding Report Form filled out with the “Preliminary Report” box checked.

1.1.2 Chronological statement of relevant facts.

1.1.3 Working copy of cause and Corrective Action Forms(s) Attachment (D)

1.1.4 Any other document(s) used during the Fact Finding Investigation.

2. Final Fact Finding Report:

2.1 A final Fact Finding Report shall consist of the following:

2.1.1 Completed Fact Finding Report Form with the “Final Report” box checked and senior manager review.

2.1.2 Complete chronological statement of relevant facts from the unplanned event.

2.1.3 Completed Cause and Corrective Action Form(s) (Attachment D)

2.1.4 Any other document(s) used during the Fact Finding Investigation (e.g. Independent statements from individual(s), appropriate references, technical work documents).

2.1.5 Critique Meeting attendance form (Attachment C), if a Critique Meeting was held.

2.1.6 Identify any similar Unplanned Event(s).



FACT FINDING REPORT FORM

Preliminary Report

UNCLAS

Final Report

NOFORN

SENIOR MANAGER REVIEW: \_\_\_\_\_

CONFIDENTIAL

ACTIVITY RESPONSIBLE FOR INVESTIGATION OF UNPLANNED EVENT:

\_\_\_\_\_  
\_\_\_\_\_

CRITIQUE DATE/TIME (indicate "report only" if no critique held): \_\_\_\_\_

REPORT SERIAL NUMBER: \_\_\_\_\_ DATE REPORT ISSUED: \_\_\_\_\_

DATE/TIME OF ACTUAL UNPLANNED EVENT: \_\_\_\_\_

DATE/TIME WHEN UNPLANNED EVENT WAS DISCOVERED:

\_\_\_\_\_

LOCATION OF UNPLANNED EVENT (i.e. building/facility, room/space): \_\_\_\_\_

\_\_\_\_\_

TITLE (based on the most obvious problem): \_\_\_\_\_

\_\_\_\_\_

SEVERITY LEVEL ASSIGNED: \_\_\_\_\_

DESCRIPTION OF THE UNPLANNED EVENT: \_\_\_\_\_

\_\_\_\_\_

IMMEDIATE CORRECTIVE ACTIONS TAKEN: \_\_\_\_\_

\_\_\_\_\_

PREVIOUS SIMILAR UNPLANNED EVENT(S): YES  NO  IF YES, LIST SERIAL NUMBER(S) \_\_\_\_\_

PROCEDURE NUMBER: \_\_\_\_\_ STEP BEING WORKED: \_\_\_\_\_

DISCOVERED BY: \_\_\_\_\_ PHONE #: \_\_\_\_\_

CHAIRPERSON: \_\_\_\_\_ PHONE #: \_\_\_\_\_

FACT FINDING REPORT FORM (Cont.)

ORGANIZATION(S) RESPONSIBLE FOR IDENTIFIED PROBLEMS OR ASSIGNED ACTIONS/OPEN ITEMS

ORG: \_\_\_\_\_ ORG: \_\_\_\_\_ ORG: \_\_\_\_\_ ORG: \_\_\_\_\_ ORG: \_\_\_\_\_ ORG: \_\_\_\_\_

CONCURRENCE SIGNATURES

CHAIRPERSON/DATE: _____	SUPERVISOR/DATE: _____
CONCURRENCE BY/DATE: _____	CONCURRENCE BY/DATE: _____
CONCURRENCE BY/DATE: _____	CONCURRENCE BY/DATE: _____
CONCURRENCE BY/DATE: _____	CONCURRENCE BY/DATE: _____
CONCURRENCE BY/DATE: _____	CONCURRENCE BY/DATE: _____
CONCURRENCE BY/DATE: _____	CONCURRENCE BY/DATE: _____



ATTACHMENT D  
CAUSE AND CORRECTIVE ACTION FORM

REPORT SERIAL NUMBER: \_\_\_\_\_ EVENT SEVERITY LEVEL: \_\_\_\_\_

MANAGER/TECHNICAL CODE: \_\_\_\_\_ DATE ISSUED: \_\_\_\_\_

1. This form contains the problem descriptions that were identified as being partially or wholly the responsibility of \_\_\_\_\_. As the \_\_\_\_\_ manager, you are responsible to follow up and take the appropriate actions to correct the listed problems.

PROBLEM # \_\_\_\_\_ PROBLEM SEVERITY LEVEL \_\_\_\_\_

DESCRIPTION: \_\_\_\_\_  
\_\_\_\_\_  
\_\_\_\_\_

CAUSE: \_\_\_\_\_  
\_\_\_\_\_  
\_\_\_\_\_

SHORT-TERM CORRECTIVE ACTIONS: \_\_\_\_\_  
\_\_\_\_\_  
\_\_\_\_\_

ESTIMATED COMPLETION DATE: \_\_\_\_\_ ACTUAL COMPLETION DATE: \_\_\_\_\_

LONG-TERM CORRECTIVE ACTIONS: \_\_\_\_\_  
\_\_\_\_\_  
\_\_\_\_\_

ESTIMATED COMPLETION DATE: \_\_\_\_\_ ACTUAL COMPLETION DATE: \_\_\_\_\_

ACTION ASSIGNMENT SIGNATURES

CRITIQUE CHAIRPERSON \_\_\_\_\_ DATE: \_\_\_\_\_  
(prime contractor)

SUPERVISOR REPRESENTATIVE: \_\_\_\_\_ DATE: \_\_\_\_\_

RESPONSIBLE ORGANIZATION: \_\_\_\_\_ DATE: \_\_\_\_\_

ACTION COMPLETION/ACCEPTANCE SIGNATURES

RESPONSIBLE ORGANIZATION: \_\_\_\_\_ DATE: \_\_\_\_\_

PRIME CONTRACTOR ACCEPTANCE: \_\_\_\_\_ DATE: \_\_\_\_\_

SUPERVISOR REPRESENTATIVE: \_\_\_\_\_ DATE: \_\_\_\_\_

Attachment E

<b>PRELIMINARY INVESTIGATION</b>			
Proposed Severity Level	<input type="checkbox"/> Level 1	<input type="checkbox"/> Level 2	<input type="checkbox"/> Level 3

<u>SHIP:</u>  <u>DATE:</u>  <u>TIME:</u>	<u>COMPANY:</u>  <u>SUB-CONTRACTOR(s):</u>
<u>LOCATION OF EVENT:</u>	<u>INJURIES:</u>
<u>APPARENT CAUSE:</u>	<u>EQUIPMENT DAMAGE:</u>
<u>WORK ITEM NUMBER:</u>	<u>CONTRACT NUMBER:</u>

**WITNESS AND/OR INDIVIDUALS INVOLVED**

NAME(S)	DEPT.	COMPANY

**SUMMARY OF EVENT**

**IMMEDIATE CORRECTIVE ACTION(include who performed the action)**

<b>INVESTIGATED BY (PRINT NAME):</b>	<b>TITLE/PHONE NUMBER:</b>
--------------------------------------	----------------------------

NAVSEA  
STANDARD ITEM

FY-24

ITEM NO: 009-121  
DATE: 25 OCT 2022  
CATEGORY: II

1. SCOPE:

1.1 Title: Ship Assessment/Inspection; accomplish

2. REFERENCES:

2.1 None.

3. REQUIREMENTS:

3.1 Provide the services of qualified on-site technical representatives and resources to accomplish Ship Assessments/Inspections.

3.1.1 Provide Assessors that meet all qualification requirements for each specific Assessment/Inspection area assigned and the following general qualification requirements.

3.1.1.1 Have technical knowledge of the specified equipment or process, and have a documented history of conducting Material Assessments/Inspections on similar equipment or processes.

3.1.1.2 Have demonstrated competence with required Standard Work Templates (SWT) and procedures specified in the Class Maintenance Plan (CMP) and the Planned Maintenance system (PMS) database.

3.1.1.3 Have demonstrated competence with submitting technically accurate documentation of both satisfactory and unsatisfactory Assessment/Inspection results (OPNAV 4790 2-Kilo's and Automated Work Requests).

3.1.2 Comply with the following requirements when conducting Assessments/Inspections and reporting deficient material conditions of assigned ships equipment/systems.

3.1.2.1 Integrate work requirements, setting of priorities, coordinating with the ship, and de-conflicting of other ship Assessments/Inspections as agreeable by the SUPERVISOR.

3.1.2.2 Conduct Assessments/Inspections only using tasks from the Class Maintenance Plan (CMP) or Assessment Procedures (AP) Maintenance Requirement Cards

(MRC) in the Planned Maintenance System (PMS) database.

3.1.2.3 Verify all established procedures (e.g., CMP, MRC) are reviewed for technical accuracy and ability to comply with the procedure as written.

3.1.2.4 Inform the SUPERVISOR of any deficiencies or technical inaccuracies in the Assessment/Inspection procedures.

3.1.2.5 Submit Technical Feedback Report (TFBR) to the SUPERVISOR to address any deficiencies or technical inaccuracies in the Assessment/Inspection procedure. Ensure TFBR describes what is required to properly perform Assessment/Inspection.

3.1.3 Document all Assessment/Inspection findings, whether satisfactory or unsatisfactory using an OPNAV 4790 2-Kilo or Automated Work Request (AWR).

3.1.3.1 The SUPERVISOR is the ultimate approval authority for review of 2-Kilo's and AWR's written during an Assessment/Inspection. Any corrections identified as necessary due to error or omission by the contractor must be promptly corrected by the contractor.

4. NOTES:

4.1 None.



NAVSEA  
STANDARD ITEM

FY-24

ITEM NO: 009-122  
DATE: 25 OCT 2022  
CATEGORY: I

1. SCOPE:

1.1 Title: Temporary Padeye; install and remove

2. REFERENCES:

2.1 Standard Items

2.2 804-5184133, Padeye, Machinery Lifting

2.3 MIL-STD-1689, Fabrication, Welding, and Inspection of Ships Structure

2.4 ASME BTH-1-2017. Design of Below-the-Hook Lifting Devices

2.5 S0600-AA-PRO-160, Underwater Ships Husbandry Manual

3. REQUIREMENTS:

3.1 Design and fabricate each temporary padeye and rigging attachment in accordance with 2.2 through 2.4.

3.1.1 Except as specified in 3.1.1.1, each temporary padeye for weight handling on surface ship and non-nuclear loads must be designed in accordance with 2.2 and 2.4.

3.1.1.1 Configuration and safety factors for temporary padeyes used solely in the handling and attachment of cofferdams or other underwater fixtures must meet the requirements of 2.5.

3.1.2 Submit one legible copy, in hard copy or approved transferrable media, of a report listing the design of each planned temporary padeye not in compliance with 2.2 and 2.4 SUPERVISOR approval 7 days prior to planned installation. Include material specification, dimensional drawing(s), weld joint design, intended use, and installation location.

3.2 Install and inspect each temporary padeye in accordance with 2.2 through 2.4.

3.2.1 Inspect each temporary padeye and support structure for cracks and deformation prior to installation.

3.2.1.1 Submit one legible copy, in hard copy or approved transferrable media, of a report listing results of the requirements of 3.2 and 3.2.1 to the SUPERVISOR.

3.2.2 Accomplish the requirements of 009-12 of 2.1, including Table 2, Columns A, B, or C, lines one through 7.

3.2.3 Maintain a log of each temporary padeye installed to include a unique serial number, Safe Working Load, location by Compartment and approximate frame, date installed and date removed.

(I) "NON-DESTRUCTIVE TESTING"

3.3 Accomplish a NDT of each temporary padeye, attachment weld, and attachment point to ship's structure for deformation, elongation, and cracking. Allowable Defects: None.

3.3.1 For steel temporary padeyes with a Safe Working Load (SWL) over 2,000 pounds accomplish VT and MT in accordance with 2.3.

3.3.2 For steel temporary padeyes with a SWL 2,000 pounds and less accomplish VT in accordance with 2.3.

3.3.3 For aluminum temporary padeyes with a SWL over 1,500 pounds accomplish VT and PT in accordance with 2.3.

3.3.4 For aluminum temporary padeyes with a SWL 1,500 pounds and less accomplish VT in accordance with 2.3.

3.4 Upon completion of satisfactory testing and inspection, label each temporary padeye with paint, paint stick or other permanent marking. Include the padeye serial number, "T" for Temporary, and Safe Working Load (Example: NNN T SWL "2,000" pounds).

(I) NON-DESTRUCTIVE TESTING

3.5 Chip and grind surfaces in way of removals each temporary padeye at the conclusion of the work for which they were installed. Removal must be in accordance with Section 14.10 of 2.3

3.5.1 Inspect each removal site in accordance with the requirements of 009-12 of 2.1, including Table 2 Columns A, B, or C, lines 6, 7, 10, and 11, in accordance with reference 2.3.

3.5.1.1 Accomplish MT inspection in accordance with 009-12 of 2.1, including Table 2, Column B, line 11 for all temporary padeye removals from HY-80/100 and HSLA 100/115 primary structure (CVN only).

3.5.2 Accomplish the welded repair requirements of 009-12 of 2.1, including Table 2, Column A, B, or C, lines One through 11 in accordance with reference 2.3.

3.6 Accomplish the requirements of 009-32 of 2.1 for each new and disturbed surface.

3.7 Submit one legible copy, in hard copy or approved transferrable media, of completed log of 3.2.3 to the SUPERVISOR within 72 hours after removing all temporary padeyes, or prior to ship's departure, whichever occurs first.

#### 4. NOTES:

4.1 Weight handling padeyes or devices which are proof-tested to 200 percent of their SWL with a post-test visual inspection in accordance with paragraph 3.3 do not require inspection of welds by penetrant or magnetic methods unless otherwise specified.

NAVSEA  
STANDARD ITEM

FY-24

ITEM NO: 009-123  
DATE: 25 OCT 2022  
CATEGORY: II

1. SCOPE:

1.1 Title: Fiber Optic Component; inspect, install, repair, remove, and test

2. REFERENCES:

2.1 Standard Items

2.2 MIL-STD-1678, Fiber Optic Cabling Systems Requirements and Measurements

2.3 MIL-STD-2042, Fiber Optic Cable Topology Installation Standard Methods for Surface Ships and Submarines

2.4 MIL-STD-2003, Electric Plant Installation Standards for Surface Ships and Submarines

2.5 IA PUB-5239/31, Information Assurance Shipboard Red/Black Installation Publication

2.6 CNSSAM TEMPEST/01-13, (U) RED/BLACK Installation Guidance

2.7 SE000-01-IMB-010, Navy Installation and Maintenance Book (NIMB), Section IX, Installation Standards (Source CD: N00024000033)

2.8 S9086-PF-STM-010/CH-408; Fiber Optic Cable Topology

2.9 S9AA0-AB-GOS-010, General Specifications for Overhaul of Surface Ships (GSO)

3. REQUIREMENTS:

3.1 Ensure employees accomplishing work (e.g., installer, QA oversight, direct supervision) on fiber optic systems have accomplished Navy Shipboard fiber optic training and achieved certification in accordance with requirement 1306 of Part 1 of 2.2.

3.1.1 Maintain current certification for each employee working on fiber optic systems. Employees must present certification card when requested by the SUPERVISOR.

3.1.2 Submit one legible copy, in hard copy or approved transferrable media, of a report listing all personnel involved in accomplishing fiber optic installation or repair (e.g., installers, QA oversight, direct supervision) to the SUPERVISOR prior to the start or continuation of production work. Submit any changes as they occur.

3.2 Inspect existing affected cable installations and interferences within the first 25 percent of contract completion. Inspect each fiber optic cable (conventional and Blown Optical Fiber (BOF)) in accordance with Method 6A1 of 2.3.

3.2.1 Submit one legible copy, in hard copy or approved transferrable media, of a report listing results of the requirements of 3.2 including cable installation conditions not in compliance with 2.3 and 2.6 to the SUPERVISOR within 4 days of completion of inspections.

3.2.1.1 Report shall state if cable installation inspections resulted in no compliance issues.

3.3 Accomplish fiber optic installations in accordance with 2.3.

3.3.1 Install each new Fiber Optic Interconnection Box (FOICB), Tube Routing Box (TRB), patch panel, fusion splice tray holder, cable, cableway, and penetration, including those to be protected from the weather, in accordance with 2.3.

3.3.2 Install saddles on BOF cabling to prevent crushing the BOF tubes when tightening cableway bands in accordance with 2.3.

3.3.3 Use existing ship cableway and penetrations wherever possible. Penetrations must be correct size in accordance with 2.3 and 2.4.

3.3.3.1 Accomplishment of a cableway inspection for each modified cableway and penetration must be in accordance with NAVSEA Standard Items (See Note 4.7).

3.3.4 Install each fiber optic cable and components which are part of a secure information processing system or are located within a secure processing space in accordance with 2.5 and 2.6.

3.3.5 Install each new fiber optic connector of the correct size and type conforming to MIL-DTL-83522, MIL-PRF-28876, or MIL-PRF-64266 in accordance with Part 5 of 2.3.

3.3.5.1 Ensure each fiber optic connector is not exposed to the industrial environment or weather.

3.3.5.2 Accomplish inspection and cleaning of both fiber optic connectors prior to mating in accordance with Method 6M1 of 2.3.

3.3.6 Accomplish the optical link loss test in accordance with Method 6C1 or Method 6C2 of 2.3 upon the completion of connector attachment, slack management, banding, and penetration closeout for each fiber optic cable.

3.3.7 Accomplish the optical continuity test in accordance with Method 6D1 of 2.3 for cables with fibers that are not terminated on each end.

3.3.8 Accomplish the optical return loss test in accordance with Method 6K1 of 2.3 for single mode fiber links upon the completion of connector attachment, slack management, banding, and penetration closeout for fiber optic cables.

3.3.9 Accomplish the tube seal verification test in accordance with Method 6J1 of 2.3 for BOF cables after installation of connectors, when required per 5.3.2 of 2.3, and for unused BOF tubes within BOF cables. Accomplish the ball bearing test in accordance with Method 6H1 of 2.3 for unused BOF tubes within BOF cables.

3.3.10 Accomplish the BOF tube end sealing in accordance with Method 2J1 of 2.3 for all empty BOF tubes in tube routing boxes, fiber optic interconnection boxes, and equipment.

3.3.11 Install new cable identification tags in accordance with Part 4 of 2.3, using 2.7 for guidance. Mark each cable, tube, furcation unit, Optical Fiber Cable Component (OFCC) and connector in accordance with the referenced drawings, equipment technical manual and 2.3.

3.3.12 Accomplish post-installation visual inspection in accordance with Method 6A1 and attenuation test Method 6E1 or Method 6E2 of 2.3. For single mode links, accomplish return loss test in accordance with Method 6L1 of 2.3. Use Method 6A1 to verify no mechanical damage exists to the installed fiber optic cables. Use Methods 6E1 or Method 6E2 and 6L1 to measure the optical loss and return loss (respectively) over a series of concatenated optical links, performed after interconnection of the Fiber Optic Cable Topology (FOCT) local and trunk cables.

3.3.13 Accomplish inspection and cleaning of each new and existing fiber optic connector immediately prior to mating in accordance with Method 6M1 of 2.3.

3.3.14 Install connectorized cables to equipment, using system drawings or other technical documents. Light Duty connectors must only be installed within fiber optic interconnection boxes (FOICBs) or within equipment enclosures/racks. Heavy Duty connectors must be installed externally to equipment enclosures/racks.

3.4 Accomplish fiber optic repair, relocation, and removal in accordance with 2.3 and 2.8.

3.4.1 Install each Fiber Optic Interconnection Box (FOICB), Tube Routing Box (TRB), patch panel, fusion splice tray holder, cable, and fusion splice tray to be repaired and/or relocated in accordance with 2.3.

3.4.2 Use existing cableways and penetrations wherever possible. Penetrations must be the correct size in accordance with 2.3 and 2.4. Penetrations not reused must be blanked in accordance with 2.3 and 2.4.

3.4.3 Accomplish the continuity test in accordance with Method 6D1 of 2.3 for each fiber optic cable prior to repair.

3.4.4 Accomplish inspection and cleaning of each new and existing fiber optic connector immediately prior to mating in accordance with Method 6M1 of 2.3.

3.4.5 Isolate and repair fiber optic cable jacket in accordance with Method 1B1 of 2.3.

3.4.6 Isolate and repair each fiber optic connector in accordance with Part 5 of 2.3.

3.4.7 Ensure fiber optic connectors, cables and boxes are not exposed to the industrial environment or weather in accordance with 2.3.

3.4.8 Identify and isolate each cable to be pulled back, rerouted, reused or repurposed.

3.4.9 Install new cable identification tags in accordance with Part 4 of 2.3, using 2.7 for guidance.

3.4.10 Install new banding for cableways affected by cable removals in accordance with Part 4 of 2.3.

3.4.11 Install saddles on BOF cabling to prevent crushing the BOF tubes when tightening cableway bands in accordance with 2.3.

3.4.12 Accomplish the visual inspection of Method 6A1 for each fiber optic cable (conventional and BOF) in accordance with 2.3 upon the completion of the repair and final banding.

3.4.13 Accomplish the link loss test of Method 6C1 or Method 6C2 for each fiber optic cable (conventional and BOF) in accordance with 2.3 upon the completion of the repair and final banding.

3.4.14 Accomplish the return loss test of Method 6K1 for single mode links only for each fiber optic cable (conventional and BOF) in accordance with 2.3 upon the completion of the repair and final banding.

3.4.15 Accomplish the visual inspection of Method 6A1 and the continuity test of Method 6D1 of 2.3 for repaired cables with fibers that are not terminated on each end.

3.4.16 Accomplish the tube seal verification test of Method 6J1 of 2.3 after installation of connectors, when required per 2.3, and for unused BOF tubes within BOF cables. Accomplish the ball bearing test of Method 6H1 of 2.3 for unused BOF tubes within BOF cables.

3.4.17 Accomplish inspection and cleaning of each new and existing fiber optic connector immediately prior to mating in accordance with Method 6M1 of 2.3.

3.4.18 Connect each cable, using referenced drawing or retained hook-up data.

3.4.19 Identify, isolate, and remove each fiber optic cable designated for removal in its entirety.

3.4.19.1 Blank each bulkhead penetration, deck penetration, and multi-cable transit device from which cable was removed and which will not be reused, in accordance with 2.3 and 2.4.

3.4.19.2 Blank each unused hole in equipment, in accordance with 2.3 and 2.6.

3.4.19.3 Remove unused hangers from which cable was removed and which will not be reused, in accordance with Section 070a of 2.9.

3.4.20 Remove and relocate each fiber optic cable and component which are part of secure information processing systems or are located within a secure processing space in accordance with 2.5 and 2.6.

3.5 Accomplish fiber optic splicing in accordance with the BOF Cable Splice Method 1C1 of 2.3 or the fusion splice installation Method 2K1, Method 2K2 or Method 2K3 of 2.3. Install each fusion splice component (e.g., fusion splice, splice protector, fusion splice tray, fusion splice tray holder module) conforming to MIL-PRF-24623/6 and MIL-PRF-24728/8. Ensure each fusion splicer conforms to Commercial Item Description (CID) A-A-59799.

3.5.1 Accomplish the optical test in accordance with Method 6E1 or Method 6E2 of 2.3 upon the completion of fusion splicing, slack management, banding, and penetration closeout of each fiber optic cable.

3.5.2 Accomplish the return loss test in accordance with Method 6L1 of 2.3 for single mode fiber links only upon the completion of fusion splicing, slack management, banding, and penetration closeout of each fiber optic cable.

3.5.3 Accomplish inspection and cleaning of each new and existing fiber optic connector immediately prior to mating in accordance with Method 6M1 of 2.3.

3.5.4 Verify continuity of each spliced tube with a ball bearing in accordance with Method 6H1 of 2.3.



3.5.5 Accomplish the ball bearing test of Method 6H1 and the tube seal verification test of Method 6J1 of 2.3 for unused BOF tubes within BOF cables.

3.6 Accomplish fiber optic testing in accordance with Part 6 of 2.3.

3.7 Install new banding for cableways affected by cable installs, removals, pulled back, reused, rerouted, and repurposed in accordance with Part 4 of 2.3. Saddles must be used on BOF cabling to prevent crushing the BOF tubes when tightening cableway bands in accordance with 2.3.

3.8 Accomplishment of local air hose tests after the installation, removal and relocation of fiber optic cables of each new and disturbed multi-cable transit device, multi-cable penetrators, stuffing tubes, kick pipes, and cable penetrations of tightness boundaries must be in accordance with NAVSEA Standard items (See Note 4.8).

3.9 Accomplishment of cleaning and painting for new and disturbed surfaces must be in accordance with NAVSEA Standard Items (See Note 4.8).

3.10 Inspect fiber optic installations, repairs, relocations, and removals in accordance with 2.3.

3.11 Submit one legible copy, in hard copy or approved transferrable media, of a report listing results of the requirements of 3.3.1.1, 3.3.6 through 3.3.9, 3.3.12, 3.3.13, 3.4.3, 3.4.4, 3.4.8, 3.4.12 through 3.4.17, 3.5.1 through 3.5.5, and 3.6 to the SUPERVISOR within 3 days after recording the data.

#### 4. NOTES:

4.1 The requirements in this Standard Item apply to installation, repair, removal, relocation, test, and inspection of fiber optic components on Naval surface ships and submarines and personnel supporting these tasks. This Standard Item applies to the following fiber optic cable usages; new, pulled back, reused, rerouted, repurposed, removed and replaced.

4.2 Definitions.

4.2.1 New Cable –a cable not previously installed.

4.2.2 Pulled Back Cable – a cable disconnected and physically removed from a wireway, conduit, or cableway to protect the cable from industrial use.

4.2.3 Reused Cable – a cable disconnected from the equipment to facilitate equipment removal.

4.2.4 Rerouted Cable – a cable disconnected from their equipment and physically moved to a new wireway, conduit or, cableway and then reconnected in the new location to the same equipment.

4.2.5 Repurposed Cable – a cable with termination points changed.

4.2.6 Remove Cable – a cable disconnected from equipment and physically removed in its entirety and not being replaced.

4.2.7 Replaced Cable – a cable disconnected from equipment and physically removed to facilitate replacement with a new cable.

4.3 Cable installations consist of cable, banding, boxes, equipment, penetrations, cableways, cable separation and connection(s) and associated components.

4.4 The formats of Attachment A, B and C are provided as guidance. Other reporting formats can be used with the approval of the SUPERVISOR.

4.5 Navy fiber optic Technical Authority policy letters and drawings, and the list of Certified Navy Shipboard Fiber Optic Trainers (CFOTL) can be located by sending an email to [DLGR\\_NSWC\\_FOWEB@navy.mil](mailto:DLGR_NSWC_FOWEB@navy.mil) with the specific subject line of: website URL request

4.6 The Navy Shipboard Fiber Optic Technical Authority is:  
[DLGR\\_NSWC\\_FO\\_ENG@navy.mil](mailto:DLGR_NSWC_FO_ENG@navy.mil)

4.7 If local air hose test of 3.8 is required, the use of Standard Item 009-25 “Structural Boundary Test; accomplish” of 2.1 will be specified in the Work item.

4.8 If cleaning and painting for new and disturbed surfaces of 3.9 are required, the use of Standard Item 009-32 “Cleaning and Painting Requirements; accomplish” will be specified in the Work Item.

ATTACHMENT A  
OPTICAL MEASUREMENT RECORD (FOR ASSEMBLY LINK LOSS/RETURN LOSS)

DATE \_\_\_\_/\_\_\_\_/\_\_\_\_ HULL NUMBER \_\_\_\_\_  
 ENDPOINT LOCATIONS OR EQUIPMENT NAME: SOURCE \_\_\_\_\_ DETECTOR \_\_\_\_\_  
 INSTALLATION/CONFIGURATION DRAWING \_\_\_\_\_ CABLE SERIAL NUMBER \_\_\_\_\_  
 CABLE TYPE<sup>1</sup> \_\_\_\_\_  
 CABLE VISUAL INSPECTION RESULT (INSTALLATION) \_\_\_\_\_  
 CONNECTOR TYPE(S)<sup>1</sup> \_\_\_\_\_ TEST EQUIPMENT MANUFACTURER/MODEL NO. \_\_\_\_\_  
 SERIAL NO. \_\_\_\_\_ CALIBRATION DUE DATE \_\_\_\_/\_\_\_\_/\_\_\_\_  
 SOURCE WAVELENGTH(S)(NM) \_\_\_\_\_ / \_\_\_\_\_  
 CONNECTOR ENDFACE QUALITY (IAW Part 5 of 2.3) \_\_\_\_\_

SOURCE CABLE NO <sup>2</sup>	DETECTOR CABLE NO <sup>2</sup>	850NM/1300NM/1310NM/1550NM WINDOW (CIRCLE ONE)									
FIBER COLORS <sup>3</sup> OR NUMBER	FIBER COLORS <sup>3</sup> OR NUMBER	ACCEPTABLE ASSEMBLY LINK LOSS (dB) (6C1/6C2)	ACCEPTABLE RETURN LOSS (dB) (6K1)	FORWARD REFERENCE POWER (6C1/6C2)	FORWARD MEASURED POWER (6C1/6C2)	FORWARD ASSEMBLY LINK LOSS RESULT <sup>4</sup> (dB) (6C1/6C2)	FORWARD RETURN LOSS RESULT <sup>5</sup> (dB) (6K1)	REVERSE REFERENCE POWER (6C1/6C2) <sup>6</sup>	REVERSE MEASURED POWER (6C1/6C2) <sup>6</sup>	REVERSE ASSEMBLY LINK LOSS RESULT (dB) <sup>6</sup> (6C1/6C2)	CABLE LENGTH (M) (6C1/6C2)



ATTACHMENT B

BLOWN OPTICAL FIBER (BOF) TEST RECORD

DATE \_\_\_\_/\_\_\_\_/\_\_\_\_ HULL NUMBER \_\_\_\_\_

INSTALLATION/CONFIGURATION DRAWING \_\_\_\_\_ CABLE SERIAL NUMBER \_\_\_\_\_

CABLE TYPE<sup>1</sup> \_\_\_\_\_

CABLE VISUAL INSPECTION RESULT (INSTALLATION/POST-INSTALLATION)

\_\_\_\_\_/\_\_\_\_\_

LOCATION 1	LOCATION 2	EQUIPM ENT 2 IDENTIFI CATION	BOF TRUNK CABLE IDENTIF ICATION	BOF TRUNK TUBE NO.	BALL BEARING (BB) TEST DIRECTION <sup>2</sup> (6H1)	BOF TUBE BB TEST RESUL T <sup>3</sup> (PASS/ FAIL) (6H1)	BB SIZE PASS/ FAIL <sup>4</sup> (6H1)	BOF TUBE LODGED WITH BB (Y/N) (6H1)	BOF TUBE SEAL VERIFICA TION RESULTS <sup>5</sup> (PASS/FAI L) (6J1)	CABLE LENGTH (M)

NOTES:<sup>1</sup>RECORD MIL-SPEC NUMBER IF APPLICABLE. <sup>2</sup>FOR EXAMPLE, TEST DIRECTION = "LOCATION 1 → LOCATION 2" OR VICE VERSA. <sup>3</sup>IAW METHOD 6H1 OF REFERENCE 2.3. <sup>4</sup>FOR EXAMPE, BB SIZE = "4.5 MILLIMETER(MM)". <sup>5</sup>IAW METHOD 6J1 OF REFERENCE 2.3.

REMARKS: \_\_\_\_\_

SIGNATURE: \_\_\_\_\_

ATTACHMENT C

OPTICAL MEASUREMENT RECORD (FOR FOCT END-TO-END ATTENUATION AND RETURN LOSS)

DATE \_\_\_\_/\_\_\_\_/\_\_\_\_ HULL NUMBER \_\_\_\_\_  
 ENDPOINT LOCATIONS OR EQUIPMENT NAME: SOURCE \_\_\_\_\_ DETECTOR \_\_\_\_\_  
 INSTALLATION/CONFIGURATION DRAWING \_\_\_\_\_ CABLE SERIAL NUMBER \_\_\_\_\_  
 CABLE TYPE<sup>1</sup> \_\_\_\_\_  
 CABLE VISUAL INSPECTION RESULT (POST-INSTALLATION) \_\_\_\_\_  
 CONNECTOR TYPE(S)<sup>1</sup> \_\_\_\_\_  
 TEST EQUIPMENT MANUFACTURER/MODEL NO. \_\_\_\_\_ SERIAL NO. \_\_\_\_\_  
 CALIBRATION DUE DATE \_\_\_\_/\_\_\_\_/\_\_\_\_  
 SOURCE WAVELENGTH(S)(NM) \_\_\_\_/\_\_\_\_/\_\_\_\_  
 CONNECTOR ENDFACE QUALITY (IAW Part 5 of 2.3) \_\_\_\_\_

SOURCE CABLE NO.	DETECTOR CABLE NO.	850NM/1300NM/1310NM/1550NM WINDOW (CIRCLE ONE)							
FIBER COLORS <sup>2</sup> OR NUMBER	FIBER COLORS <sup>2</sup> OR NUMBER	ACCEPTABLE FOCT END-TO-END ATTENUATION (dB) (6E1/6E2)	ACCEPTABLE FOCT END-TO-END RETURN LOSS(dB) (6E1/6E2)	FORWARD REFERENCE POWER (6E1/6E2)	FORWARD MEASURED POWER (6E1/6E2)	FORWARD FOCT END-TO-END ATTENUATION RESULT (dB) <sup>3</sup> (6E1/6E2)	FORWARD FOCT END-TO-END RETURN LOSS RESULT (dB) <sup>4</sup> (6L1)	TEST DIRECTION <sup>5</sup> (6E1/6E2)	CABLE LENGTH (M)



NAVSEA  
STANDARD ITEM

FY-24

ITEM NO: 009-124

DATE: 25 OCT 2022

CATEGORY: II

1. SCOPE:

1.1 Title: Thermal Spray Nonskid Application; accomplish

2. REFERENCES:

- 2.1 Standard Items
- 2.2 T9074-AA-GIB-010/1687, Thermal Spray Processes for Naval Ship Machinery and Nonskid Applications
- 2.3 Association for Materials Protection and Performance (AMPP) Standards, Including Legacy NACE and SSPC Standards
- 2.4 ASTM F21, Standard Test Method for Hydrophobic Surface Films by the Atomizer Test
- 2.5 229 CFR 1915, Occupational Safety and Health Standards for Shipyard Employment, Subparts C and Z
- 2.6 ANSI/NACE SP0508, Methods of Validating Equivalence to ISO 8502-9 on Measurement of the Levels of Soluble Salts
- 2.7 ASTM D4285, Standard Test Method for Indicating Oil or Water in Compressed Air
- 2.8 ASME B46.1, Surface Texture (Surface Roughness, Waviness and Lay)
- 2.9 ASTM D4417, Standard Test Methods for Field Measurement of Surface Profile of Blast Cleaned Steel
- 2.10 ASTM D7127, Standard Test Method for Measurement of Surface Roughness of Abrasive Blast Cleaned Metal Surfaces Using a Portable Stylus Instrument
- 2.11 ISO 8502-3, Preparation of steel substrates before application of paints and related products — Tests for assessment of surface cleanliness — Part 3: Assessment of dust on steel surfaces prepared for painting (pressure-sensitive tape method)



2.12 ASTM D522, Standard Test Methods for Mandrel Bend Test of Attached Organic Coatings

2.13 A-A-59316, Commercial Item Description: Abrasive Materials; for Blasting

### 3. REQUIREMENTS:

3.1 Consider marine coatings, nonskid and abrasive blasting media to contain heavy metals (e.g., beryllium, cadmium, chromium, and lead), hexavalent chromium, crystalline silica, and/or other toxic or hazardous substances.

3.2 Maintain the following certifications for accomplishing thermal spray nonskid (TSN) operations. Information for these certifications can be found at [www.ampp.org/certification](http://www.ampp.org/certification).

3.2.1 Organizations accomplishing thermal spray nonskid application must be certified in accordance with 2.2.

3.2.2 Thermal spray application personnel and the applicable procedure must be qualified as defined in 2.2.

3.2.3 Organizations accomplishing blasting operations (abrasive and waterjetting) and color topping application must be certified in accordance with 009-32 of 2.1.

3.2.4 Personnel accomplishing abrasive blasting, ultra high pressure waterjetting (UHP WJ), high pressure waterjetting (HP WJ), or preservation must be certified in accordance with 009-32 of 2.1.

3.2.5 Personnel qualifications for low pressure water cleaning (LPWC) operations are as follows:

3.2.5.1 The contractor conducting LP WC operations to NACE/SSPC-SP WJ-4 on nonskid decks must be certified in accordance with SSPC-QP 1 of 2.3 or a NAVSEA-approved equivalent.

3.2.5.2 The onsite foreman for thermal spray nonskid application must be certified in accordance with NAVSEA Basic Paint Inspector (NBPI) course or NACE International Coating Inspector Program (CIP) Level One or higher.

3.2.6 Coating inspectors must be certified in accordance with the NAVSEA Basic Paint Inspector (NBPI) course or NACE International Coating Inspector Program (CIP) Level One or higher. The inspector must have passed the SSPC Thermal Spray Inspector Training course or NAVSEA-approved equivalent, and have a minimum of 6 months of thermal spray quality assurance (QA) experience.

3.3 Record and maintain in-process records on QA Checklist Form, Appendix A, and, for color top system application, the QA Checklist Form Appendices One, 2, 6, and 7a of 009-32 of 2.1.

3.3.1 Submit one legible copy of QA appendices in hard copy or approved transferrable media of recorded in-process information on QA Checklist Form Appendices to the SUPERVISOR within 72 hours of completion of preservation of each separate location listed in the invoking Work Item or task order.

3.3.2 QA Checklist Form Appendices of 2.1 are available at <http://www.nstcenter.biz>.

3.4 Submit one legible copy of the containment design 14 days before erecting the containment for approval by the SUPERVISOR.

3.5 Complete the water break test when required in accordance with 2.4:

3.5.1 Use deionized or distilled water.

3.5.2 Evaluate the surface for hydrocarbon contamination in accordance with 2.4. Dry the surface using a lint free cloth.

3.5.3 The “testing of processing environments” described in 2.4 does not apply.

3.6 For TSN, conduct Film Thickness (FT) measurements as follows:

3.6.1 A Type 2 gauge in accordance with SSPC-PA 2 of 2.3 with a probe diameter of 0.20 inches or smaller, a sample diameter of 0.12 inches or smaller, and capable of measuring TSN FT from 25 to 150 mils must be used.

3.6.2 For FT measurements, one spot measurement is the average of 10 individual gauge readings that are made along a 24-inch straight-line perpendicular to the application direction. Do not place FT probe on atypical high spots or irregularities (e.g., spatter).

3.7 Product storage:

3.7.1 Store TSN wire in a dry place in accordance with manufacturer’s storage requirements. Document the name of the thermal spray wire, manufacturer, batch/lot number, and date of expiration on QA Checklist Form, Appendix A. Record the batch/lot number for the thermal spray wire material in “Product Information” section on QA Checklist Form, Appendix A.

3.7.2 Store and monitor liquid coatings in accordance with 009-32 of 2.1.

3.8 Do not use partial kits when using multiple component coatings that are to be applied to the TSN in overlap areas and the prepared steel bordering the TSN application, unless using verified proportioning equipment or other verified measuring equipment (gravimetric).

3.9 Install masking material appropriate for blasting. For thermal spray masking, use material such as DeWAL Industries Inc. DW501 or equivalent material as approved by NAVSEA, for protection of equipment and items in work area not to be coated. Remove masking material upon completion of final TSN coating.

3.9.1 Mask flight deck tie-downs, recessed flight deck lights, deck fittings, and protrusions that are not to be coated with the TSN using masking material. Masking must extend 1-2 inches onto the deck from the welded edge of tie-downs, recessed flight deck lights, deck fittings, and protrusions.

3.10 Clean polyethylene shoe coverings must be worn when walking on prepared or coated surfaces. Shoe coverings must be selected that do not degrade and contaminate surfaces. Use of adhesive tape (e.g., duct tape) as shoe covering is prohibited.

3.11 Erect and maintain a containment structure and ventilation system over the designated work area in accordance with the design approved by the SUPERVISOR.

3.11.1 The containment must include a sub-containment enclosure, or spray equipment shrouding, within the overall containment. The enclosure must meet the dust mitigation requirements of 2.5. The enclosure, or spray equipment shrouding, must contain dust generated by the TSN process and capture dust in a bag house or other dust collection equipment as approved by the SUPERVISOR.

(V)(G) “CONTAINMENT AND VENTILATION INSTALLATION”

3.11.2 Verify installation of containment structure and operation of ventilation and dust collection systems in accordance with the design approved by the SUPERVISOR.

3.11.2.1 Containment and associated ventilation systems are to be in place and operational prior to start of any surface preparation operations and must remain in place and operational until cure to service of color topping.

(V) “VERIFY CONTAINMENT AND ENCLOSURE INSTALLATION”

3.11.3 Move and install containment and enclosure to additional work areas.

(V) “ENVIRONMENTAL READINGS”

3.12 Measure ambient and substrate surface temperatures, relative humidity, and dew point inside the containment and within close proximity to the enclosure. These data must be collected and recorded from the beginning of abrasive blasting through cure to service of the color topping.

3.12.1 Environmental readings must be measured and recorded at a minimum of once per hour with a data logger. Measure and record a manual reading once every 24 hours and at every (G)-point with a separate calibrated device independent of the data logger to confirm data logger readings. These manual readings must be documented on QA Checklist Form, Appendix A, and, for color top system application on QA Checklist Form, Appendix 1 of 009-32 of 2.1.

3.12.2 Accomplish Secondary Surface Preparation and TSN application process under the following conditions: the ambient air and deck temperature within the sub-containment must be maintained at a minimum of 40 degrees Fahrenheit and a minimum of 5 degrees Fahrenheit above the dew point. The maximum relative humidity within the sub-containment must be maintained at less than 50 percent.

3.12.3 For the color top system, measure and record the environmental readings from prior to the start of application of the coatings until 48 hours of creditable cure time as defined in 009-32 of 2.1. For coatings that fully cure to service in less than 48 hours, as defined on their NAVSEA-reviewed ASTM F718 data sheets, environmental readings for the final coat must be measured and recorded until the coating's cure to service time is reached.

3.13 Remove existing deck coating in the TSN application area within the containment using vacuum, self-contained UHP WJ equipment in accordance with Table One, Column A.

3.13.1 Remove existing deck coating using UHP WJ from an additional 12 to 18 inches on each side of the intended TSN area to allow for a tie-in area with MIL-PRF-24667 nonskid.

(V) "PRIMARY SURFACE PREPARATION"

3.13.2 Verify primary surface preparation is in accordance with Table One, NACE/SSPC-SP WJ-2/L of 2.3. Document primary surface preparation on QA Checklist Form, Appendix A.

(I)(G) "CONDUCTIVITY MEASUREMENT"

3.13.3 Accomplish surface conductivity measurements on the prepared deck. One reading must be taken for the first 200 square feet. Additional readings must be taken for every additional 400 square feet or less. Conductivity measurements must not exceed 30 micro-siemens/cm. Conductivity samples must be collected using a product that meets the requirements of 2.6. Document on QA Checklist Form, Appendix A. Accomplish surface conductivity measurement within 8 hours prior to abrasive blasting.

3.13.3.1 Clean areas where conductivity exceeds requirements using LP WC equipment with potable water to NACE/SSPC-SP WJ-4 of 2.3. Dry the affected areas and remove any standing water. Accomplish surface conductivity measurements on affected areas in accordance with 3.13.3.

(I)(G) "CLEANLINESS PRIOR TO ABRASIVE BLASTING"

3.13.4 Accomplish degreasing/cleaning prior to surface preparation to ensure that the surface is free of contaminants in accordance with SSPC-SP 1 of 2.3.

3.13.4.1 Accomplish a visual water break test on the cleaned surface in accordance with paragraph 3.5. One water break test must be accomplished on every 200 square feet of the waterjet cleaned surface. In addition, water break tests must be accomplished on stained or discolored areas that visually indicate hydrocarbon or other contamination. Accomplish degreasing/cleaning of areas with hydrocarbon or other contamination in accordance with SSPC-SP 1 of 2.3 until the surface is free of hydrophobic contaminants as evident by water droplets spreading immediately to form a thin, continuous uniform water film. Document surface cleanliness on QA Checklist Form, Appendix A and document the water break test results on QA Checklist Form, Appendix A.

3.14 Prepare surfaces to be coated with TSN to a white metal blast, SSPC-SP 5/NACE 1 of 2.3 in accordance with Table One, Column B.

3.14.1 Blast media must conform to SSPC-AB 1 of 2.3 or A-A-59316 of 2.13, and be a blend of 50 percent 16-mesh grit aluminum oxide and 50 percent 24-mesh grit aluminum oxide. Submit one legible copy, in hard copy or approved transferrable media, of the blast media conformance data package to the SUPERVISOR prior to blasting.

3.14.2 Initiate abrasive blasting within 10 hours of accomplishing UHP WJ in accordance with 3.13.1. When surface profile is not established within 10 hours the surface cleanliness must be verified in accordance with 3.13.2, 3.13.3, and 3.13.4.

3.14.3 Recycling or re-use of the abrasive is prohibited.

(V) "VERIFY COMPRESSED AIR QUALITY"

3.14.4 Compressed air must be free of water and oil in accordance with 2.7.

3.14.5 Remove abrasive media using a vacuum equipped with a nonmarring hose. Remaining abrasive and dust in TSN application area must be blown down with clean, dry air to a localized area and completely removed with the vacuum.

(I)(G) "SECONDARY SURFACE PREPARATION"

3.14.6 Verify secondary surface preparation is in accordance with Table One, Column B including the welds. Document secondary surface preparation on QA Checklist Form, Appendix A.

(I)(G) "SURFACE PROFILE"

3.14.7 Measure surface texture as defined in 2.8 using Root Mean Square Slope (RΔq), and document the surface texture data on QA Checklist Form, Appendix A. Measure surface profile as defined in 2.9 and document the profile data on QA Checklist Form, Appendix A.

3.14.7.1 Take one RΔq measurement every 400 square feet in accordance with 2.10. One RΔq measurement is defined as the mean of 5 individual readings. The measured RΔq must be 0.45 or greater.

3.14.7.2 Take two profile measurements every 100 square feet using Method B of 2.9. One profile measurement is defined as the mean of 10 individual gauge readings. The 10 individual gauge readings and the mean must be documented. The profile must be between 4.0 and 10.0 mils. Profile must not be measured within one inch of any weld or on any uneven, gouged, or pitted surface.

(I)(G) “DUST TEST”

3.14.8 Accomplish a surface cleanliness inspection for dust and document on Appendix A. Surface dust must be a maximum of Rating 2, Class 2, of 2.11. Three individual readings must be taken for every 400 square feet. Individual tape samples must be retained and applied to the back of QA Checklist Form, Appendix A and labeled with the date, time, and work area or zone.

3.15 Accomplish thermal spray application in accordance with Table One.

3.15.1 Initiate TSN coating application within 10 hours of the completion of abrasive blasting in accordance with 3.14. When TSN application is not initiated within 10 hours, the surface cleanliness must be verified in accordance with 3.14.6 and 3.14.8.

(V) “VERIFY SECONDARY SURFACE PREPARATION PRIOR TO TSN APPLICATION”

3.15.2 Verify just prior to TSN application that the surface still satisfies requirements in Table One, Column B.

3.15.3 Prepare witness coupons in accordance with the following:

3.15.3.1 Prepare witness coupons within 10 hours of initiating TSN application during each work shift.

3.15.3.2 Witness coupons must consist of three cold-rolled steel test plates of dimensions 2 inches by 8 inches by 0.0625 inches or as approved by NAVSEA. Clean each witness coupon plate using the same cleaning procedures used on the deck to satisfy the cleaning requirements of 3.13.4. Abrasive blast each witness coupon plate using the same abrasive blasting procedures used on the deck to satisfy the surface preparation requirements of 3.14.6 and 3.14.7. Accomplish one surface profile measurement in accordance with Method B of 2.9 on

each witness coupon plate. Record the profile for witness coupons on QA Checklist Form, Appendix A.

3.15.3.3 Secure the witness coupons to masked tie-downs within the TSN application area at the start of each work shift such that the witness coupons do not move during thermal spray application. Space the witness coupons uniformly across the application area. The witness coupons must remain in place during the application of the first layer of TSN to the deck so that the witness coupons are coated simultaneously with the coating of the deck.

3.15.4 Accomplish TSN application to designated deck areas using the qualified procedure of 2.2.

3.15.4.1 Accomplish the requirements of 3.12 for environmental readings.

(I) “THERMAL HAND SPRAY AND ROBOTIC SPRAY APPLICATION MACHINE SETTINGS”

3.15.4.2 Verify and document thermal hand spray and robotic spray machine settings and spray parameters are in accordance with the qualified procedure of 2.2 at the start of each work shift on QA Checklist form, Appendix A.

3.15.4.3 Apply the TSN coating 6 to 9 inches beyond the designated TSN application area to facilitate the tie-in area to the surrounding MIL-PRF-24667 nonskid coating system.

3.15.4.4 Apply TSN 24 to 36 inches from the inboard face of the wheel stops and other areas as directed by the SUPERVISOR.

3.15.4.5 Overlap TSN between work zones in accordance with qualified procedure of 2.2.

3.15.4.6 Document start and end time for the application of each layer of thermal spray on QA Checklist Form, Appendix A.

(I) “MANDREL BEND WITNESS COUPONS”

3.15.5 Test the three witness coupon plates immediately following the application of the first layer of TSN after the plates cool to below 120 degrees Fahrenheit. Take three individual FT gauge readings on each witness coupon plate. Record each measurement on QA Checklist Form, Appendix A. Accomplish Test Method B – Cylindrical Mandrel Test of 2.12 on each panel. The mandrel rod diameter must be 2.25 inches. The witness coupon plates must be bent to 180 degrees and visually inspected without magnification for spalling, flaking or delamination in accordance with Attachment A. Any spalling, flaking, or delamination of the coating on any one of the three witness coupon plates must constitute a mandrel bend test failure. Cracking without spalling, flaking or delamination is acceptable.

Flaking within 0.125 inches from the witness coupon plate edges is acceptable. Record the mandrel test results on QA Checklist Form, Appendix A. The witness coupon plates must be labeled with the date, time, and location, and must be provided to the SUPERVISOR upon request.

3.15.5.1 Notify the SUPERVISOR of any mandrel bend test failure. A mandrel bend test failure must require removal of TSN applied to the work zone during that work shift in accordance with 3.13. A new set of three witness coupon plates must be installed in the work zone at the start of the work shift. The work zone must be re-blasted in accordance with 3.14 and TSN installed in accordance with 3.15.

(V) “THERMAL SPRAY VISUAL INSPECTION”

3.15.6 Accomplish a visual inspection of each layer of the TSN system. There must be no blistering, delamination, spalling, or cracking of the TSN coating. The nonskid surface must be visually free of drips, beads, and spatter greater than one square inch in area. Retain drips, beads, and spatter smaller than one square inch that are adherent and that cannot be dislodged by a dull putty knife. When determining FT conformance to the qualified procedure of 2.2 in the overlap area, the coating FT must be in accordance with the requirements in the qualified procedure. Document inspection on QA Checklist Form, Appendix A.

3.15.6.1 Repair blistering, delamination, spalling, or cracking of the TSN coating using TSN hand spray equipment application in accordance with Attachment C or D based on the area for each repair or cumulative repair area, as defined by the SUPERVISOR. Apply TSN to individual and cumulative repair areas in accordance with Attachment C or D as defined by the SUPERVISOR. Individual and cumulative TSN hand spray application area must not exceed 20 square feet in each 200 square foot area. Individual and cumulative blistering, delamination, spalling, or cracking of the TSN coating in excess of 20 square feet must require complete removal and reapplication of TSN in the entire 200 square foot area in accordance with Attachment B.

(I)(G) “FT MEASUREMENTS”

3.15.7 Accomplish FT measurements on the TSN only after the deck has cooled to less than 120 degrees Fahrenheit.

3.15.7.1 Take deck FT measurements on final TSN system in accordance with 3.6. Five spot measurements as defined in 3.6.2 must be taken every 200 square feet. The measurements must be recorded on QA Checklist Form, Appendix A.

3.15.7.2 Evaluate areas of low FT identified in 3.15.7.1 by taking one FT reading at 3 inch intervals in 8 equally spaced directions radiating outward from the initial low FT reading as shown in Attachment E, until 2 consecutive conforming FT readings are achieved or until no additional measurements are possible. Record FT measurements and



submit a sketch defining the areas of low FT in hard copy, or approved transferrable media, to the SUPERVISOR.

3.15.7.3 Verify surface cleanliness and apply additional TSN in areas of low FT using TSN hand spray or robotic spray application equipment to meet the FT requirements of the qualified procedure of 2.2.

3.15.7.4 Evaluate areas of TSN with a FT greater than 150 mils identified in 3.15.7.1 by taking one FT reading at 3 inch intervals in 8 equally spaced directions radiating outward from the initial FT reading greater than 150 mils as shown in Attachment E, until 2 consecutive conforming FT readings are achieved or until no additional measurements are possible. Record FT measurements and submit a sketch defining the areas of FT in excess of 150 mils in hard copy, or approved transferrable media, to the SUPERVISOR.

3.15.7.5 TSN with FT greater than 150 mils, in areas larger than one square inch must be removed to bare steel in accordance with Attachment C or D based on the area for each individual or cumulative area with FT greater than 150 mils, as defined by the SUPERVISOR. Apply TSN to individual and cumulative repair areas in accordance with Attachment C or D as defined by the SUPERVISOR. Individual and cumulative TSN hand spray application areas must not exceed 20 square feet in each 200 square foot area. Individual and cumulative TSN areas with FT greater than 150 mils in excess of 20 square feet must require complete TSN removal and reapplication of TSN in the entire 200 square foot area in accordance with Attachment B.

3.16 Accomplish cleaning of TSN in accordance with Table One, Column E following the completion of TSN application and prior to application of sealer.

3.16.1 For TSN installation areas less than 200 square feet, sweep TSN area with a stainless steel wire or a stiff nylon bristle brush/broom as approved by the SUPERVISOR to remove thermal spray dust and non-adherent TSN peaks within 24 hours of completing TSN spray application. Remove thermal spray dust and non-adherent peaks using a vacuum with a non-marring hose. Remaining dust and non-adherent peaks in the TSN installation area must be blown down with clean, dry air to a localized area and completely removed with the vacuum.

3.16.2 For TSN installation areas larger than 200 square feet, complete TSN installation to the entire TSN installation work zone. Sweep TSN installation work zone with a stainless steel wire or a stiff nylon bristle brush/broom as approved by the SUPERVISOR to remove thermal spray dust and non-adherent TSN peaks within 48 hours of completing TSN spray application. Remove thermal spray dust and non-adherent peaks using a vacuum with a non-marring hose. Remaining dust and non-adherent peaks in the TSN area must be blown down with clean, dry air to a localized area and completely removed with the vacuum.

3.16.3 For TSN installation areas larger than 200 square feet, clean entire TSN work zone using potable water and LP WC equipment to NACE/SSPC-SP WJ-4 of 2.3. Operate the LP WC equipment with potable water at 2,500 to 3,000 PSI. The LP WC equipment must

include a rotating or reciprocating high pressure bar fitted with LP WC nozzles and a vacuum water and debris collection system. The nozzle type, such as fan or jet, and nozzle angles must be configured to provide the necessary cleaning pattern while not causing visible etching, patterns, or other damage on the TSN. The vacuum system must be configured to remove debris and water from the deck rapidly enough to prevent the formation of puddles on the TSN.

3.16.4 For TSN installation areas larger than 200 square feet, accomplish a visual cleanliness inspection without magnification, for complete removal of surface contamination. Secure the cleaned area from traffic (e.g., personnel and equipment) and allow area to dry for a minimum of 12 hours at a maximum relative humidity of 70 percent and minimum deck temperature of 50 degrees Fahrenheit.

(I)(G) “TSN CLEANLINESS”

3.16.5 Verify TSN surface is free of contaminants in accordance with SSPC-SP 1, paragraph 2.1, of 2.3. Accomplish water-break tests on any discoloration or spots that visually indicate hydrocarbon or other contamination. Accomplish degreasing/cleaning of areas with hydrocarbon or other contamination areas in accordance with SSPC-SP 1 of 2.3 until the surface is free of hydrophobic contaminants as evident by water droplets spreading immediately to form a thin, continuous uniform water film. Document inspection result on QA Checklist Form, Appendix 2 of 009-32 of 2.1, as specified in 3.13.4.1.

3.16.5.1 For any area of TSN that exhibits water droplets that do not spread immediately to form a thin, continuous uniform water film during the water-break test after degreasing/cleaning, conduct a black light inspection using a high intensity UV-A flashlight to identify the location of hydrocarbons or other contamination. Only clean/degrease locations where the presence of hydrocarbons or other contaminants is confirmed by the black light inspection.

(V) “SEALER APPLICATION”

3.17 Verify just prior to sealer application that the TSN is clean and dry in accordance with 3.16.

3.17.1 Accomplish the requirements of 3.12.1 for environmental readings.

3.17.2 Mask outermost 6 to 18 inches of TSN to prevent application of sealer to TSN tie-in areas where overcoating with MIL-PRF-24667 nonskid is required.

3.17.3 Apply NAVSEA-approved TSN sealer in accordance with Table One, Column F within 24 hours of completing TSN cleaning in accordance with 3.16. Document application of the TSN sealer on QA Checklist Form, Appendix 6 of 009-32 of 2.1.

(V) “DARK GRAY COLOR TOP APPLICATION”

3.18 Verify just prior to dark gray color top application that the TSN sealer is cured to support foot traffic in accordance with the NAVSEA-reviewed ASTM F718.

3.18.1 Accomplish the requirements of 3.12.1 for environmental readings.

3.18.2 Prepare companion panels in accordance with the following:

3.18.2.1 Prepare companion panels within 24 hours of the sealer curing to support foot traffic.

3.18.2.2 Companion panels must be cold-rolled steel or aluminum test plates that are a minimum of 4 inches by 6 inches by 0.02 inches or as approved by NAVSEA. Clean each companion panel by wiping with cleaning solvent in accordance with SSPC-SP 1 of 2.3. Hand sand one side of each companion panel using 80 to 120 grit sand paper to produce a uniform pattern of scratches.

3.18.2.3 For sealed TSN that will be coated with the dark gray color topping, two companion panels are required for the first 1,000 square feet, and one panel is required for each additional 1,000 square feet or less. Orient the companion panels such that color topping will be applied to the hand sanded surface. The panels must be secured to tie down fittings or the deck such that they will not be dislodged during color topping spray and roller application. Space the companion panels uniformly across the color topping application area so that the panels are coated with color topping simultaneously with the coating of the sealed TSN on the surrounding deck.

3.18.3 Mask outermost 6 to 18 inches of TSN to prevent application of dark gray color topping to TSN tie-in areas where overcoating with MIL-PRF-24667 nonskid is required.

3.18.4 Inspect the location and color of required VLA markings in accordance with 009-32 of 2.1, Naval Air Warfare Center Aircraft Division (NAWCAD) Class Guidance Drawings, Air Capable Ship Aviation Facilities Bulletin, Amphibious Assault Ship Aviation Facilities Bulletin, Shipboard Aviation Resume (NAECENG-7576), VLA General Service Bulletin No. 8 (latest revision) or by contacting the local NAWC (CAFSU/ASIR) Field Office. VLA markings are not to be applied over dark gray color topping.

3.18.4.1 Mask VLA marking areas to prevent application of dark gray color top. Overlap of VLA marking colors onto dark gray must not exceed 1/2 inch.

3.18.5 Mix and apply NAVSEA-approved dark gray color top in accordance with the product's NAVSEA-reviewed ASTM F718 data sheet or as approved by NAVSEA. Document application of the TSN color top on QA Checklist Form, Appendix 6 of 009-32 of 2.1.

3.18.5.1 Complete application of dark gray color top to sealed TSN in the work zone, excluding areas that will receive VLA markings and masked areas of 3.18.3,

within 5 days of the sealer curing to support foot traffic in accordance with the ASTM F718. Document dark gray color top application in accordance with Table One, Column G.

(V) “WFT MEASUREMENTS – DARK GRAY COLOR TOPPING”

3.18.5.2 Accomplish in-process WFT measurements on companion panels immediately after they have been coated with dark gray color top. One WFT measurement per companion panel is required after spray and roller application. WFT measurements must comply with Table One, Column G. Record the WFT readings on QA Checklist Form, Appendix 7A of 009-32 of 2.1.

3.18.5.3 Allow NAVSEA-approved dark gray color top to cure to support foot traffic in accordance with the NAVSEA-reviewed ASTM F718 product data sheet. Remove masking in areas that will receive VLA markings.

(V) “VLA MARKING COLOR TOP APPLICATION”

3.19 Verify just prior to VLA marking color top application that the dark gray color top has cured to support foot traffic in accordance with the NAVSEA-reviewed ASTM F718.

3.19.1 Accomplish the requirements of 3.12.1 for environmental readings.

3.19.2 Prepare companion panels in accordance with the following:

3.19.2.1 Prepare companion panels within 24 hours of the dark gray color top curing to support foot traffic.

3.19.2.2 Companion panels must be cold-rolled steel or aluminum test plates that are a minimum of 4 inches by 6 inches by 0.02 inches or as approved by NAVSEA. Clean each companion panel by wiping with cleaning solvent in accordance with SSPC-SP 1 of 2.3. Hand sand one side of each companion panel using 80 to 120 grit sand paper to produce a uniform pattern of scratches.

3.19.2.3 For areas less than 1,000 square feet of TSN to be coated with VLA marking color top, secure one companion panel to tie down fittings or the deck so that the panel will not be dislodged during color top spray and roller application. The companion panel must be secured such that the color topping will be applied to the hand sanded surface. Locate the companion panel so that the panel is coated with color topping simultaneously with the coating of the sealed TSN.

3.19.3 Mask TSN with dark gray color top around VLA marking areas. Overlap of VLA marking colors onto dark gray must not exceed 1/2 inch.

3.19.4 Inspect the location and color of required VLA markings in accordance with 009-32 of 2.1, Naval Air Warfare Center Aircraft Division (NAWCAD) Class Guidance Drawings, Air Capable Ship Aviation Facilities Bulletin, Amphibious Assault Ship Aviation

Facilities Bulletin, Shipboard Aviation Resume (NAECENG-7576), VLA General Service Bulletin No. 8 (latest revision) or by contacting the local NAWC (CAFSU/ASIR) Field Office.

3.19.5 Mix and apply each VLA marking color of the NAVSEA-approved color top in accordance with the product's NAVSEA-reviewed ASTM F718 data sheet or as approved by NAVSEA. Document application of the TSN color top on QA Checklist Form, Appendix 6 of 009-32 of 2.1.

3.19.5.1 Complete application of VLA color top to sealed TSN in the work zone, excluding masked areas of 3.18.3, within 7 days of the sealer curing to support foot traffic in accordance with the ASTM F718. Document VLA marking color top application in accordance with Table One, Column H.

(V) "WFT MEASUREMENTS – VLA MARKING COLOR TOPPING"

3.19.5.2 Accomplish in-process WFT measurements companion panels immediately after they have been coated with VLA marking color topping. One WFT measurement per companion panel is required after spray and roller application. WFT measurements must comply with Table One, Column H. Record the WFT readings on QA Checklist Form, Appendix 7A of 009-32 of 2.1.

3.19.5.3 Allow NAVSEA-approved VLA marking color topping to cure to support foot traffic in accordance with the NAVSEA-reviewed ASTM F718 product data sheet. Remove masking from area around VLA markings.

(I)(G) "COLOR TOPPING HOLIDAY INSPECTION"

3.19.6 Verify color topping coverage. Touch-up any holidays in the color topping as directed by the SUPERVISOR.

3.19.6.1 Remove all masking from the TSN installation work zone.

(V) "INSTALL MIL-PRF-24667 NONSKID ADJACENT TO TSN"

3.20 Accomplish MIL-PRF-24667 nonskid system application to tie in areas, deck tie-down fittings, areas around recessed flight deck lights, and to areas around other designated deck fittings in accordance with 009-32 of 2.1.

3.20.1 Apply MIL-PRF-24667 nonskid system in accordance with 009-32 of 2.1, table and line citation in the Work Item or task order, for the tie-in areas. The MIL-PRF 24667 nonskid system must overlap onto the newly applied TSN up to the edge of the TSN color topping. Overlap of MIL-PRF-24667 nonskid system onto TSN color topping must not exceed 1/2 inch.

3.20.2 Accomplish coating of deck tie-down fittings, areas around recessed flight deck lights, and other designated deck fittings in accordance with 009-32 of 2.1. The coating must overlap onto surrounding TSN up to the edge of the TSN color topping. Overlap of the coatings onto TSN color topping must not exceed 1/2 inch.

#### 4. NOTES:

##### 4.1 Clarification of terms:

4.1.1 The term tie-in area is defined as the area where MIL-PRF 24667 nonskid is applied over the prepared steel deck and the outer edge of the TSN.

4.1.2 The term overlap is defined as the area where newly applied TSN is applied to prepared steel and extends over adjacent retained TSN.

4.1.3 The color top system is defined as a NAVSEA-approved system that includes a clear TSN sealer, dark gray color topping, and all other color toppings required to install Visual Landing Aid (VLA) markings.

4.1.4 The term repair area is defined as the individual locations requiring repair or replacement as defined by the SUPERVISOR and not the cumulative sum of all individual sites of TSN damage or delamination on the entire deck. The SUPERVISOR must determine when individual repair areas are to be grouped into one large repair area or discretely repaired as individual areas.

4.1.5 The term back roll is defined as the process of using a 1/4 inch or 3/8 inch nap roller, without additional color topping or a roller tray, to reroll uncured sealer and color topping on TSN to minimize the amount of liquid coating on the TSN while ensuring complete coverage and a uniform color.

4.2 To reduce the risk of TSN shrinkage stress creating in-service cracks, avoid positioning the robotic TSN installation system such that the point at which the short axis of the thermal spray machine reverses direction (i.e. the position where the thermal spray heads stop moving in one direction and then move back in the other direction) is over a deck weld.

4.3 Orient enclosure parallel to ship's main axis. Orient the long axis of the thermal spray machine inside the enclosure parallel to the ship's main axis.

ATTACHMENT A

Mandrel Bend Test Pass/Fail Coupons

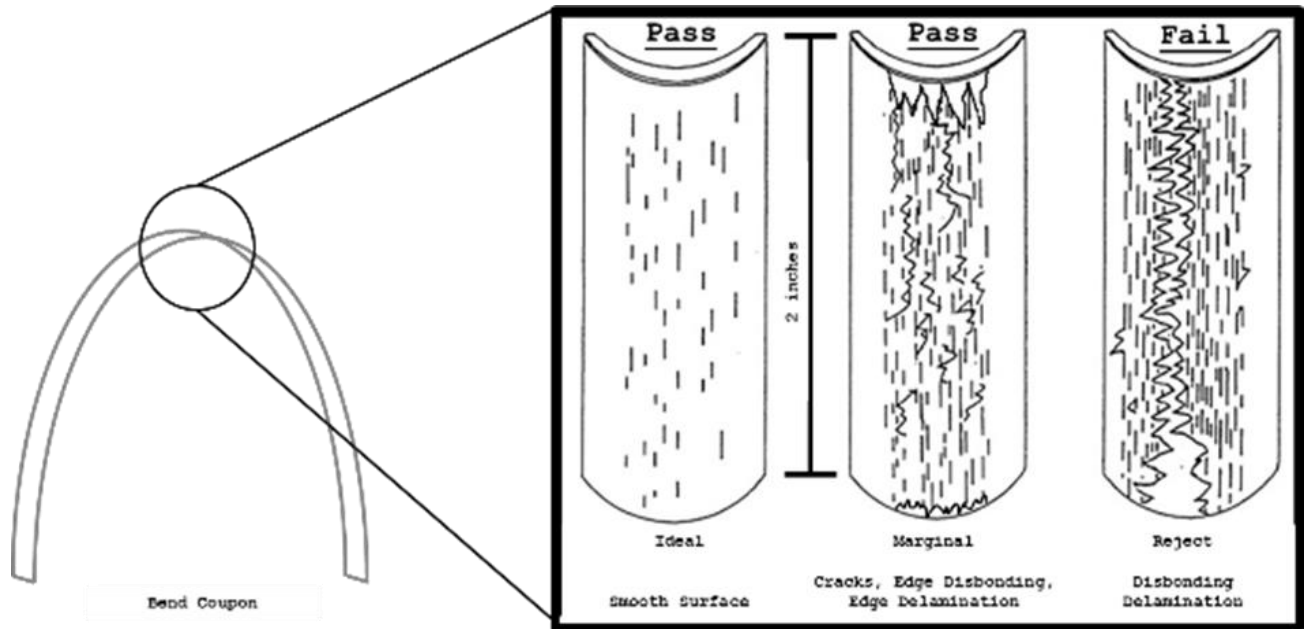

## ATTACHMENT B

### Repair Procedure for Greater than 200 Square Feet of TSN that is Removed by HP WJ and TSN Installation Using TSN Robotic and Hand Spray Application Equipment

1. The repair area must be designated and marked by the NAVSEA-approved Technical Representative.
2. As directed by the SUPERVISOR, install steel masking plates around the edges of the repair area in accordance with Figures B-1 and B-2, to maintain a straight edge on retained TSN. The masking plates must be between 1/16-inch and 1/8-inch thick, a minimum of 6 inches wide, and placed along the edge of the repair in a manner such that some part of the plate is in direct contact with the deck in accordance with Figure B-3.
3. As directed by the SUPERVISOR and in accordance with Table One, Line 2, Column A, remove TSN within the repair area with HP WJ and maintain pressure between 22,000 and 25,000 PSI. Conduct ten HP WJ passes over entire repair area to ensure complete TSN removal.
  - a. HP WJ pressures in excess of 25,000 PSI will damage the retained TSN under the steel masking plates.
4. Hand sand TSN edge using 80 – 120 grit paper or pad to remove sharp burrs or slivers along the edge of retained TSN.
5. Accomplish the QA checkpoints in accordance with 3.13.2, 3.13.3, 3.13.4 and document the results on QA Checklist Form, Appendix A.
6. Install steel masking plates to protect the retained TSN from abrasive blasting.
  - a. Align steel masking plates for abrasive blasting with the edge of the retained TSN in accordance with Figure B-4.
  - b. Place steel masking plate so that some part of the masking plate must be in direct contact with the retained TSN on the deck in accordance with Figure B-3.
7. In accordance with Table One, Line 2, Column B Abrasive blast the repair area in accordance with paragraph 3.14 and conduct QA checkpoints in accordance with paragraph 3.14. Remove steel masking plates and visually inspect the repair area, including the edge of adjacent, adherent, retained TSN, to verify NACE 1/SSPC-SP 5 of 2.3. Document the results on QA Checklist Form, Appendix A.
8. Install steel masking plates along the repair area for application of the first layer of TSN.
  - a. Install steel masking plates to protect the retained TSN edge from TSN installation overspray.



b. Place the steel masking plates along the edge of the repair area such that some part of the plate is in direct contact with the deck in accordance with Figure B-2. Align steel masking plates to extend 1/8 inch beyond the retained TSN edge to create a “shadow mask” in accordance with Figure B-5. Steel masking plates extending less than 1/16 inch beyond the retained TSN edge or greater than 3/16 inch beyond the retained TSN edge must be re-positioned in accordance with Figure B-5 before TSN robotic spray application.

9. In accordance with Table One, Line 2, Column C, accomplish robotic or hand thermal spray application of first layer of TSN and QA checkpoints in accordance with paragraph 3.15. Record the mandrel test results on QA Checklist Form, Appendix A. Hand spray applications must not exceed 800 square feet in any single repair area.

10. Install steel masking plates for the second layer of TSN in accordance with Figure B-6.

a. Install steel masking plates to protect the retained TSN edge from TSN installation overspray.

b. Place the steel masking plates along the edge of the repair area such that some part of the plate is in direct contact with the deck in accordance with Figure B-2. Align steel masking plates with the retained TSN edge in accordance with Figure B-3.

11. In accordance with Table One, Line 2, Column D, accomplish robotic or hand thermal spray application of second layer of TSN and document QA checkpoints in accordance with paragraph 3.15. Record the FT results on QA Checklist Form, Appendix A. For all hand spray applications, ten spot measurements as defined in 3.6.2 must be taken for every 200 square feet or less.

12. Remove steel masking plates and in accordance with Table One, Line 2, Column E, clean TSN repair area and document cleaning in accordance with paragraph 3.16 on QA Checklist Form, Appendix A.

13. In accordance with Table One, Line 2, Column F, apply sealer to TSN in the repair area and document sealer application in accordance with paragraph 3.17 on QA Checklist Form, Appendix 6 of 009-32 of 2.1.

a. Overlap of sealer onto areas of retained TSN must not exceed 1/2 inch.

14. In accordance with Table One, Line 2, Column G, apply dark gray color top to TSN in the repair area in accordance with paragraph 3.18 and document installation on QA Checklist Form, Appendix 6 of 009-32 of 2.1.

a. Overlap of dark gray onto areas of retained TSN must not exceed 1/2 inch.

15. In accordance with Table One, Line 2, Column H, apply VLA marking color top to TSN in the repair area in accordance with paragraph 3.19 and document on QA Checklist Form, Appendix 6 of 009-32 of 2.1.

- a. Overlap of VLA Marking colors onto areas of retained TSN must not exceed 1/2 inch.
- b. Overlap of VLA Marking colors on dark gray color top must not exceed 1/2 inch.

16. Accomplish MIL-PRF-24667 nonskid system application to tie in areas, deck tie-down fittings, areas around recessed flight deck lights, and to areas around other designated deck fittings in accordance with 009-32 of 2.1.

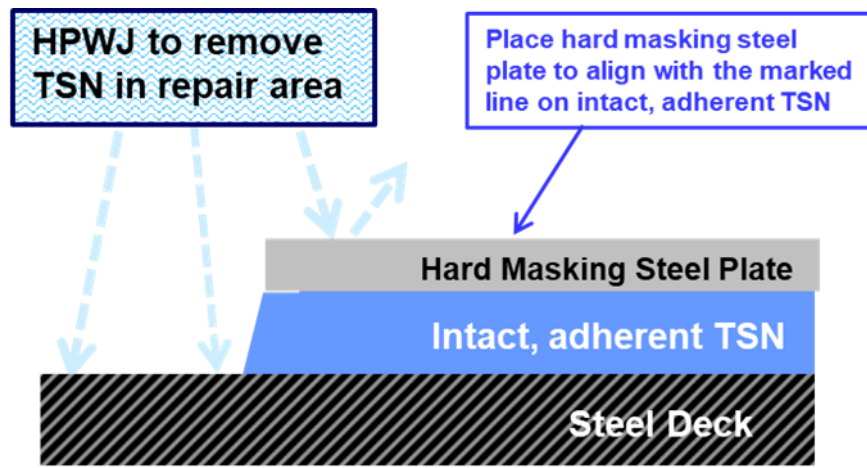

Figure B-1: Cross section view of masking alignment for TSN removal using HP WJ

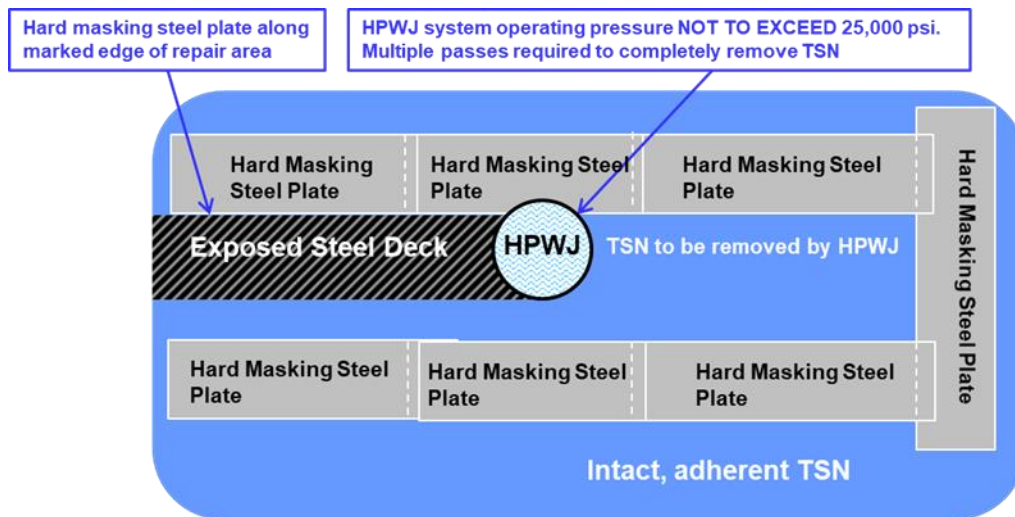

Figure B-2: Top view of masking alignment for TSN removal using HP WJ

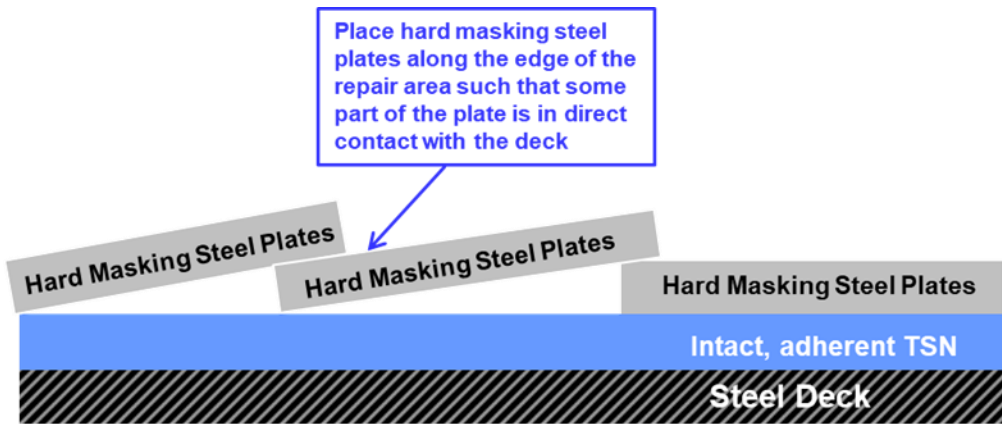

Figure B-3: Cross section view of hard masking plates placed along the edge of a TSN repair area for HP WJ

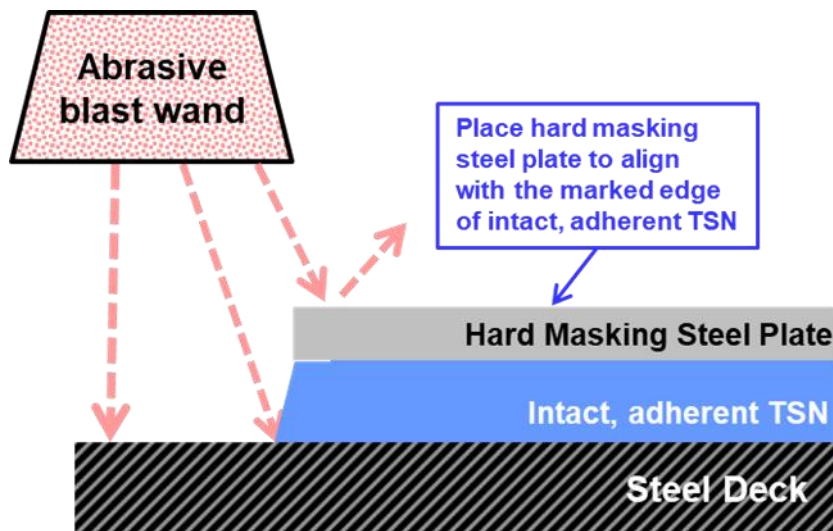

Figure B-4: Cross section view of masking alignment for abrasive blasting after HP WJ removal

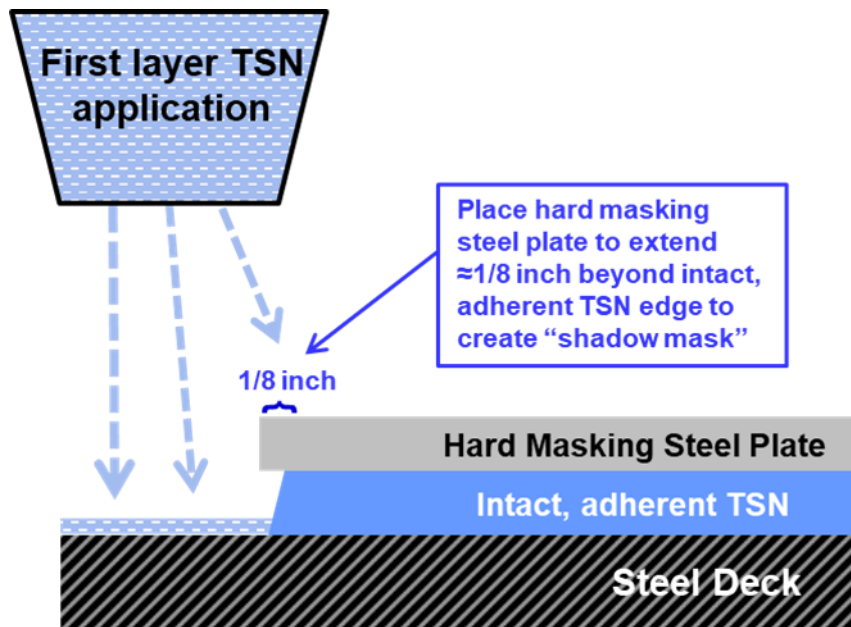

Figure B-5: Cross section view of shadow mask for first layer of TSN

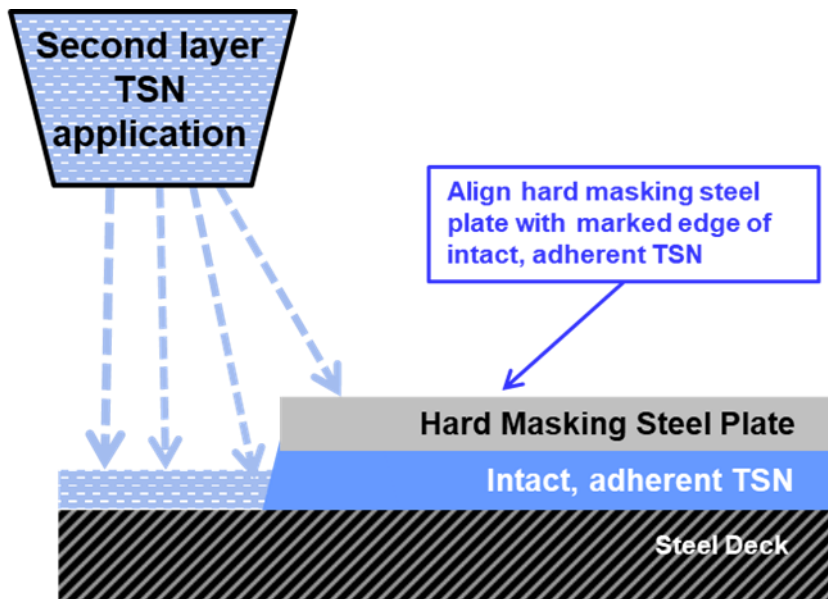

Figure B-6: Cross section view of second layer of TSN adjacent to intact, adherent TSN

## ATTACHMENT C

### Repair Procedure for 20 to 200 Square Foot Areas of TSN that Requires Removal by HP WJ and TSN Installation Using TSN Hand Spray Application Equipment

1. The repair area must be designated by the NAVSEA-approved Technical Representative.
2. As directed by the SUPERVISOR, install steel masking plates around the edges of the repair area in accordance with Figures C-1 and C-2, to maintain a straight edge on retained TSN. The masking plates must be a between 1/16 and 1/8-inch thick, a minimum of 6 inches wide, and placed along the edge of the repair in a manner such that some part of the plate is in direct contact with the deck in accordance with Figure C-3.
3. As approved by the SUPERVISOR and in accordance with Table One, Line 3, Column A, remove TSN within the repair area with HP WJ and maintain pressure between 22,000 and 25,000 PSI. Conduct ten HP WJ passes over entire repair area to ensure complete TSN removal.
  - a. HP WJ pressures in excess of 25,000 PSI will damage the retained TSN under the steel masking plates.
4. Hand sand TSN edge using 80 – 120 grit paper or pad to remove sharp burrs or slivers along the edge of retained TSN.
5. Accomplish the QA checkpoints in accordance with 3.13.2, 3.13.3, 3.13.4 and document the results on Repair QA Checklist Form, Appendix b.
6. Install steel masking plates to protect the retained TSN from abrasive blasting.
  - a. Align steel masking plates for abrasive blasting with the edge of the retained TSN in accordance with Figure C-4.
  - b. Place steel masking plate so that some part of the masking plate must be in direct contact with the retained TSN on the deck in accordance with Figure C-3.
7. In accordance with Table One, Line 3, Column B, Abrasive blast the repair area in accordance with paragraph 3.14 and conduct QA checkpoints in accordance with paragraph 3.14. Remove steel masking plates and visually inspect the repair area, including the edge of adjacent, adherent, retained TSN, to verify NACE 1/SSPC-SP 5 of 2.3. Document the results on Repair QA Checklist Form, Appendix B.
8. Install steel masking plates along the repair area for application of the first layer of TSN.

- a. Install steel masking plates to protect the retained TSN edge from TSN installation overspray.
  - b. Place the steel masking plates along the edge of the repair area such that some part of the plate is in direct contact with the deck in accordance with Figure C-2. Align steel masking plates to extend 1/8 inch beyond the retained TSN edge to create a “shadow mask” in accordance with Figure C-5. Steel masking plates extending less than 1/16 inch beyond the retained TSN edge or greater than 3/16 inch beyond the retained TSN edge must be re-positioned in accordance with Figure C-5 before TSN hand spray application.
9. In accordance with Table One, Line 3, Column C, accomplish hand spray application of first layer of TSN and QA checkpoints in accordance with paragraph 3.15. Measure the FT of the first layer in accordance with paragraph 3.6 except that three spot measurements must be made for each repair area. Document the results on Repair QA Checklist Form, Appendix B.
10. Install steel masking plates for the second layer of TSN in accordance with Figure C-6.
- a. Install steel masking plates to protect the retained TSN edge from TSN installation overspray.
  - b. Place the steel masking plates along the edge of the repair area such that some part of the plate is in direct contact with the deck in accordance with Figure C-2. Align steel masking plates with the retained TSN edge in accordance with Figure C-3.
11. In accordance with Table One, Line 3, Column D, accomplish hand spray application of second layer of TSN and document QA checkpoints in accordance with paragraph 3.15. Measure the FT of the second layer in accordance with paragraph 3.6 except that three spot measurements must be made for each repair area. Record the FT results on Repair QA Checklist Form, Appendix B.
12. Remove steel masking plates and in accordance with Table One, Line 3, Column E, clean TSN repair area and document cleaning in accordance with paragraph 3.16 on Repair QA Checklist Form, Appendix B.
13. In accordance with Table One, Line 3, Column F, apply sealer to TSN in the repair area in accordance with paragraph 3.17 and document sealing on QA Checklist Form, Appendix 6 of 009-32 of 2.1.
- a. Overlap of sealer onto areas of retained TSN must not exceed 1/2 inch.

14. In accordance with Table One, Line 3, Column G, apply dark gray color top to TSN in the repair area in accordance with paragraph 3.18 and document top coat application on QA Checklist Form, Appendix 6 of 009-32 of 2.1.
  - a. Overlap of dark gray onto areas of retained TSN must not exceed 1/2 inch.
15. In accordance with Table One, Line 3, Column H, apply VLA marking color top to TSN in the repair area in accordance with paragraph 3.19 and document VLA marking color top application on QA Checklist Form, Appendix 6 of 009-32 of 2.1.
  - a. Overlap of VLA Marking colors onto areas of retained TSN must not exceed 1/2 inch.
  - b. Overlap of VLA Marking colors on dark gray color top must not exceed 1/2 inch.
16. Accomplish MIL-PRF-24667 nonskid system application to tie in areas, deck tie-down fittings, areas around recessed flight deck lights, and to areas around other designated deck fittings in accordance with 009-32 of 2.1.

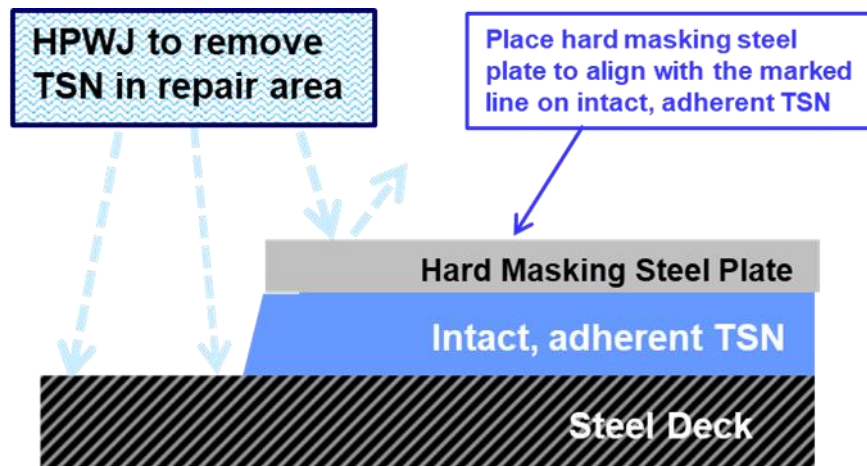

Figure C-1: Cross section view of masking alignment for TSN removal using HP WJ

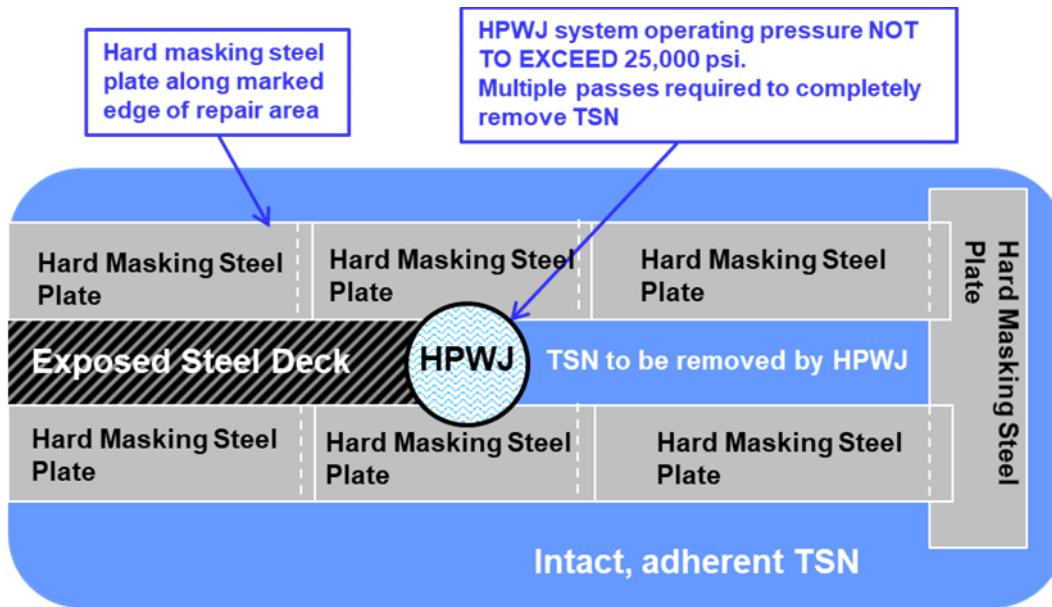

Figure C-2: Example of hard masking plate configuration for HPWJ

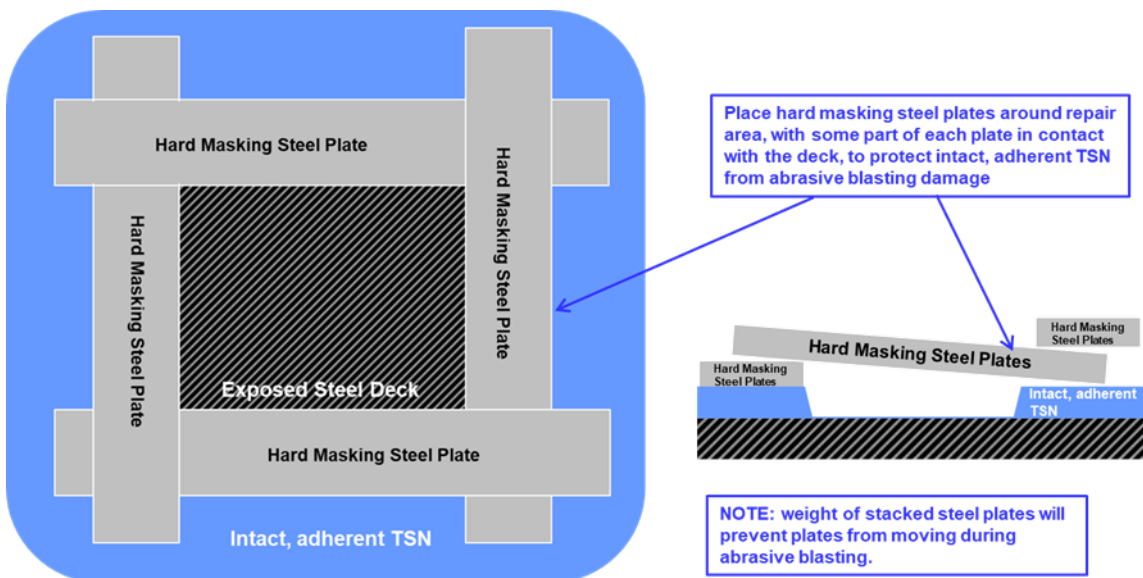

Figure C-3: Example of hard masking plate configuration around repair area



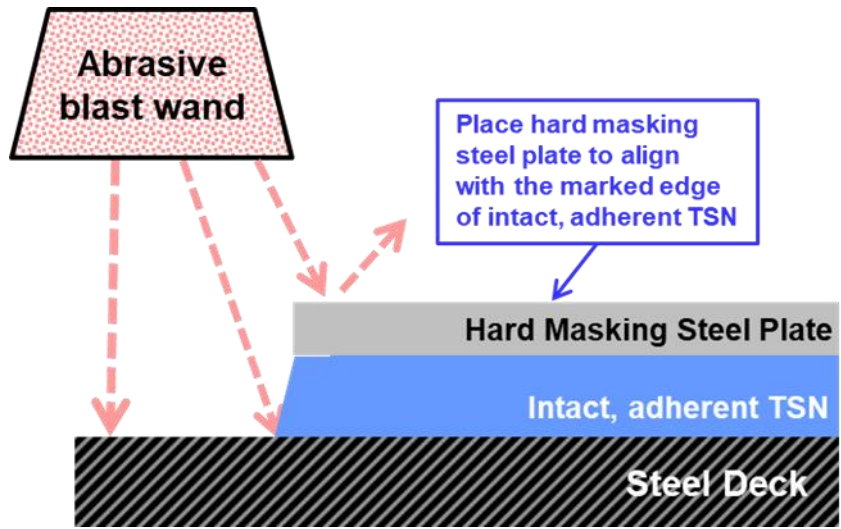

Figure C-4: Cross section view of masking alignment for abrasive blasting after HP WJ removal

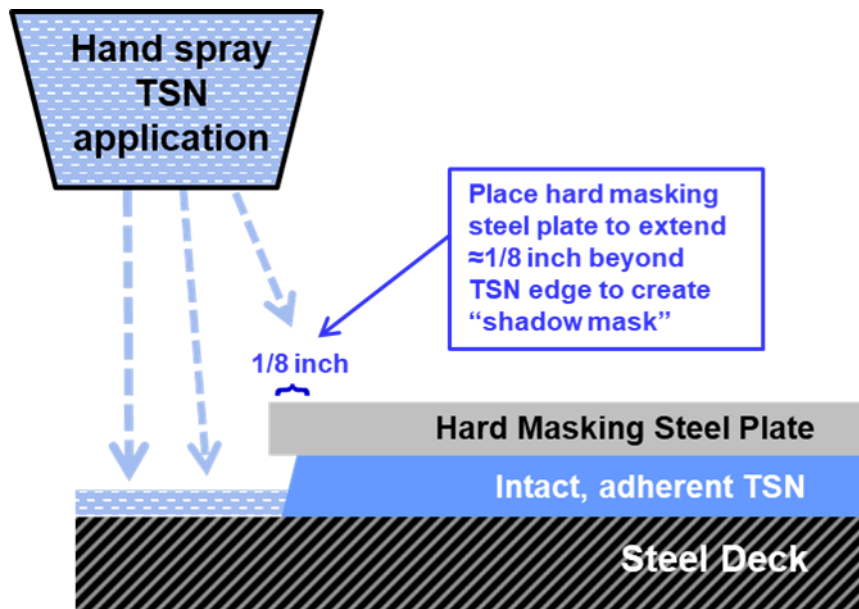

Figure C-5: Cross section view of shadow mask for first layer of TSN

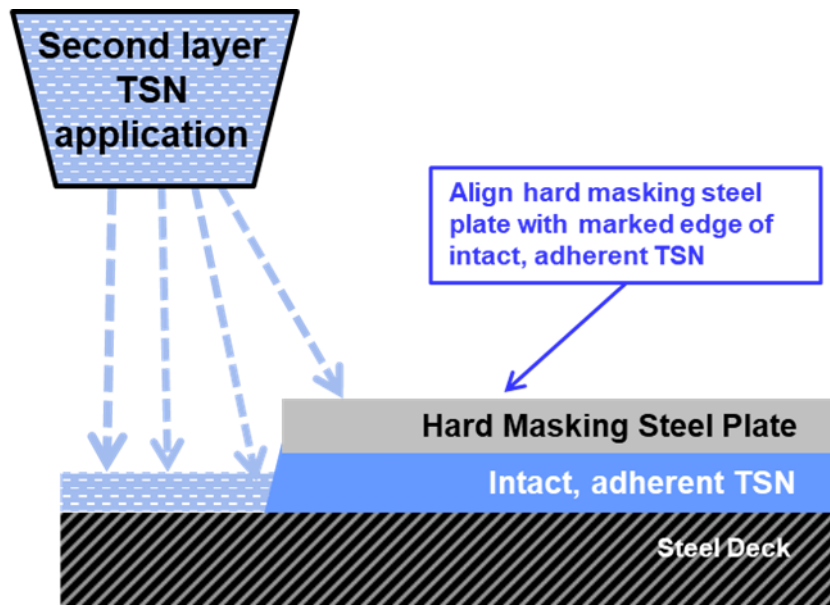

Figure C-6: Cross section view of masking alignment for second layer of TSN

## ATTACHMENT D

### Repair Procedure for Less Than 20 Square Foot Areas of TSN that Requires Removal by Hand and Power Tools and TSN Installation Using TSN Hand Spray Application Equipment

1. The repair areas must be designated and marked by the NAVSEA-approved Technical Representative.
2. As directed by the SUPERVISOR, remove TSN from designated repair areas using rotary cutting tools and hand tools. Hand sand TSN edges around repair areas using 80 – 120 grit paper or equivalent abrasive pad to remove sharp burrs or slivers along the edge of retained TSN.
3. In-process records must be recorded and maintained on Repair QA Checklist Form, Appendix B for each repair area.
4. One legible copy of Repair QA Checklist Form Appendices must be submitted to the SUPERVISOR within 24 hours of completion of TSN removal in each repair location listed in the invoking Work Item or task order.
5. Solvent clean the exposed substrate and retained TSN surfaces surrounding each repair area to an SSPC-SP 1 cleanliness to remove chloride and hydrocarbon contamination. Solvent clean between one and two inches of retained TSN around the entire perimeter of each repair area.
6. Measure and document the conductivity of each repair area in accordance with paragraph 3.13.3 on Repair QA Checklist Form, Appendix B.
7. Verify each repair area is free of contaminants in accordance with paragraph 3.13.4 and document the results on Repair QA Checklist Form, Appendix B.
8. Install steel masking plates around the edges of the repair area in accordance with Figures D-1 and D-2. The masking plates must be between 1/16-inch and 1/8-inch thick, a minimum of 6 inches wide, and placed along the edge of the repair in a manner such that some part of the plate is in direct contact with the deck in accordance with Figure D-2.
  - a. Steel masking plates must be aligned with the repair edge as shown in Figure D-1.
  - b. In repair areas with edges that are not straight, no more than 1/2 inches of retained TSN must be visible between any hard steel masking plate and the exposed steel in the TSN repair area.
9. Accomplish the QA checkpoints in accordance with 3.13.2, 3.13.3, 3.13.4 and document the results on Repair QA Checklist Form, Appendix B.

10. In accordance with Table One, Line 4, Column B, Abrasive blast the repair area in accordance with paragraph 3.14 and conduct QA checkpoints in accordance with paragraph 3.14. Remove steel masking plates and visually inspect the repair area, including the edge of adjacent, adherent, retained TSN, to verify NACE 1/SSPC-SP 5 of 2.3. Document the results on Repair QA Checklist Form, Appendix B.
11. Install steel masking plates along the repair area for application of the first layer of TSN.
  - a. Install steel masking plates to protect the retained TSN edge from TSN installation overspray.
  - b. Place the steel masking plates along the edge of the repair area such that some part of the plate is in direct contact with the deck in accordance with Figure D-2. Align steel masking plates to extend 1/8 inch beyond the retained TSN edge to create a “shadow mask” in accordance with Figure D-3. Steel masking plates extending less than 1/16 inch beyond the retained TSN edge or greater than 3/16 inch beyond the retained TSN edge must be re-positioned in accordance with Figure D-3 before TSN spray application.
12. In accordance with Table One, Line 4, Column C, accomplish hand spray application of first layer of TSN and QA checkpoints in accordance with paragraph 3.15. Measure the FT of the first layer in accordance with paragraph 3.6 except that three spot measurements must be made for each repair area. Document the results on Repair QA Checklist Form, Appendix B.
13. Install steel masking plates for the second layer of TSN in accordance with Figure D-4.
  - a. Install steel masking plates to protect the retained TSN edge from TSN installation overspray.
  - b. Place the steel masking plates along the edge of the repair area such that some part of the plate is in direct contact with the deck in accordance with Figure D-2. Align steel masking plates with the retained TSN edge in accordance with Figure D-4.
14. In accordance with Table One, Line 3, Column D, accomplish hand spray application of second layer of TSN and document QA checkpoints in accordance with paragraph 3.15. Measure the FT of the second layer in accordance with paragraph 3.6 except that three spot measurements must be made for each repair area. Record the FT results on Repair QA Checklist Form, Appendix B.
15. Remove steel masking plates and in accordance with Table One. Line 3, Column E, clean TSN repair area and document cleaning in accordance with paragraph 3.16 on Repair QA Checklist Form, Appendix B.

16. In accordance with Table One, Line 3, Column F, apply sealer to TSN in the repair area in accordance with paragraph 3.17 and document sealing on QA Checklist Form, Appendix 6 of 009-32 of 2.1.
  - a. Overlap of sealer onto areas of retained TSN must not exceed 1/2 inch.
  
17. In accordance with Table One, Line 3, Column G, apply dark gray color top to TSN in the repair area in accordance with paragraph 3.18 and document top coat application on QA Checklist Form, Appendix 6 of 009-32 of 2.1.
  - a. Overlap of dark gray onto areas of retained TSN must not exceed 1/2 inch.
  
18. In accordance with Table One, Line 3, Column H, apply VLA marking color top to TSN in the repair area in accordance with paragraph 3.19 and document VLA marking color top application on QA Checklist Form, Appendix 6 of 009-32 of 2.1.
  - a. Overlap of VLA Marking colors onto areas of retained TSN must not exceed 1/2 inch.
  - b. Overlap of VLA Marking colors on dark gray color top must not exceed 1/2 inch.
  
19. Accomplish MIL-PRF-24667 nonskid system application to tie in areas, deck tie-down fittings, areas around recessed flight deck lights, and to areas around other designated deck fittings in accordance with 009-32 of 2.1.

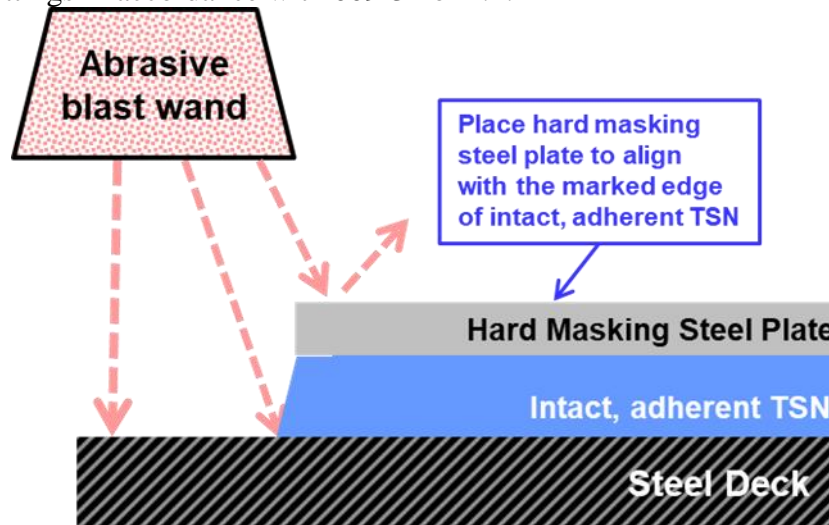

Figure D-1: Cross section view of masking alignment for abrasive blasting

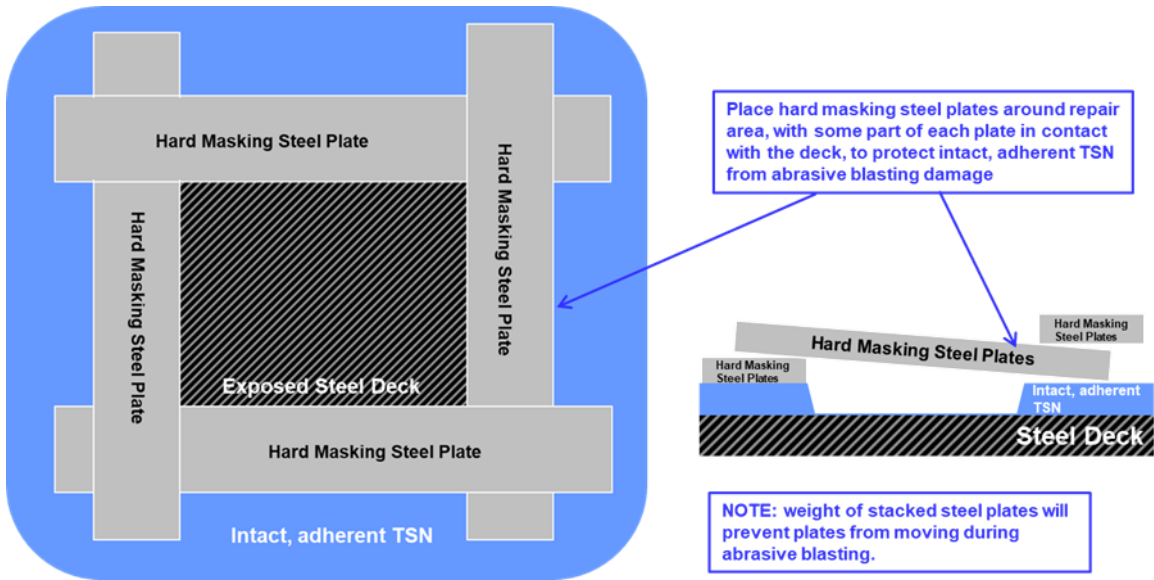

Figure D-2: Example of hard masking plate configuration around repair area

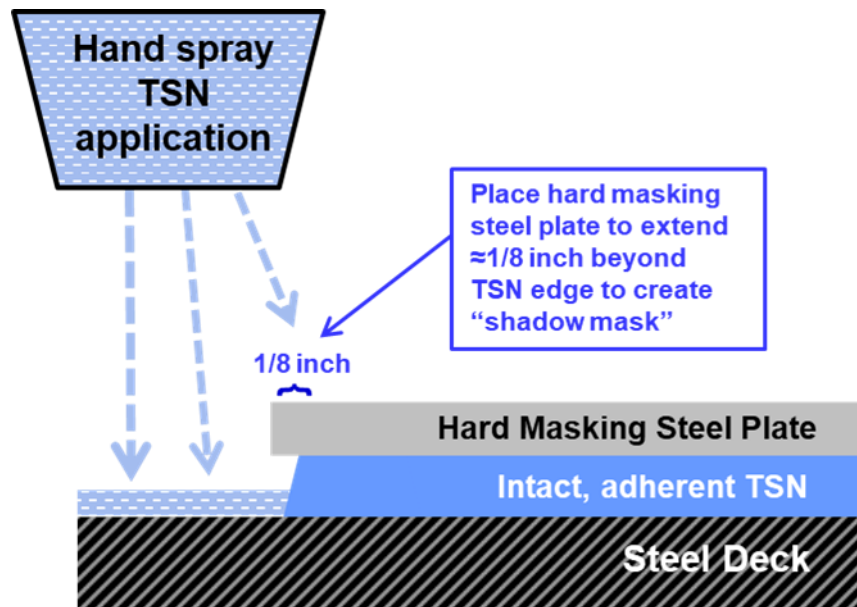

Figure D-3: Cross section view of shadow mask for first layer of TSN

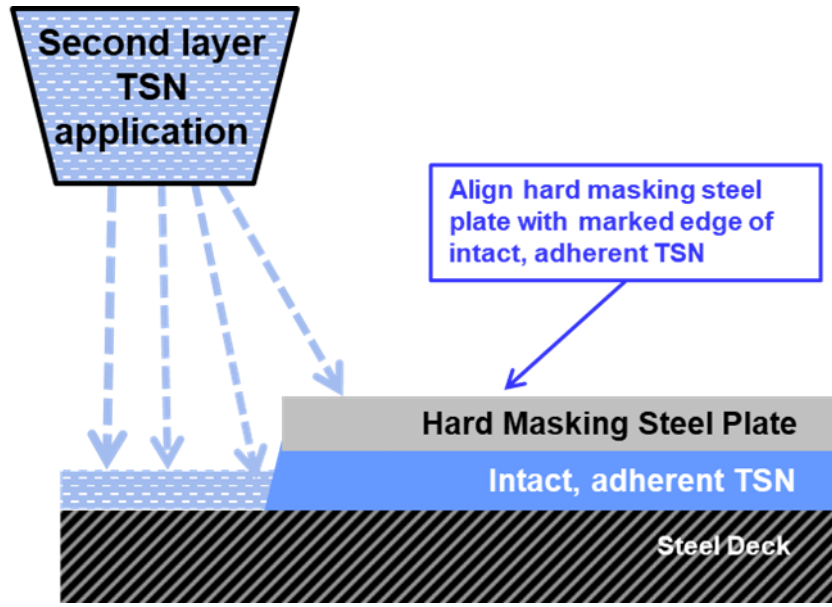
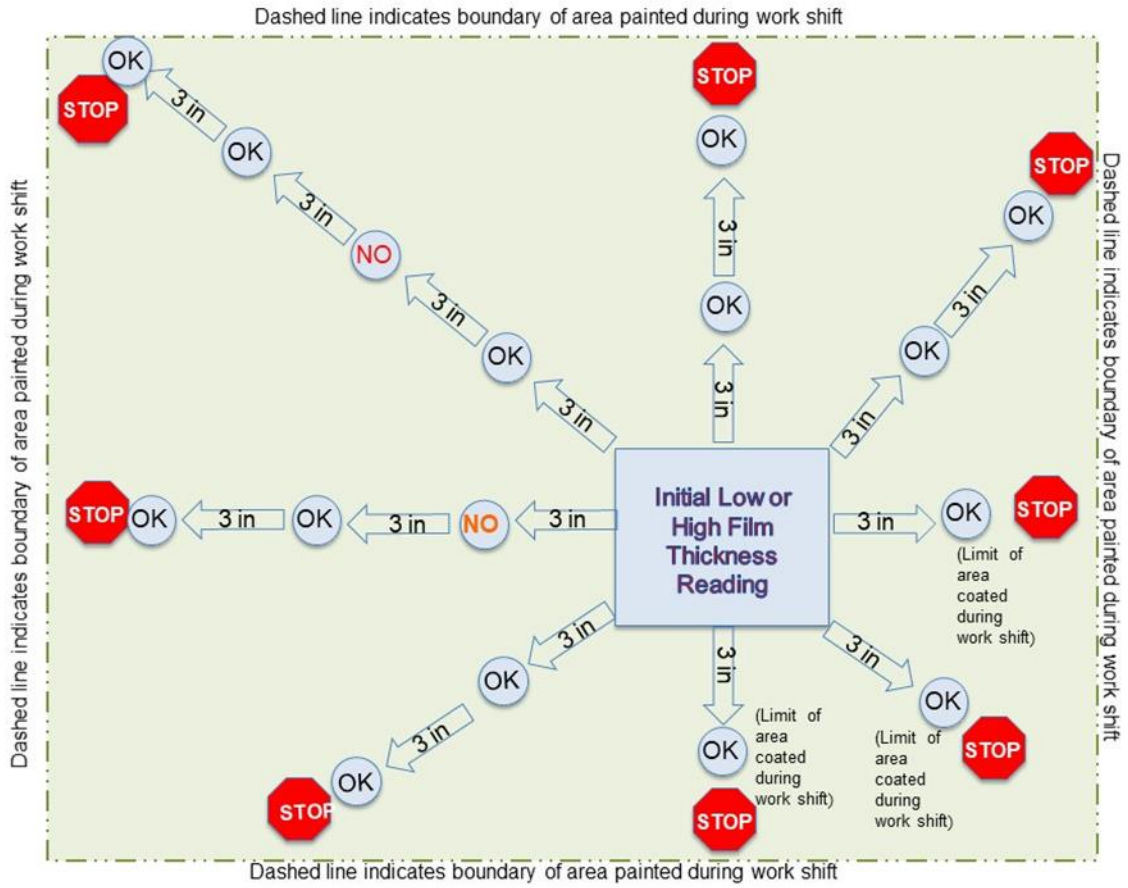

Figure D-4: Cross section view of masking alignment for second layer of TSN

ATTACHMENT E

Determination of Boundary Area with Low or High Film Thickness





## NOTES FOR TABLE ONE

1. The specific areas to be repaired must be defined and marked by the SUPERVISOR.
2. Refer to Attachment B for repair procedures of areas greater than 200 square feet.
3. Apply sealer to TSN in repair areas. Overlap of sealer onto surrounding TSN color topping must not exceed 1/2 inch.
4. Refer to Attachment C for repair procedures for areas between 20 – and 200 square feet.
5. The specific areas to be repaired must be defined, marked, and excavated for surface preparation by the NAVSEA-approved Technical Representative. Delaminated areas of TSN must be identified by the NAVSEA-approved Technical Representative and removed from the deck using rotary cutting tools, chisels, and hammers.
6. Refer to Attachment D for repair procedures of areas less than 20 square feet.

TABLE ONE: SURFACE PREPARATION AND COATING SYSTEM

TABLE ONE STEEL SURFACES	LINE	A PRIMARY SURFACE PREPARATION	B SECONDARY SURFACE PREPARATION	C TSN FIRST LAYER	D TSN SECOND LAYER	E SURFACE CLEANING	F TSN COLOR TOP SYSTEM  SEALER	G TSN COLOR TOP SYSTEM  TOP COAT	H VLA MARKING
FLIGHT DECKS - NEW INSTALL IN WORK ZONE	1	WATERJET TO NACE/SSPC-SP WJ-2/L	WHITE METAL BLAST TO NACE 1/SSPC-SP 5, 4-10 MIL PROFILE	MIL-PRF-32577 IN ACCORDANCE WITH 2.2,  FIRST LAYER 25 MIL FT MINIMUM	MIL-PRF-32577 IN ACCORDANCE WITH 2.2,  TOTAL SYSTEM 45 MIL FT MINIMUM	BRUSH/BROOM OR WATER CLEANING IN ACCORDANCE WITH 3.16	APPLY SEALER AND BACK ROLL IN ACCORDANCE WITH ASTM F718	FIRST COAT DECK GRAY 2-3 MILS WFT  IF REQUIRED FOR HIDING, ONE ADDITIONAL COAT MUST BE APPLIED	FIRST COAT 2-3 MILS WFT  IF REQUIRED FOR HIDING, ONE ADDITIONAL COAT MUST BE APPLIED

<p>FLIGHT DECKS - REPAIR OF INSTALLED TSN BY HP WJ AND TSN ROBOTIC SPRAY EQUIPMENT AREAS GREATER THAN 200 SQUARE FEET SEE NOTES (1) &amp; (2)</p>	<p>2</p>	<p>WATERJET TO NACE/SSPC-SP WJ-2/L</p>	<p>WHITE METAL BLAST TO NACE 1/SSPC-SP 5, 4-10 MIL PROFILE</p>	<p>MIL-PRF-32577 IN ACCORDANCE WITH 2.2, FIRST LAYER 25 MIL FT MINIMUM</p>	<p>MIL-PRF-32577 IN ACCORDANCE WITH 2.2, TOTAL SYSTEM 45 MIL FT MINIMUM</p>	<p>BRUSH/BROOM OR WATER CLEANING IN ACCORDANCE WITH 3.16</p>	<p>APPLY SEALER AND BACK ROLL IN ACCORDANCE WITH ASTM F718 SEE NOTE (3)</p>	<p>FIRST COAT DECK GRAY 2-3 MILS WFT IF REQUIRED FOR HIDING, ONE ADDITIONAL COAT MUST BE APPLIED</p>	<p>FIRST COAT 2-3 MILS WFT IF REQUIRED FOR HIDING, ONE ADDITIONAL COAT MUST BE APPLIED</p>
<p>FLIGHT DECKS- REPAIR OF INSTALLED TSN BY HP WJ AND TSN HAND SPRAY EQUIPMENT AREAS BETWEEN 20 SQUARE FEET AND 200 SQUARE FEET SEE NOTE (1)&amp;(4)</p>	<p>3</p>	<p>SAME AS LINE 1</p>	<p>SAME AS LINE 1</p>	<p>SAME AS LINE 1</p>	<p>MIL-PRF-32577 IN ACCORDANCE WITH 2.2, TOTAL SYSTEM 45 MIL FT <b>MINIMUM</b></p>	<p>SAME AS LINE 1</p>	<p>SAME AS LINE 1</p>	<p>SAME AS LINE 1</p>	<p>SAME AS LINE 1</p>

FLIGHT DECKS -  REPAIR OF INSTALLED TSN BY HAND AND POWER TOOLS AND TSN HAND SPRAY EQUIPMENT  AREAS LESS THAN 20 SQUARE FEET  SEE NOTES (5) & (6)	4	SSPC-SP 1	SAME AS LINE 1	SAME AS LINE 1	SAME AS LINE 3	SAME AS LINE 1	SAME AS LINE 1	SAME AS LINE 1	SAME AS LINE 1
---	---	-----------	----------------	----------------	----------------	----------------	----------------	----------------	----------------

Appendix A - Thermal Spray QA Checklist Form

Ship Name & Hull #:	Contract/Task Order/CLIN/TWD:			
Date:	Work Item: _____ Para. No. _____			
Product being Applied:	Location / Size (FT <sup>2</sup> ) _____			
Req't Document: _____/FY: _____ Table: _____ Line: _____ Column: _____				
MAINTAIN SEPARATE LOG FOR EACH AREA/LOCATION PREPARED AND COATED DAILY. WHEN AN AREA IS DIVIDED INTO SEPARATE SECTION, MAINTAIN A SEPARATE LOG FOR EACH SECTION				
NOTE #1: For any UNSAT condition found, provide the technical adjudication and correct action taken in the comments block.				
NOTE #2 If spaces are not applicable, insert N/A. Unused sections must be crossed out and marked N/A				
(V) Primary Surface Preparation (NACE SSPC-SP WJ2/L);	Visual	SAT: <input type="checkbox"/>	UNSAT: <input type="checkbox"/>	
Contractor (Print): _____ (Signature): _____ Date/Time: _____				
(I) (G) Conductivity: (<30µs/cm) One for first 200 ft <sup>2</sup> - One for each additional 400 ft <sup>2</sup>	#	Conductivity (µs/cm)	SAT	UNSAT
	1			
	2			
	3			
	4			
	5			
Condition of Checkpoint SAT: <input type="checkbox"/> UNSAT: <input type="checkbox"/>				
Contractor (Print): _____ (Signature): _____ Date/ Time: _____				
Subcontractor (Print): _____ (Signature): _____ Date/Time: _____				
Gov't Insp. (Print): _____ (Signature): _____ Date/Time: _____				
(I) (G) Cleanliness Prior to Abrasive Blasting (SSPC-SP 1)	Visual	SAT: <input type="checkbox"/>	UNSAT: <input type="checkbox"/>	
Water Break Test: Min. one per 200 FT <sup>2</sup>		SAT: <input type="checkbox"/>	UNSAT: <input type="checkbox"/>	
Contractor (Print): _____ (Signature): _____ Date/Time: _____				
Subcontractor (Print): _____ (Signature): _____ Date/Time: _____				
Gov't Insp. (Print): _____ (Signature): _____ Date/Time: _____				
(V) Verify Compressed Air Quality		SAT: <input type="checkbox"/>	UNSAT: <input type="checkbox"/>	

Contractor (Print): \_\_\_\_\_ (Signature): \_\_\_\_\_ Date/Time: \_\_\_\_\_

<u>(I) (G) Secondary Surface Preparation (SSPC-SP 5)</u>	Visual SAT: <input type="checkbox"/> UNSAT: <input type="checkbox"/>
--	--

<u>(I) (G) Surface Profile</u>	SAT: <input type="checkbox"/> UNSAT: <input type="checkbox"/>
--------------------------------	---

<u>Surface Texture: RΔg</u> Minimum .45. One for every 400ft <sup>2</sup> - One measurement = mean of 5 individual readings	<table border="1" style="width: 100%; border-collapse: collapse; text-align: center;"> <thead> <tr> <th>#</th> <th colspan="5">Individual Readings (RΔg)</th> <th>AVG.</th> </tr> </thead> <tbody> <tr><td>1</td><td></td><td></td><td></td><td></td><td></td><td></td></tr> <tr><td>2</td><td></td><td></td><td></td><td></td><td></td><td></td></tr> <tr><td>3</td><td></td><td></td><td></td><td></td><td></td><td></td></tr> <tr><td>4</td><td></td><td></td><td></td><td></td><td></td><td></td></tr> <tr><td>5</td><td></td><td></td><td></td><td></td><td></td><td></td></tr> </tbody> </table>	#	Individual Readings (RΔg)					AVG.	1							2							3							4							5						
#	Individual Readings (RΔg)					AVG.																																					
1																																											
2																																											
3																																											
4																																											
5																																											

<u>Surface Profile: (Method B) 4-10</u> mils. Two for every 100ft <sup>2</sup> . One measurement = mean of 10 individual gage readings. Each avg. recorded.	<table border="1" style="width: 100%; border-collapse: collapse; text-align: center;"> <thead> <tr> <th>#</th> <th colspan="10">Individual Readings (mils)</th> <th>AVG.</th> </tr> </thead> <tbody> <tr><td>1</td><td></td><td></td><td></td><td></td><td></td><td></td><td></td><td></td><td></td><td></td><td></td><td></td></tr> <tr><td>2</td><td></td><td></td><td></td><td></td><td></td><td></td><td></td><td></td><td></td><td></td><td></td><td></td></tr> <tr><td>3</td><td></td><td></td><td></td><td></td><td></td><td></td><td></td><td></td><td></td><td></td><td></td><td></td></tr> <tr><td>4</td><td></td><td></td><td></td><td></td><td></td><td></td><td></td><td></td><td></td><td></td><td></td><td></td></tr> <tr><td>5</td><td></td><td></td><td></td><td></td><td></td><td></td><td></td><td></td><td></td><td></td><td></td><td></td></tr> </tbody> </table>	#	Individual Readings (mils)										AVG.	1													2													3													4													5												
#	Individual Readings (mils)										AVG.																																																																			
1																																																																														
2																																																																														
3																																																																														
4																																																																														
5																																																																														

Contractor (Print): \_\_\_\_\_ (Signature): \_\_\_\_\_ Date/Time: \_\_\_\_\_

Subcontractor (Print): \_\_\_\_\_ (Signature): \_\_\_\_\_ Date/ Time: \_\_\_\_\_

Gov't Insp. (Print): \_\_\_\_\_ (Signature): \_\_\_\_\_ Date/Time: \_\_\_\_\_

NOTES:

<u>(I) (G) Dust Tape:</u> Three for each 400ft <sup>2</sup> . Minimum Rating 2 / Class 2. Attach specimens to the backside of this form.	<table border="1" style="width: 100%; border-collapse: collapse;"> <tr> <th colspan="3">Adhesive Tape Type</th> </tr> <tr> <th>#</th> <td></td> <td></td> </tr> <tr><td>1</td><td></td><td></td></tr> <tr><td>2</td><td></td><td></td></tr> <tr><td>3</td><td></td><td></td></tr> <tr><td>4</td><td></td><td></td></tr> <tr><td>5</td><td></td><td></td></tr> </table> <div style="margin-left: 20px;">           Condition of Checkpoint            SAT: <input type="checkbox"/>      UNSAT: <input type="checkbox"/> </div>	Adhesive Tape Type			#			1			2			3			4			5		
Adhesive Tape Type																						
#																						
1																						
2																						
3																						
4																						
5																						

Contractor (Print): \_\_\_\_\_ (Signature): \_\_\_\_\_ Date/Time: \_\_\_\_\_

Subcontractor (Print): \_\_\_\_\_ (Signature): \_\_\_\_\_ Date/ Time: \_\_\_\_\_

Gov't Insp. (Print): \_\_\_\_\_ (Signature): \_\_\_\_\_ Date/Time: \_\_\_\_\_

(V) Verify Secondary Surface Preparation Prior to TSN Application	Visual      SAT: <input type="checkbox"/> UNSAT: <input type="checkbox"/>																				
Contractor(Print): _____ (Signature): _____ Date/Time: _____																					
(V) Thermal Spray Application Machine Settings: Verify machine settings are in accordance with qualified procedure in 2.2	SAT: <input type="checkbox"/> UNSAT: <input type="checkbox"/>																				
Start and Stop Times (each layer)	<table border="1" style="width:100%; border-collapse: collapse;"> <tr> <td style="width:50%; padding: 2px;">Start/Stop First Layer</td> <td style="width:50%; padding: 2px;">Start/Stop Second Layer</td> </tr> <tr> <td style="height: 20px;"></td> <td></td> </tr> <tr> <td style="height: 20px;"></td> <td></td> </tr> </table>	Start/Stop First Layer	Start/Stop Second Layer																		
Start/Stop First Layer	Start/Stop Second Layer																				
Product Information	Manufacturer: _____ Batch Number(s) _____ Expiration Date(s): _____																				
Contractor(Print): _____ (Signature): _____ Date/Time: _____																					
(V) Mandrel Bend Witness <u>Coupons</u> : Three for the total area coated	<table border="1" style="width:100%; border-collapse: collapse;"> <thead> <tr> <th style="width:12.5%;">Coupon #</th> <th style="width:12.5%;">Profile</th> <th style="width:12.5%;">FT</th> <th style="width:12.5%;">Bend SAT</th> <th style="width:12.5%;">Bend UNSAT</th> </tr> </thead> <tbody> <tr><td style="height: 20px;"></td><td></td><td></td><td></td><td></td></tr> <tr><td style="height: 20px;"></td><td></td><td></td><td></td><td></td></tr> <tr><td style="height: 20px;"></td><td></td><td></td><td></td><td></td></tr> </tbody> </table>	Coupon #	Profile	FT	Bend SAT	Bend UNSAT															
Coupon #	Profile	FT	Bend SAT	Bend UNSAT																	
Contractor (Print): _____ (Signature): _____ Date/Time: _____																					
(V) Thermal Spray Visual Inspection (no cracks, delamination, irregularities)	SAT: <input type="checkbox"/> UNSAT: <input type="checkbox"/>																				
Contractor(Print): _____ (Signature): _____ Date/Time: _____																					







Appendix B - Thermal Spray Repair QA Checklist Form

Ship/Hull No.:				
ITEM NO:		Date:		
Location:		Repair Area No.:		Dimensions:
<b>Environmental</b>				
Substrate (F°)	Humidity (%)	Ambient (F°)	Dew Point (F°)	
<b>Surface Cleanliness - Conductivity</b>				
Water Break tests must be performed on any spots that visually indicate hydrocarbon contamination.				
Conductivity: Take one conductivity measurement for every area that is planned to be blasted for the same production day. Conductivity readings must not exceed 30 micro-siemens/cm.				
Time	Conductivity Reading (μS/cm)	SSPC-SP 1/Water Break		
Indicate and Verify Primary Surface Preparation: WJ-2 (22,000 – 25,000 PSI) / Power and Hand Tool Results of TSN Removal: SAT / UNSAT Compressed Air Quality (Blotter Test): SAT / UNSAT Inspect surface for SSPC-SP 5 conformance.: SAT / UNSAT				
<b>Surface Profiles</b>				
Reading	ASTM D4417 Method B	Stylus Profilometer		
	4.0-10 Mil Height (mil)	>0.45 RΔq		
1				
2				
3				
4				
5				
Avg				
Dust Test: SAT / UNSAT Machine Settings: SAT / UNSAT Mandrel Bend Test: SAT / UNSAT FT and Results: SAT / UNSAT				Notes:

Contractor(Print): _____	(Signature): _____	Date: _____
Subcontractor(Print): _____	(Signature): _____	Date: _____
Gov't Insp.(Print): _____	(Signature): _____	Date: _____

NAVSEA  
STANDARD ITEM

FY-24

ITEM NO: 009-125

DATE: 25 OCT 2022

CATEGORY: I

1. SCOPE:

1.1 Title: Boats Less Than 65 Feet Long; accomplish

2. REFERENCES:

2.1 Standard Items

2.2 S9086-TX-STM-010 /CH-583, Boats and Small Craft

2.3 American Boat and Yacht Council (ABYC) Standards

2.4 29 CFR Part 1915, Occupational Safety and Health Standards for Shipyard  
Employment

2.5 UL1426, Underwriters Laboratories (UL) Standard for Electrical Cables for Boats

2.6 IEEE 1580, Recommended Practice for Marine Cable for Use on Shipboard and  
Fixed or Floating Facilities

2.7 S9086-CJ-STM-010 /CH-075, Fasteners

2.8 ASTM B33, Standard Specification for Tin-Coated Soft or Annealed Copper Wire  
for Electrical Purposes

2.9 S9086-RK-STM-010/CH-505, Piping Systems

2.10 NAVSEA Drawing 53711-300-5107858 Standard Electrical Installation  
Requirements and Nomenclature

3. REQUIREMENTS:

3.1 Accomplish General Criteria

3.1.1 Reference 2.2 and 2.3 must be accomplished unless otherwise specified in  
Work Item with the following exceptions in 3.1 through 3.10.

3.1.2 Accomplish each (I), (V) and (Q) test/inspection that does not have an associated (G)-point, with qualified and/or currently certified personnel where required by each technical document (e.g., NAVSEA Basic Paint Inspector (NBPI), Association for Materials Protection and Performance (AMPP), nondestructive testing, electrical cableway inspection, Oxygen Cleanliness Inspector, etc.) as follows:

3.1.2.1 Each (I) inspection requires verification and documentation by a separate individual, other than the person who has accomplished the work, who is qualified as an inspector.

3.1.2.2 Each (V) inspection requires verification and documentation by the qualified tradesperson, trade supervisor, or inspector.

3.1.2.3 Each (Q) inspection requires verification and documentation by a qualified Technical Representative in accordance with 009-90 of 2.1 and associated PCP requirements.

3.1.2.4 The authority to accomplish, document, accept and reject each (I) and (V) inspection may be delegated to qualified subcontractor personnel, without regards to geographical location, subject to SUPERVISOR approval.

3.1.3 Protect the boat and its equipment from damage.

3.2 Accomplish (G)-Point (government notification) as follows:

3.2.1 (G) is a symbol inserted in a Work Item to establish a point in the sequence of accomplishment of work at which time the SUPERVISOR must be notified by the prime contractor in each case to permit observation of a specific test or inspection (I)(V) by the government. When the symbol (G) precedes each test or inspection in a Work Item which are applicable to more than one action, the symbol (G) must identify the action required, e.g., (G) "HYDROSTATIC TEST". When more than one unit is involved, the (G) notification requirement applies to each unit.

3.2.2 Notify the SUPERVISOR's designated representative by FAX, hard copy, or by electronic method.

3.2.2.1 Notify the SUPERVISOR prior to commencing each specific requirement in a paragraph annotated with the symbol (G), during each normal day shift working hour with at least 4 hours. Following the required notification, each requirement in the paragraph annotated with the symbol (G) may proceed prior to the scheduled time as approved by the SUPERVISOR. Notify the SUPERVISOR to cancel a scheduled test or inspection no later than 2 hours prior to the scheduled event or as negotiated with the SUPERVISOR.

3.2.2.2 Notify the SUPERVISOR not later than 6 hours before the end of the last preceding normal work day when each test or inspection following a (G) Point is scheduled after normal day shift working hour, on a weekend, or on a federal holiday. Following

the required notification, each requirement in the paragraph annotated with the symbol (G) may proceed prior to the scheduled time as approved by the SUPERVISOR. Notify the SUPERVISOR to cancel a scheduled test or inspection as soon as known, but no later than 2 hour prior to the scheduled event.

3.2.2.3 Notify the SUPERVISOR at least 48 hours, prior to commencing each (G)-Point at contractor/subcontractor plant located in excess of 50 miles by the most direct roadway nearest to the place of performance of the contract. Document the date, time, and identification of the SUPERVISOR's representative notified. Following the required notification, each requirement in the paragraph annotated with the symbol (G) may proceed prior to the scheduled time as approved by the SUPERVISOR. Notify the SUPERVISOR to cancel a scheduled test or inspection as soon as known, but no later than 4 hour prior to the scheduled event.

3.2.2.4 Proceed with the test or inspection if the SUPERVISOR is not present, provided the required advance notice has been furnished to the SUPERVISOR and the contractor has completed and documented each preceding test and inspection.

3.2.3 A partial test or inspection requiring (G) notification may be accomplished in the event that work cannot be completed and work progress would be delayed in waiting for total completion of work. Notify SUPERVISOR when the incomplete work is completed and ready for the remainder of the test or inspection. Note each partial inspection on the test or inspection form.

3.2.4 A qualified contractor representative must be present to accomplish, accept or reject and document each test or inspection associated with the symbol (G).

3.2.5 The authority to witness or perform, document and accept/reject (I)(G), (Q)(G), and (V)(G) test and inspection is a prime contractor's responsibility but, subject to SUPERVISOR approval within a 50-mile radius of the contractor's plant nearest to the place of performance of the contract, may be delegated to each subcontractor who are Master Ship Repair Agreement (MSRA) or Agreement for Boat Repair (ABR) agreement holders, SSPC-QP 1, Quality Procedure (QP) One certified, NDT certified, or have a current Quality Management System (QMS) accepted by the SUPERVISOR.

3.2.6 The contractor may delegate responsibility to each subcontractor to perform, document and accept/reject each (I)(G) and (V)(G) test and inspection performed at each plant located outside a 50-mile radius of the contractor's plant nearest to the place of performance of the contract subject to SUPERVISOR prior approval.

3.2.7 Each associated (G)-Point notification requirement must not be delegated.

### 3.3 Reporting Requirements:

3.3.1 Reports must contain the following information:

3.3.1.1 A description of the conditions found with supporting data. Include annotated sketches, graphs, and photographs when necessary to make a report clearly understood to the SUPERVISOR. Identify actual readings and dimensions taken.

3.3.1.2 Recommendations and/or a list of material required.

3.3.1.3 For those reports not submitted in NMD, submit the following additional information: data required by, signature, printed name and title of the contractor's representative, and submission date.

3.3.2 When a Work Item does not require a report, and one is determined to be necessary in order to produce a reliable or complete repair, submit one legible copy, in approved transferrable media, of a report with supporting data as early as possible in the contract period. The goal is to have required work completed within the original contract period.

3.3.3 For each report required by 2.1 or the Work Item, that could result in a change in work to be accomplished or additional material to be procured, complete the preliminary work and submit one legible copy, in approved transferrable media, of the report in a time frame to allow the SUPERVISOR to initiate early action, but no later than the first 20 percent or 30 days of the availability whichever occurs first.

3.3.4 Each report is costly to generate and process. Identify each suspected duplicative reporting requirement and case where each required report could be combined in order to eliminate a report to the SUPERVISOR via e-mail. Receipt of this notification by the SUPERVISOR is not to be construed as a waiver of each reporting requirement unless the SUPERVISOR's response eliminates the required report.

3.3.5 Submit one legible copy, in approved transferrable media, of the following, the report may be waived by the SUPERVISOR one day prior to the weekly progress meeting:

3.3.5.1 A report listing Government Furnished Material not received, showing the associated Work Item number and title, material description, expected delivery date, required delivery date and effect on each production date. Each material with expected delivery date before the required delivery date need not be listed in this report.

3.3.5.2 A report, listing Contractor Furnished Material (CFM) required to accomplish the work in each Work Item that has an estimated delivery date of greater than 30 days or is not already on hand with estimated delivery date that would impact completion of Work Item as scheduled.

3.3.5.3 A report listing late or deficient Government Furnished Information, showing the associated Work Item number and deficiency description.

3.3.5.4 A report of each overdue contractor condition report by Work Item number and expected submission date. The report must also include each deficiency and condition report for which Government response is outstanding.

3.3.5.5 For reports required by 2.1 or the Work Item, that could result in a change in work to be accomplished or additional material to be procured, complete the preliminary work and submit one legible copy, in approved transferrable media, of the report in a time frame to allow the SUPERVISOR to initiate early action. Submission of each report must be no later than first 20 percent or 30 days of the availability whichever occurs first.

3.3.5.6 Any exceptions for submission of a report after the first 20 percent or 30 days of the availability of the availability must be approved by the SUPERVISOR.

3.3.6 When a report is required to be submitted but no time requirement is specified in the Standard Item or Work Item, it must be submitted no later than 4 days after completion of the event.

3.3.7 Provide labor, material, equipment, and each service (such as air, power, water, etc.) which is required to complete the Work Item, including that which is indicated on each drawing or test specification as being provided by each source other than the contractor, unless specifically listed as Government Furnished Material (GFM)

3.3.7.1 When a performance specification (such as MIL-PRF) is specified, each product approved to that specification are those listed on the Government Qualified Products Database (QPD) for that performance specification. If a Type, Class, Grade or other subcategory is listed, each product approved for use are limited to those that meet that subcategory on the performance specification's QPD.

3.3.8 Procure each unclassified Military Specification and Standard and Commercial Specification and Standard referenced in each Work Item. Each classified Military Specification is available at the office of the SUPERVISOR.

3.3.8.1 Each Work Item will normally reference each basic Government Specification, or Standard, without each suffix letter or number which identify revision or amendment. Unless otherwise specified, the effective issue of each basic referenced document, including each revision or amendment, must be the most recent issue at the date of solicitation for a Job Order. Wherever each specific date for specification, standard, and publication or amendment, revision, or alteration thereto are specified in the each Work Item, issues of those dates specifically must apply in lieu of any other issue. Where each industry standard such as American Society for Testing and Materials (ASTM) and American National Standards Institute (ANSI) are referenced, the issue or revision in effect on the date specified for Work Package Solicitations applies.

3.3.8.2 Each Work Item may reference specific revision level of equipment technical manual or drawing. When each reference is listed in a Work Item without a suffix letter or number which identifies revision, change notice, or amendment, unless otherwise



specified, the effective issue of each technical manual, including revision, change notice, or amendment, must be the most recent issue at the date of solicitation for the Job Order.

3.3.9 Submit each request for deviation to the SUPERVISOR.

3.3.9.1 A deviation is defined as any action which is not in conformance with each Work Item requirement, including reference thereto, no matter how minor.

3.3.9.2 Each deviation from a Work Item and each reference thereto will not be considered by the SUPERVISOR without a written request from the contractor.

3.3.9.3 Submit one legible copy, in approved transferrable media, of each request for deviation to the SUPERVISOR within one day of identifying the deviation.

3.3.10 Correct each error in record keeping by drawing a single line through the error, recording the correct entry, initialing, dating, and printing the name of the person making the correction. Each correction to a record must be made by the individual that made the original entry and signed for the accuracy and validity of the record, or by cognizant trade manager or project superintendent.

3.3.11 Record and Certification Signature Block or signature must be legible and in ink. Each erasure, write-over, white-out, ditto mark, continuation arrow, signature stamp, etc., is not acceptable.

3.3.11.1 Each electronic record must utilize an electronic signature control for certification of individual providing signature.

3.4 Respond in writing to each SUPERVISOR issued Method B/C/D Corrective Action (CA) within 3 business days unless otherwise specified by the SUPERVISOR. Initial response must include immediate corrective action taken and a plan of action for CA completion, including estimated completion dates. Final response must include preventive action for recurrence of identified nonconformance, root cause analysis and Objective Quality Evidence (OQE) for corrective action completed. All follow up responses must be as specified by the SUPERVISOR.

3.4.1 Inform the SUPERVISOR when corrective actions are complete for each SUPERVISOR issued Method A (CA). Response required within 3 business days unless otherwise specified by the SUPERVISOR. Response must state that the non-conformance has been corrected.

3.5 Develop a Test and Inspection Plan (TIP) incorporating each Work Item in the job order or Statements of Work (SOW). The initial TIP must include all inspections and tests required by the contractor's Quality Assurance or Quality Management Plan as well as by symbols (I) (V) (Q) test/inspections and (G) government notification identified in the Work Item,

and any additional tests and inspections the contractor deems necessary to substantiate product conformance.

3.5.1 Submit the initial copy of the TIP to the SUPERVISOR prior to start of productive work.

3.6 Test and Inspection records must include hull number, Job Order and Work Item number, component identification, accept/reject criteria, date, time, unique identification of test equipment used, and signature of the contractor's authorized representative who witnessed or performed the test or inspection. The signature occurs after the checkpoint is determined to be satisfactory or unsatisfactory and any exceptions are documented. The records must indicate the results of the test and or inspection accomplished.

3.6.1 Test and inspection records must be retained and made available to the SUPERVISOR as part of work completion certification.

3.7 Attend SUPERVISOR conducted fact-finding/investigative meetings when requested by the SUPERVISOR not to exceed 4 hours.

3.8 Conduct Verification of Alteration, Logistics and Technical Data

3.8.1 Submit one legible copy, in approved transferrable media, of each completed Attachment A to the SUPERVISOR and Naval Surface Warfare Center Carderock Division (NSWCCD) for each alteration (Boat Alteration (BOATALT) and Liaison Action Request (LAR)) installed during availability within 5 days of scheduled final government acceptance of boat.

NSWCCD-Detachment Norfolk  
Attn: Code 8326  
2600 Tarawa Ct. Suite 303  
Virginia Beach, VA 23459-3239

3.8.2 Submit each copy of technical manual, Maintenance Index Page (MIP), and Maintenance Requirements Card (MRC) received with GFM and CFM equipment to the SUPERVISOR no later than 5 days after receipt of equipment.

3.9 Removal of Interference

3.9.1 Do not remove component as interference except when the scope of work requires repair to each component of the system or when specified in the Work Item. If there are any questions submit a report to the SUPERVISOR prior to removal.

3.9.2 Submit one legible copy to the SUPERVISOR, in approved transferrable media, of a report listing each component that must be removed as an interference and the work is not required by the Work Item.

3.9.3 Install interferences removed in 3.9.1

3.9.3.1 Accomplish the requirements of 009-32 of 2.1 for each new and disturbed surface.

3.9.3.2 Align and accomplish appropriate strength, tightness, system cleanliness, and operational tests and ensure that the installed interferences perform their normal functions within the system.

3.9.3.3 Identify, disconnect, inspect, and isolate each cable to be pulled back, reused, rerouted, relocated, or repurposed. Record and retain electrical hook-up data.

3.9.3.4 Connect each cable pulled back, reused, rerouted, relocated, or repurposed using retained electrical hook-up data.

3.10 Conduct Authorization & Tag Out

3.10.1 Accomplish each requirement of the contractor's lockout/tags-plus program for each unmanned craft and barge in accordance with 2.4.

3.10.1.1 Submit one legible copy, in hard copy or approved transferrable media, of contractor's lockout/tags-plus program to the SUPERVISOR when requested.

3.10.1.2 Position equipment to achieve required isolation, by de-energizing, draining of the isolated area, and depressurization, and use lockout/tags-plus program when lock-out of each equipment, system, circuit, component, piping, or valve is required in accordance with 2.4.

3.10.1.3 Post each warning sign and barrier and install temporary positive mean to prevent closure or movement of each component that create a safety hazard at each hull and deck opening.

3.10.2 Install each identification tag on each removed piping section, valve, ventilation system, and equipment to indicate company name, boat, hull number, system, and location and Work Item number prior to removal from system. Each tag must endure the repair process, and must stay attached and be readable until the removed piping section, valve, ventilation system, or equipment is installed.

3.10.2.1 Include quantity when each component is grouped/bagged/comingled together in a bucket or any other type of storage having only one identification tag.

3.10.2.2 Ensure Foreign Material Exclusion (FME) is maintained on equipment removed from the boat.

3.10.3 Install and maintain each blank/plug, nut and bolt, painted white for use as FME immediately upon each opening in equipment, valve, and piping system not subject to pressure to prevent entry of foreign material and protect each flange and threaded area. Each existing system fastener used for blanking that will be reused for installation are excluded from the requirement for white color. FME may be used for each system normally under pressure but are tagged-out for maintenance. The use of cloth, polyvinyl sheet, paper, tape, and rubber sheeting as FME is prohibited. Each FME material must be applied with care, without using excessive force, to avoid damage to each surface/component being protected.

3.10.3.1 Each wood product, including damage control (DC) plug is permitted for use as FME external to the boat for each hull penetration. Each wood product, including DC plug, may be used as FME internal to the boat in each piping and ventilation system where permitted explicitly in the applicable Naval Ship's Technical Manual. Each DC plug, wood, or wood product is prohibited for use in each tank/void.

3.10.3.2 Each piping, ventilation, and equipment component designated as scrap prior to removal does not need to be blanked to maintain cleanliness; however, they must be properly marked as scrap material prior to removal. Each precaution must be taken to preclude spillage of each system content.

3.10.3.3 Verify each temporary blank and plug installed in the performance of work under each Work Item have been removed.

3.10.4 Maintain the cleanliness of each new, modified, repaired and disturbed piping system and component. Maintain cleanliness at the following acceptance standard:

3.10.4.1 Cleanliness Level II: Surface must be visually free of grease, oil, flux, scale, dirt, loose particles and any other contamination foreign to the base metal. Tap water residue on each metal and light superficial rust on each carbon steel surface, caused by short time exposure to the atmosphere, are permitted. Light dust on each cleaned surface is not objectionable, provided that the quantity and size of the particle does not adversely affect each system operation.

3.10.4.2 Cleanliness Level III: Surface must be reasonably free of contamination and any remaining residue on the surface does not interfere with each system operation or damage each system component.

(V) "VERIFY CLEANLINESS"

3.10.4.3 Verify that existing cleanliness was maintained.

3.10.4.4 Submit one legible copy, in approved transferrable media, of a report identifying any location where cleanliness has not been maintained and cannot be restored by local cleaning. Include the cause of system contamination and each recommended action for cleanliness recovery. (See Note 4.8)

3.10.5 Install and maintain each blank/plug, nut and bolt, colored white that will be used for hydrostatic testing on each equipment, valve, and piping system to withstand maximum system pressure for system which will serve as the primary or secondary barrier to support hydrostatic testing. Each existing system fastener used for blanking that will be reused for installation are excluded from the requirement for white color. Secure each blank in place with gasket and fastener or weld in place. Ensure welding requirements for each blank meet the same requirement as the piping weld, in accordance with Ref 2.9 (NSTM 505). The use of cloth, polyvinyl sheet, paper, tape, and rubber sheeting as a blank is prohibited. Each DC plug, wood, or wood product is prohibited as a blank on each pressurized system, but may be used on a non-pressurized system to include gravity drain piping.

3.10.5.1 Ensure each pressure blank has a positive mean of attachment for each affixing tag. Each tags must endure the repair process, and must stay attached and be readable until each blank is removed. Include company/contractor name, Work Item number, Contractor blanking/plugging log entry number, along with system/equipment/component name, number, and location.

3.10.5.2 Ensure each blank, plug or cable end protection installed is removed and system/equipment is restored as soon as possible after completion of work. Ensure each tag-out requirement is followed.

### 3.11 Provide Schedule and Report

3.11.1 Develop in Gantt Chart format an Integrated Production Schedule (IPS) for each work package that reflects the manner in which the availability will be accomplished. The IPS must include:

3.11.1.1 Each Work Item listing each start and completion date, and duration.

3.11.1.2 The latest allowable receipt date for contractor and government furnished material (CFM and GFM) to maintain production schedule.

3.11.1.3 Each Key Event and Milestone with appropriate predecessor relationship to each Key Event and Milestone(s) to ensure there is an accurate logical progression through each Work Activity leading to their assigned Key Event and Milestone(s), to ensure the IPS supports accurate prediction of Key Event and Milestone(s) attainment.

3.11.1.4 Critical Path and each Controlling Work Item.

3.11.2 Revise Production Schedule/IPS level weekly to include each addition, deletion, modification, each actual start and finish date, progress, and completion of each Work Item. Progress must be based on degree of completion of physical work or accomplishment of the Work Activity.

3.11.3 Provide cognizant contractor management representation to participate in the weekly progress meeting at the time and location agreed to by the SUPERVISOR for each work package. The representative(s) must be authorized to make each management decision relative to each routine requirement of the Job Order that, in good faith, commit the contractor.

3.11.3.1 Each weekly progress meeting participant must be prepared to address each Critical Path and Controlling Work Item, and offer a reasonable solution to each problem which may have impact on each scheduled Key Event and Milestone or completion date.

3.11.4 Provide cognizant contractor management representation to participate in a review conference to be held at the 25, 50, and the 75 percent point in the availability and a completion conference to be held no later than 15 working days prior to availability completion date to determine the scope of remaining work for each work package.

3.11.4.1 Subject to SUPERVISOR approval, may be held simultaneously with the Weekly Progress Meeting. Each conference will be scheduled at a time and place mutually agreeable to each party.

### 3.12 Install Electrical/Electronic Cable

3.12.1 Accomplish Electrical and Electronic Cable installation in accordance with 2.3 and 2.10 with the following exceptions.

3.12.1.1 Wiring in each enclosure or for starting battery in accordance with 2.5. In each application, the product may be used without an overall jacket.

3.12.1.2 All provided cables shall be commercial low smoke zero halogen (LSZH) marine multi-conductor cable (compliant with 2.6 and accepted by USCG & ABS) with tinned copper conductors per ASTM B-33 flexible stranding (Tricab "BV Series" or equal). Single conductor UL1426 wire (Ancor or equal) may be used in enclosures and for jumper wires. IEEE-45 or Ancor Battery Cable may be used for battery/starting circuits. (See Note 4.17 & 4.18)

3.12.1.3 Wire in accordance with 2.8. that only has insulation over the conductor and not an overall jacket is only allowed within each enclosure for each jumper.

### 3.13 Install Equal Component

3.13.1 Submit one legible copy, in hard copy or approved transferrable media, of a report to the SUPERVISOR for approval in each instance when the contractor desires, to install "an equal component" vice a "specified component" listed in the Work Item. Provide data to compare the equal component to that specified including the following:

3.13.1.1 Each physical dimension

- 3.13.1.2 Bolting pattern required to install the component
- 3.13.1.3 Each power requirement
- 3.13.1.4 Size, location, and each type of miscellaneous service connection
- 3.13.1.5 Each modification required for installation
- 3.13.1.6 Comparison of each characteristic, i.e., each gallon per minute, cubic feet per minute, and temperature range

3.13.2 Submission of each report must be no later than first 20 percent or 30 days of the availability whichever occurs first.

### 3.14 Threaded Fasteners

3.14.1 Remove existing and install new each non-Level I fastener 1/2-inch nominal diameter and smaller with each new fastener of the same material, strength and design;

3.14.2 Each fastener larger than 1/2-inch nominal diameter must be retained for reuse to the maximum extent possible. Reuse each existing fastener if the acceptance criteria of Attachment B and paragraph 075-8.3 of 2.7 are met.

3.14.2.1 Clean each fastener free of foreign matter (including paint).

3.14.2.2 Chase and tap each exposed threaded area.

3.14.2.3 Install each new threaded fastener, washer, and lock washer in place of those found to be missing or defective.

3.14.3 Utilize Attachment B and 2.7 to select each replacement fastener.

3.14.4 Externally threaded fastener installation acceptance criteria unless otherwise specified or approved:

3.14.4.1 The minimum thread protrusion for each male threaded fastener must be one full thread beyond the face of the nut. The maximum thread protrusion for each male threaded fastener is 10 full threads beyond the face of the nut.

3.14.4.2 For each self-locking (plastic insert) nut installation, the minimum thread protrusion for bolt or stud end may be flush with the face of the nut after the threaded fastener(s) have been installed and tightened. The maximum thread protrusion for each self-locking nut must be 5 threads after the threaded fastener(s) have been installed and tightened.

3.14.5 Internally threaded fastener installation acceptance criteria must be in accordance with paragraph 075-7.6 of 2.7.

4. NOTES:

4.1 The term "day" means 24 hours prior to or after the scheduled event. "Business day" is used to indicate Monday through Friday, otherwise "day" means calendar day (Sunday through Saturday).

4.2 Known sources for unclassified military specifications and standards are:

<https://mercury.tdmis.navy.mil>

<https://assist.dla.mil>

<http://quicksearch.dla.mil>

4.3. The term "SUPERVISOR" is defined as the local Government activity responsible for the execution and contract administration of Navy maintenance and modernization work.

4.4. The term "Job Order" is synonymous with the term "Contract", "Task Order" and "Delivery Order".

4.5. The term "approved transferrable media" is the form, system or program for submitting reports required as agreed to by the SUPERVISOR.

4.6. The term "subcontract" means any contract as defined in the FAR, Subpart 2.1, entered into by a subcontractor to furnish supplies or services for performance of a prime contract or a subcontract. It includes but is not limited to purchase orders, and changes and modifications to purchase orders.

4.7. Worksite is defined as within the specific compartment or space where physical productive work is occurring. For work performed on Navy boats and craft or service craft, the "worksite" is defined as on or near the vessel.

4.8. FME is used to maintain system cleanliness. Accomplishment of NSI 009-107 of 2.1, or other means of cleanliness restoration, will be invoked within the Work Item when cleanliness is lost or suspected of being lost.

4.9. Production Schedule: The schedule used by contractor and subcontractor personnel as a means of planning, tracking, and coordinating the accomplishment of contract work.

4.10. Integrated Production Schedule (IPS): A schedule used by the contractor as a means of planning, tracking, coordinating and de-conflicting work during the availability.

4.11. Work Activity: A portion of an individual Work Item, which is a logical subdivision of the Work Item, representing a manageable unit of work, including material procurement which must be accomplished at a specific period of time in relation to other activities of the Job Order.



4.12. Key Event: An event that, if slippage occurs, could impact or delay the overall schedule, or prevent timely delivery of the vessel. Key Events are identified by the contract, the SUPERVISOR, or the contractor.

4.13. Milestone: A significant event identified by the Maintenance Team. Milestones are used as a scheduling aid and establish significant points where progress must be evaluated and confirmed. Accumulated failure to achieve Milestones on schedule may result in missed Key Events. Milestones may be identified by either the contractor or the SUPERVISOR.

4.14. Critical Path: That sequence of Work Activities which forms the work and test chain of the longest duration, and directly affects the completion of the availability. Factors that influence when a Work Activity is on the Critical Path include: time duration required for the Work Activity, space limitations, manpower available, and the predecessor/successor relationships between Work Activities. Typically, the Critical Path is determined by automated schedule analysis and will include any sequential set of Work Activities forming the longest chain of events extending throughout the schedule and which has the least Total Float.

4.15. Controlling Work Items: Those Work Items which include activities that are on the critical path of the IPS, which, by virtue of scope, material requirements, complexity, or other considerations, have the significant potential for impact on the scheduled project Key Events or completion of the availability.

4.16. Total Float: The total number of days that a path of Work Activities can be delayed without affecting the project finish date. A path of Work Activities is established by predecessor and successor relationships.

4.17. Requirements for LSZH cables in Paragraph 3.12.1.2 are not applicable to boats acquired without LSZH cables before 2010.

4.18. Requirement for use of commercial LSZH cables in Paragraph 3.12.1.2 may be superseded if MIL-DTL-24640 or MIL-DTL-24643 are specified in the Task Order.

ATTACHMENT A

BOAT ALTERATION (BOATALT) AND  
LIASON ACTION REPORT (LAR)  
COMPLETION REPORT

REPORT NO: \_\_\_\_\_

ISSUE DATE: \_\_\_\_\_

BOAT/HULL: \_\_\_\_\_

BOATALT/LAR NO.	BRIEF DESCRIPTION	COMPLETE (Yes/No)	REMARKS
-----------------	-------------------	----------------------	---------

---

---

---

---

---

---

## ATTACHMENT B

1. General inspection: Fasteners must bear markings identifying material to be compatible with the system. Black-oxide coated fasteners and fasteners without markings are not acceptable. Joints with mixed material fasteners are not acceptable.
2. Engaged Thread Area: Cracks are not acceptable.
  - 2.1 Broken, chipped, or missing threads or other indications of brittle material failure, are not acceptable.
  - 2.2 Galling, spalling, or pitting is not acceptable.
  - 2.3 Major defects are not acceptable. A major defect is a single defect (after removal of sharp edges and raised metal) that has a depth over one-half the thread depth.
  - 2.4 Isolated minor defects are acceptable. A minor defect is a single nick, gouge, or flattened thread (after removal of sharp edges and raised metal) that has a depth greater than 1/64-inch, but less than one-half the thread height (depth), and a width less than the thread spacing (pitch). Defects less than 1/64-inch deep may be ignored.
    - 2.4.1 An isolated minor defect that exceeds the width criterion for a minor defect is acceptable when the total length of the defect does not exceed 15 percent of one thread length in any one complete thread.
    - 2.4.2 Any combination of minor defects is acceptable when the total combined length of the defects does not exceed 15 percent of one thread length in any one complete thread.
  - 2.5 Repaired threads that engage with a non-self-locking Class 3-B fit nut, turned with fingers, are acceptable.
3. Non-Engaged Thread Area:
  - 3.1 Cracks are not acceptable.
  - 3.2 For externally threaded fasteners, no minimum thread form is required, except as needed to provide initial thread engagement and passing of the nut.
4. Self-locking nuts must have prevailing torque in accordance with 2.7. Cuts, tears, or looseness in self-locking elements or the adjacent metal is not acceptable.
  - 4.1 Determine adequate torque values in accordance with Table 075-5-1 of 2.7.
5. Deformed or damaged flats on fasteners are not acceptable.
6. Discard fasteners not meeting the acceptance requirements of this item.