

NAVSEA
STANDARD ITEM

FY-21

ITEM NO: 009-62
DATE: 01 OCT 2018
CATEGORY: II

1. SCOPE:

1.1 Title: Boiler Handhole, Manhole Seat and Plate; inspect

2. REFERENCES:

2.1 S9221-C1-GTP-010, Main Propulsion Boilers; Repair and Overhaul

2.2 803-841216, Handhole Plates and Arch Bars for Boilers

3. REQUIREMENTS:

3.1 Remove each handhole and manhole plate from each header and drum of boiler. Each plate must be identified and tagged as to respective boiler.

3.2 Wire brush clean to bare metal each handhole, manhole plate, stud, strongback, and fastener. Wire brush clean to bare metal each handhole and manhole gasket seating surface using a power driven wire cup brush. Ensure complete removal of rust and gasket material.

3.2.1 Wire brush clean to bare metal external surfaces in way of "B" and "C" measurement contact areas using a power-driven wire wheel or needle gun.

3.3 Visually inspect each gasket seating surface of handhole and manhole plates and the drum and header for erosion, corrosion, gouges, steam cuts, crack indications, excessive pitting, grooves, and any irregularities that may cause poor or leaky joints. Inspect external surfaces of headers in way of "B" and "C" measurement areas for erosion and corrosion. Inspect studs and nuts for deterioration and damaged and stripped threads.

3.3.1 Visually inspect, measure, and record the following handhole and manhole gasket seating surface criteria in accordance with Paragraph 5-8.2 of 2.1 and Attachment A.

3.3.1.1 Seat taper: Use template of flat stock and feeler gage to measure maximum taper around periphery of handhole and manhole seats.

3.3.1.2 Minimum wall thickness: Measure header wall thickness using a point micrometer at each side of the header cross sectional minor axis.

3.3.1.3 Minimum seat thickness: Measure header seat thickness with a flat-faced micrometer at the 4 points of the header cross sectional major and minor axis.

3.3.1.4 Handhole Plate Overlap: Measure maximum gap clearance between shoulder of the handhole plate and handhole with handhole plate located in the most extreme misaligned position. Subtract the measurement from the plate seat width to establish the amount of plate overlap. Handhole plates used for measurements must conform to 2.2.

3.3.1.5 Manhole Plate Clearance: Measure clearance between shoulder of manhole plate and manhole at 8, 45-degree increments, with the manhole plate accurately centered.

3.4 Submit one legible copy, in approved transferrable media, of a report listing results of the requirements of 3.3 to the SUPERVISOR. Report must list each handhole and manhole seat which failed to meet the minimum allowable values listed in Appendices 5D, 5E, and 6C of 2.1.

3.5 Install each handhole and manhole plate, using new gaskets conforming to MIL-G-15342 and applicable boiler technical manual.

4. NOTES:

4.1 Equipment technical manual will be listed in the invoking Work Item.

ATTACHMENT A

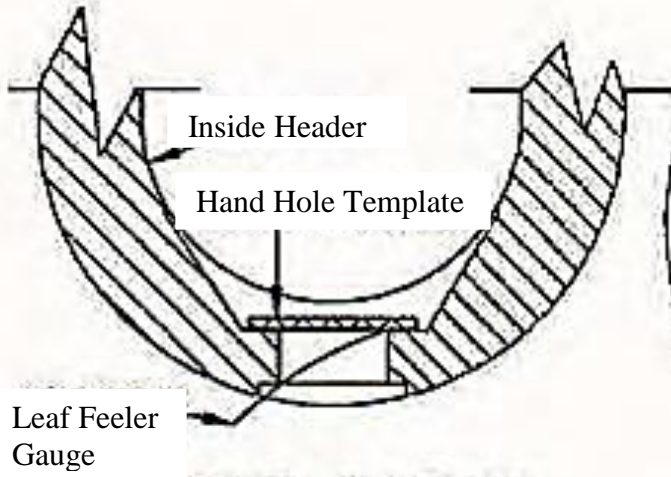

SEAT TAPER

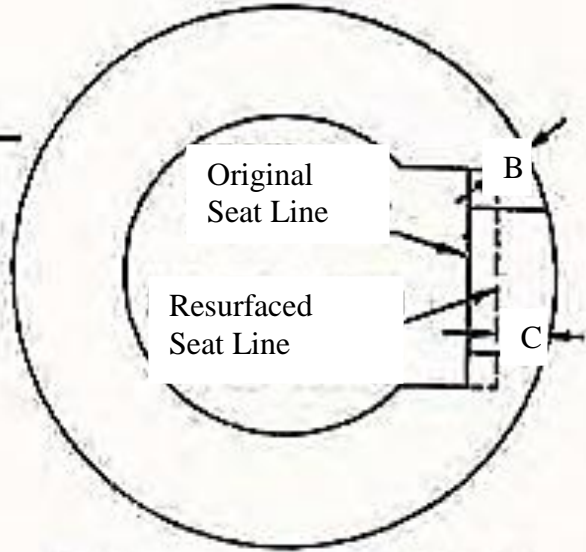

MIN. WALL THICKNESS-DIM. B
MIN. SEAT THICKNESS_DIM. C

MIN. WALL and SEAT

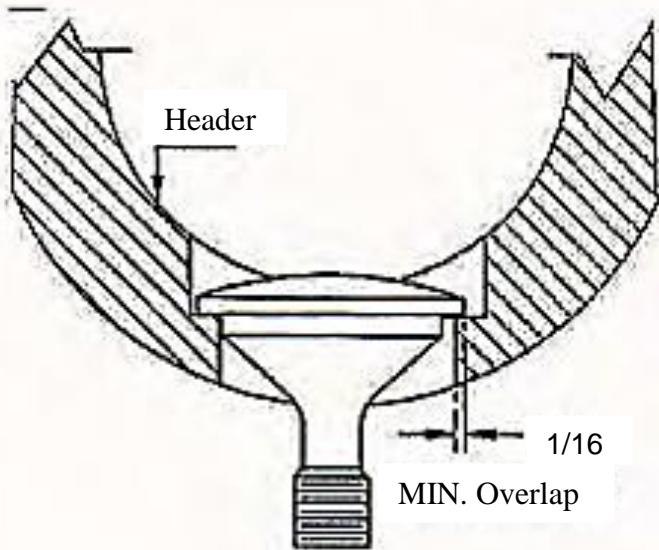

OVERLAP

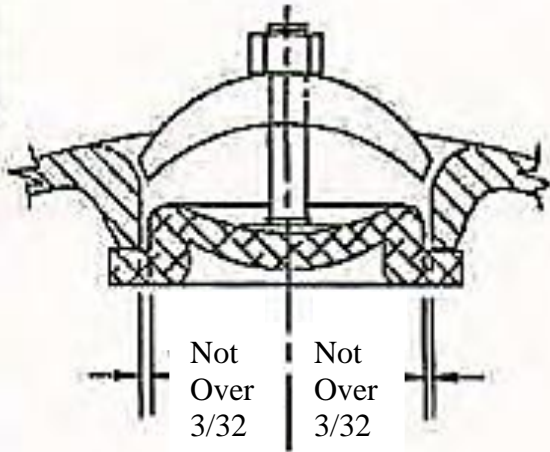

MANHOLE
CLEARANCE