

* Dual reporting (*) to CO/TD and Technical Department

* Dual reporting (*) to CO/TD and Corporate Operations

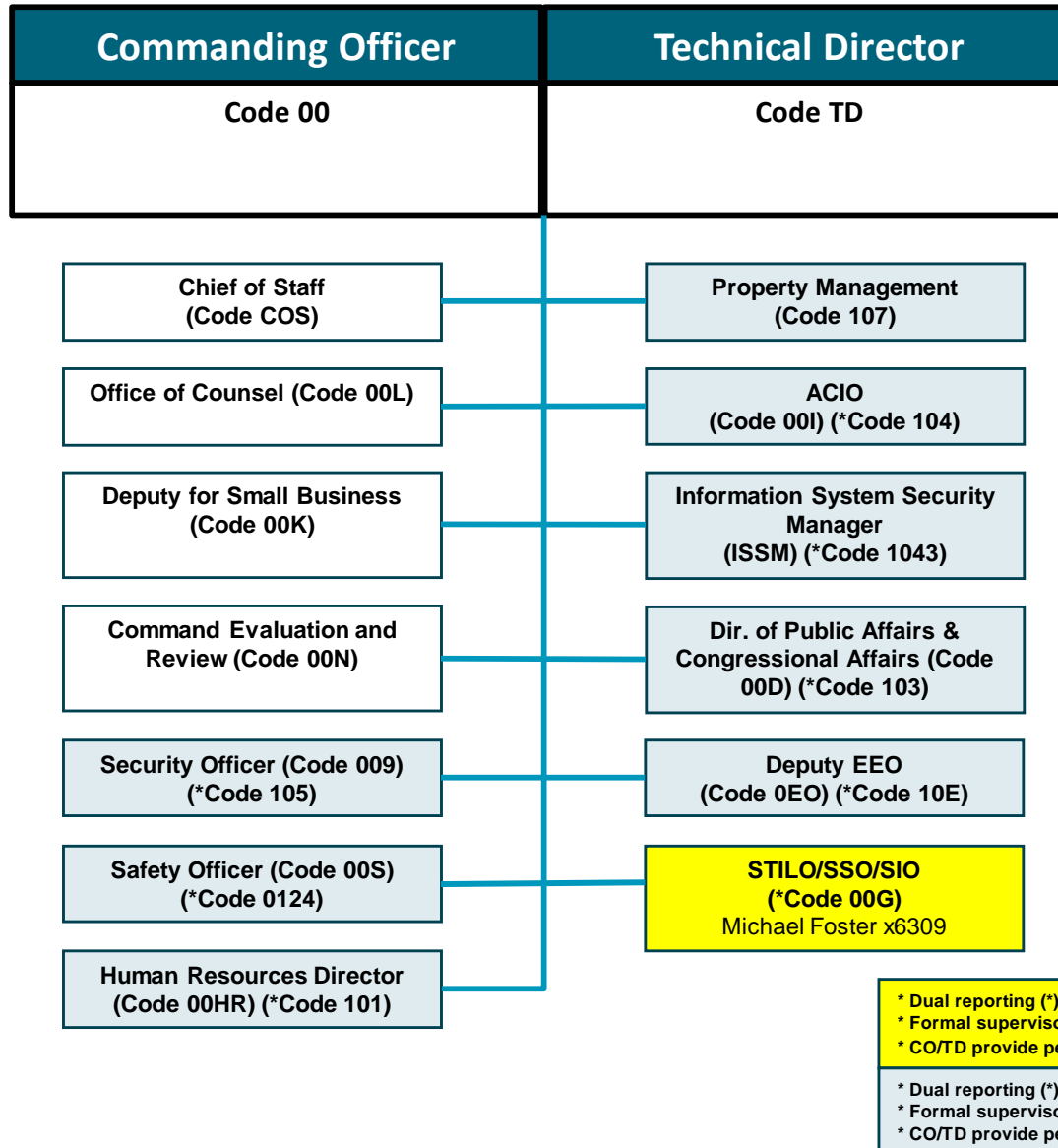

Statement A: Approved for Public Release.

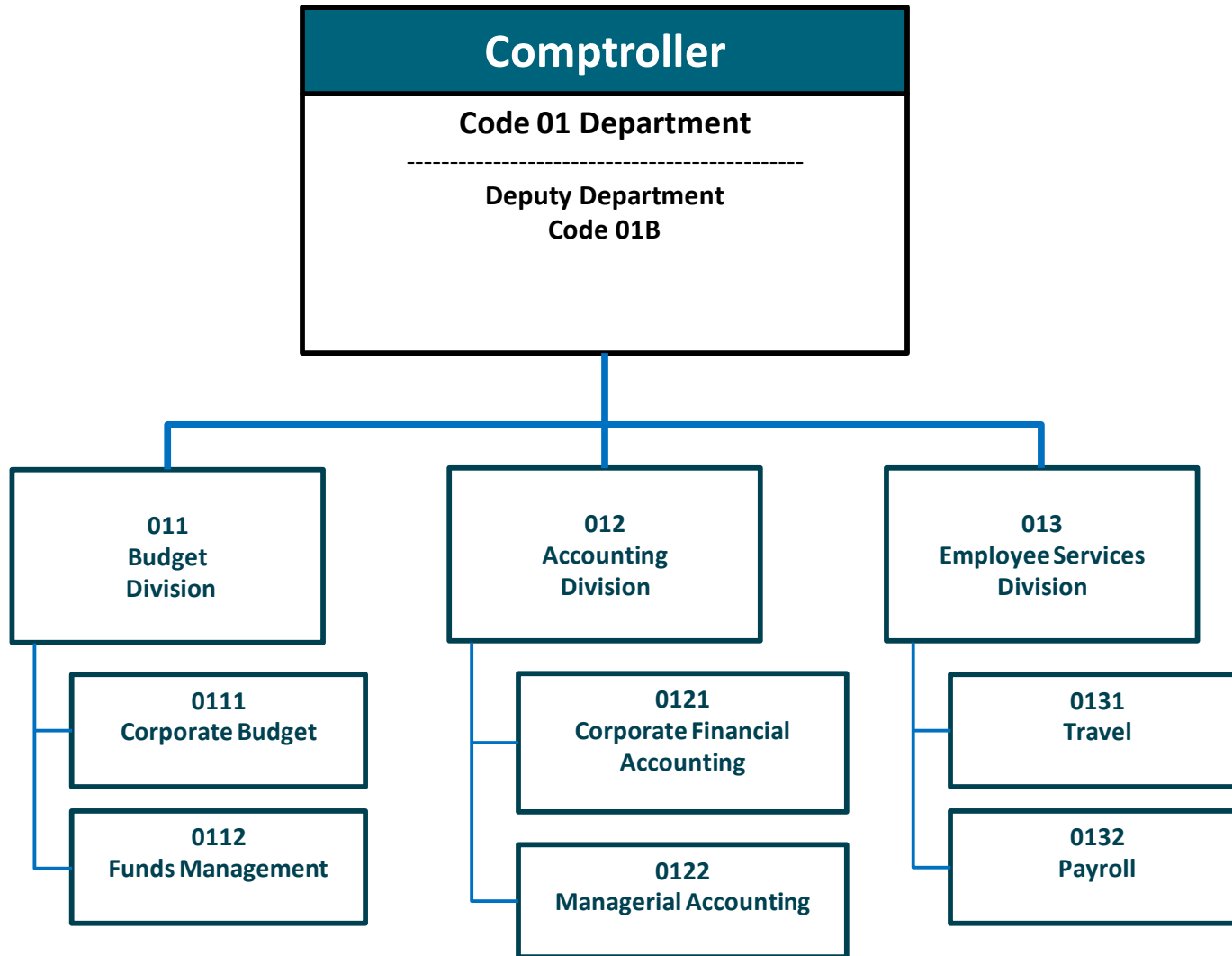

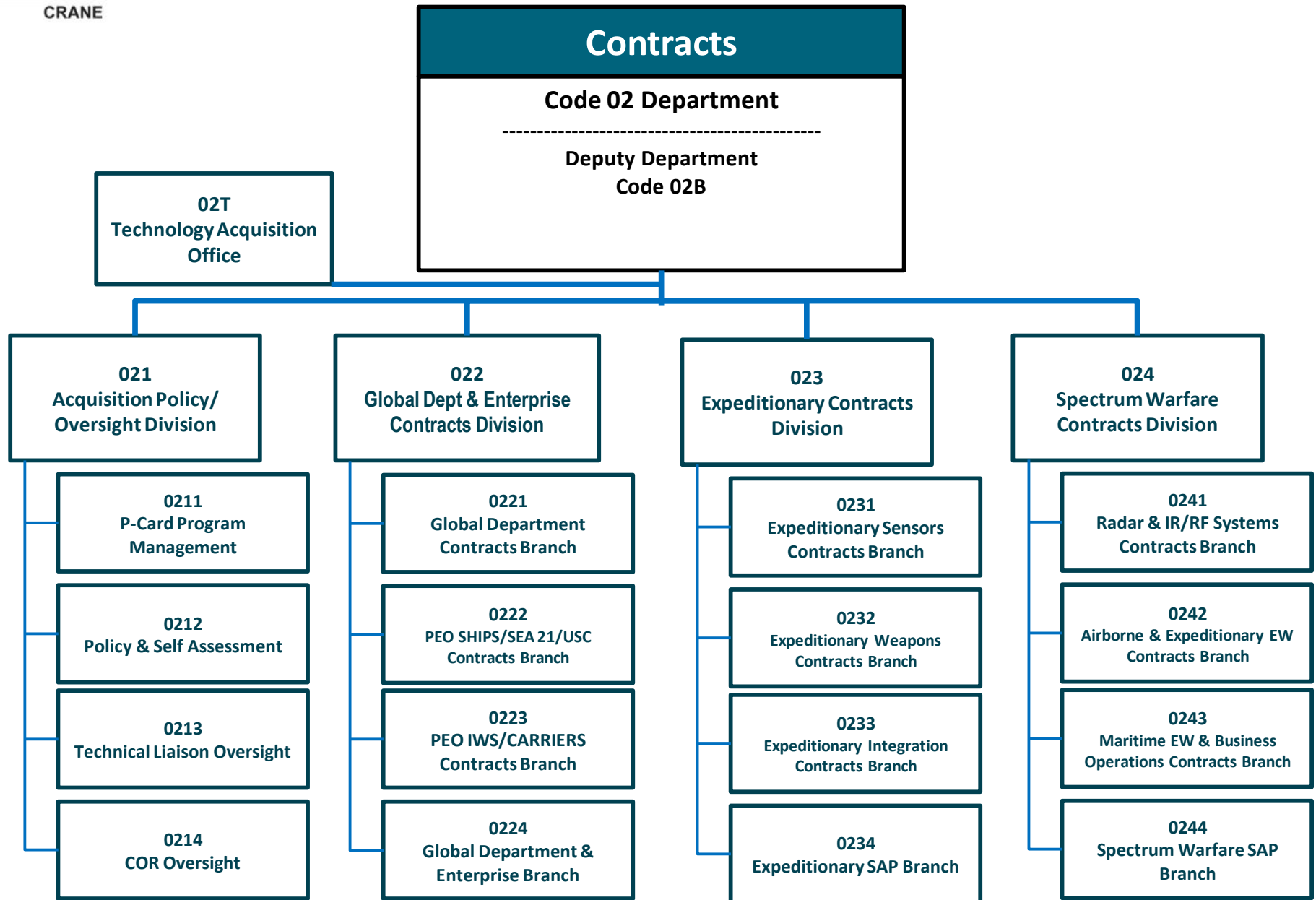

Statement A: Approved for Public Release.

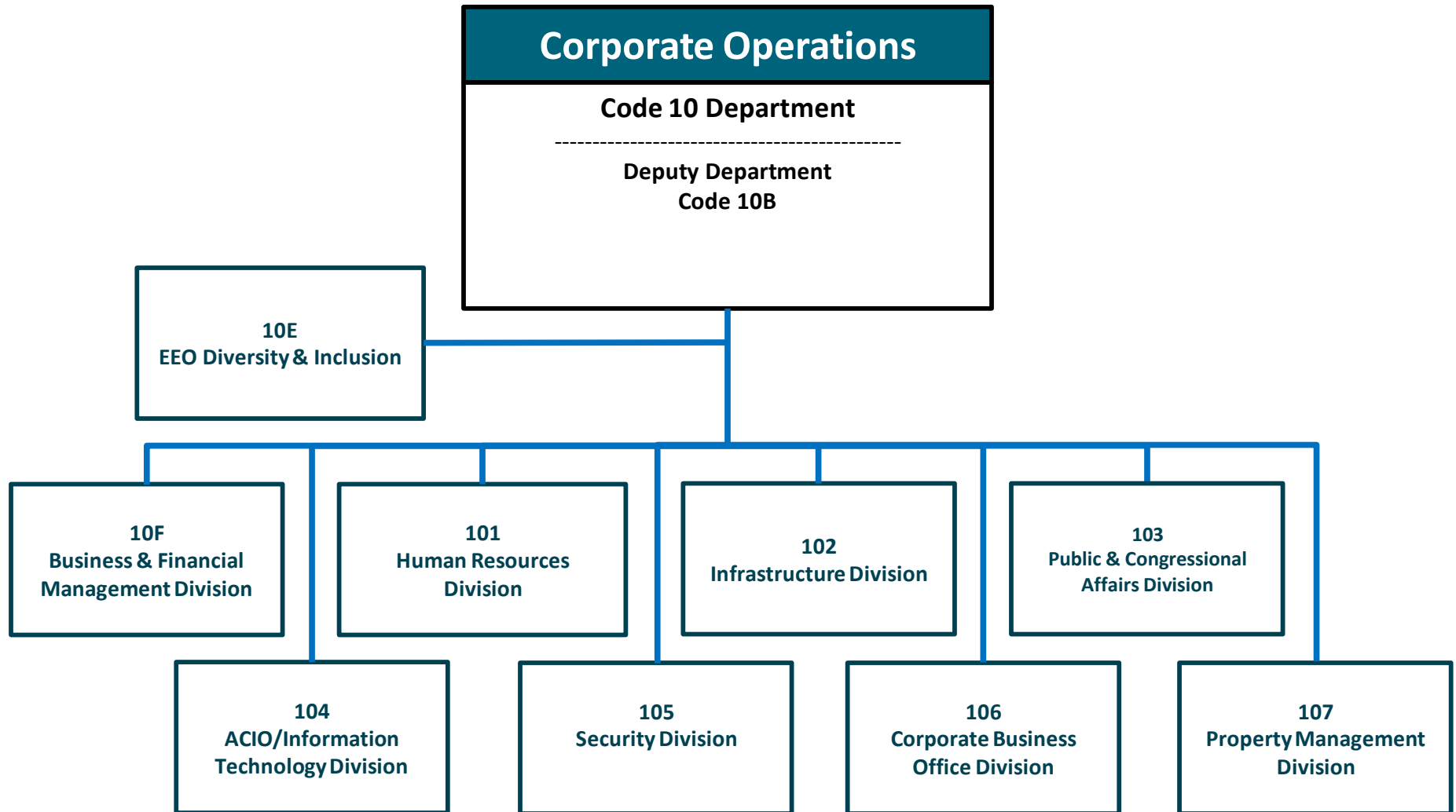

Statement A: Approved for Public Release.

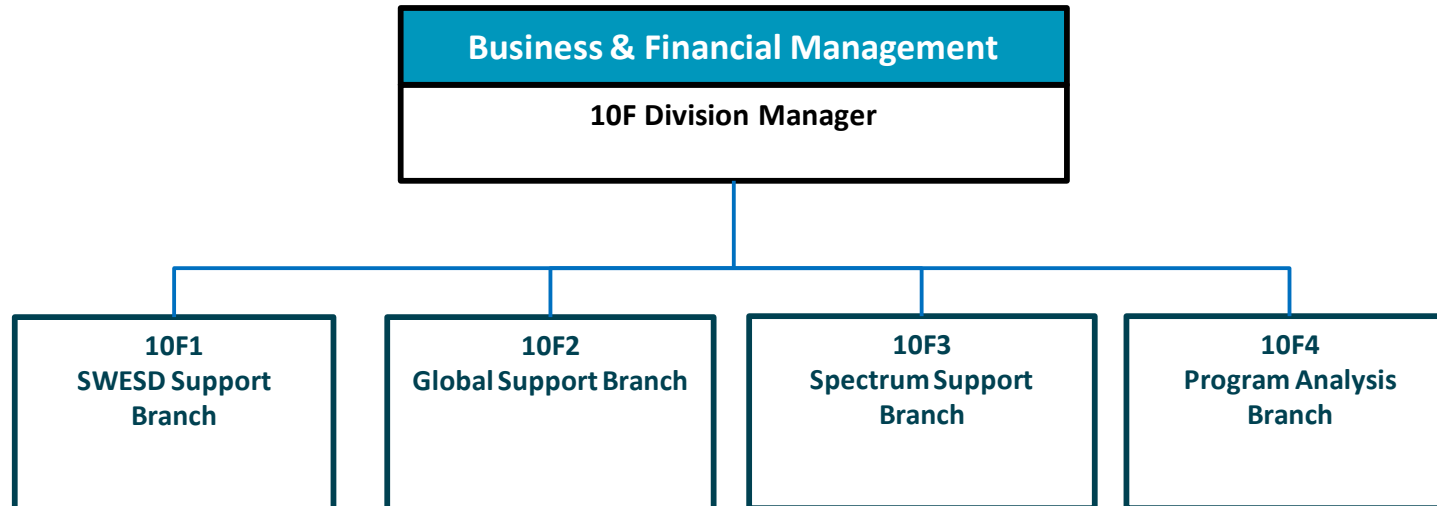

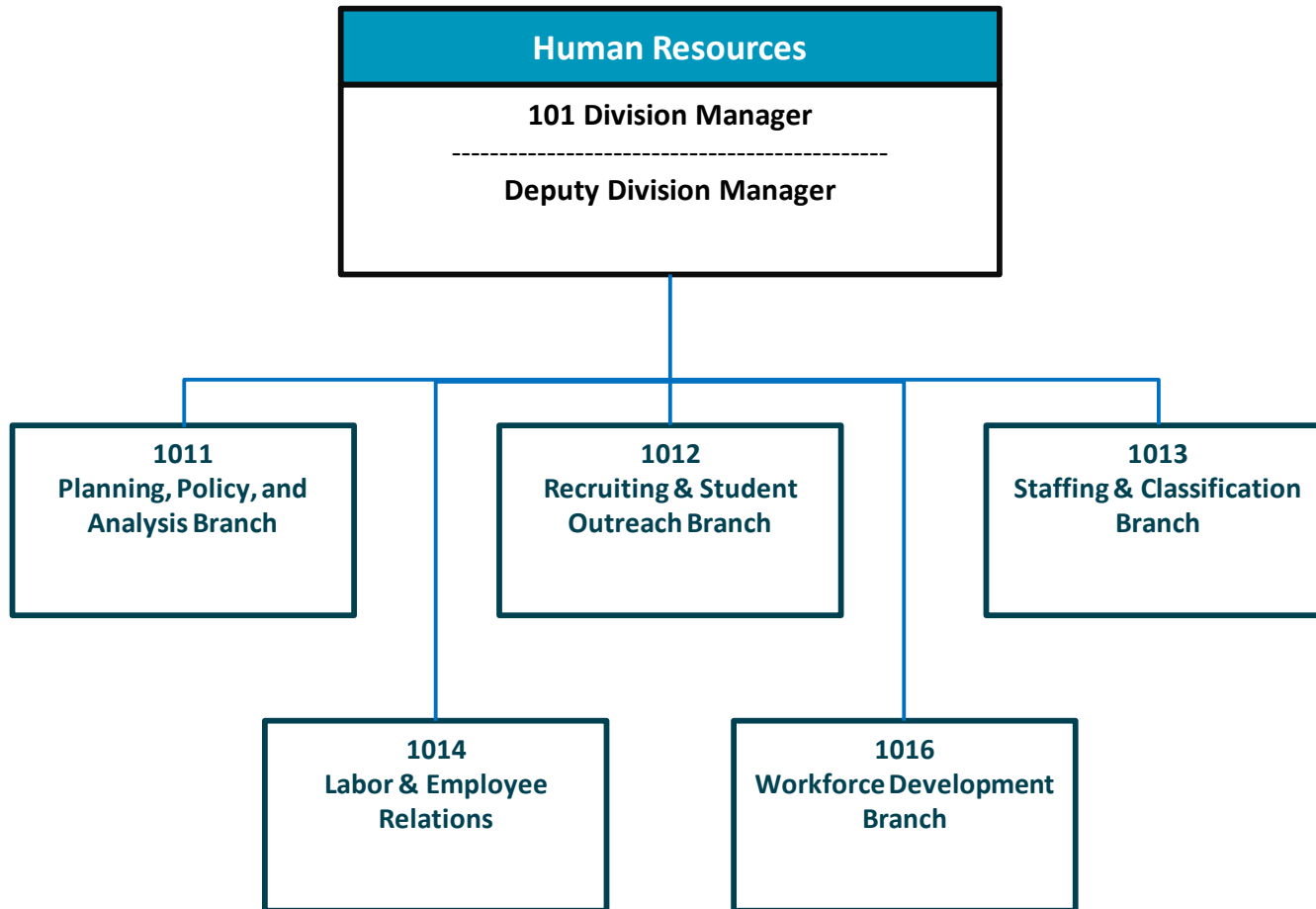

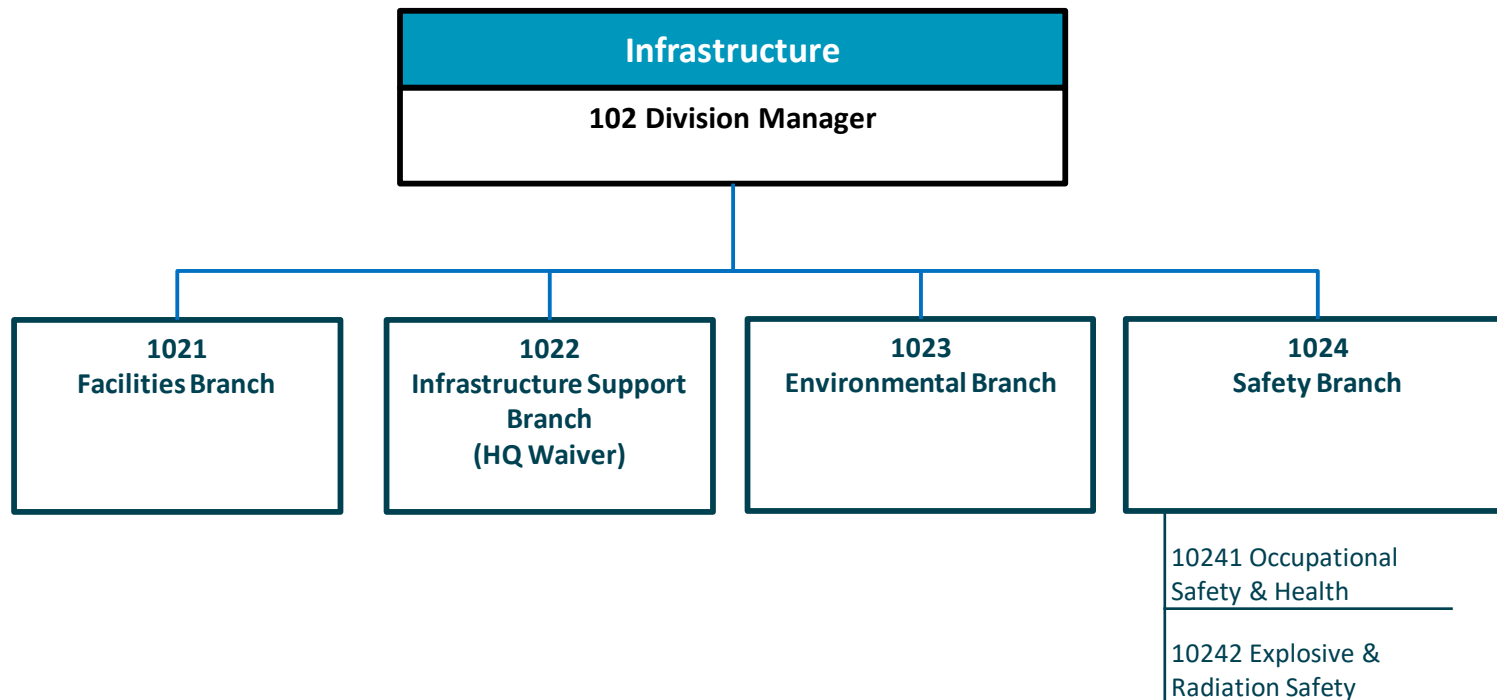

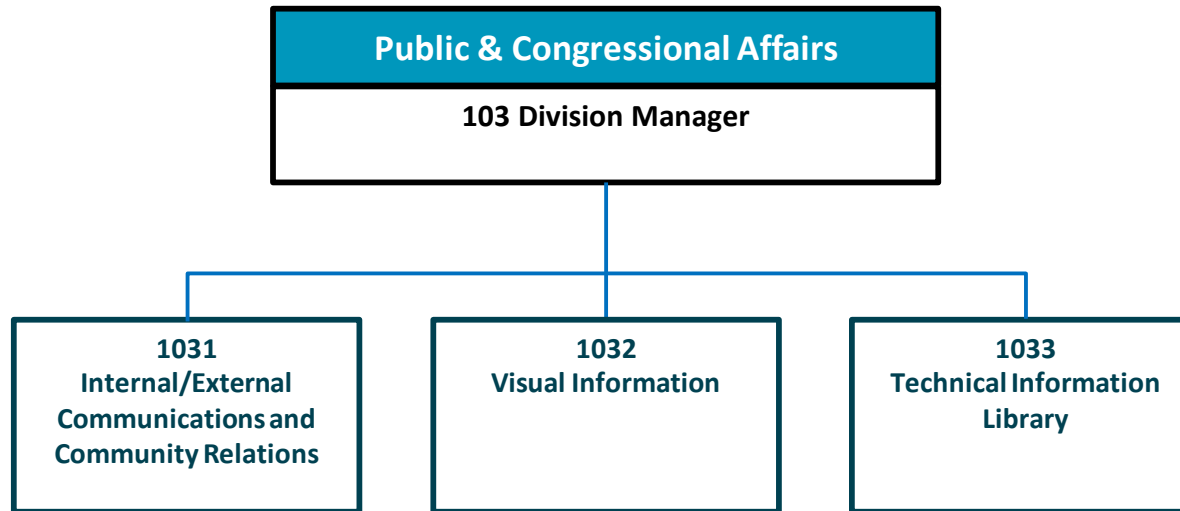

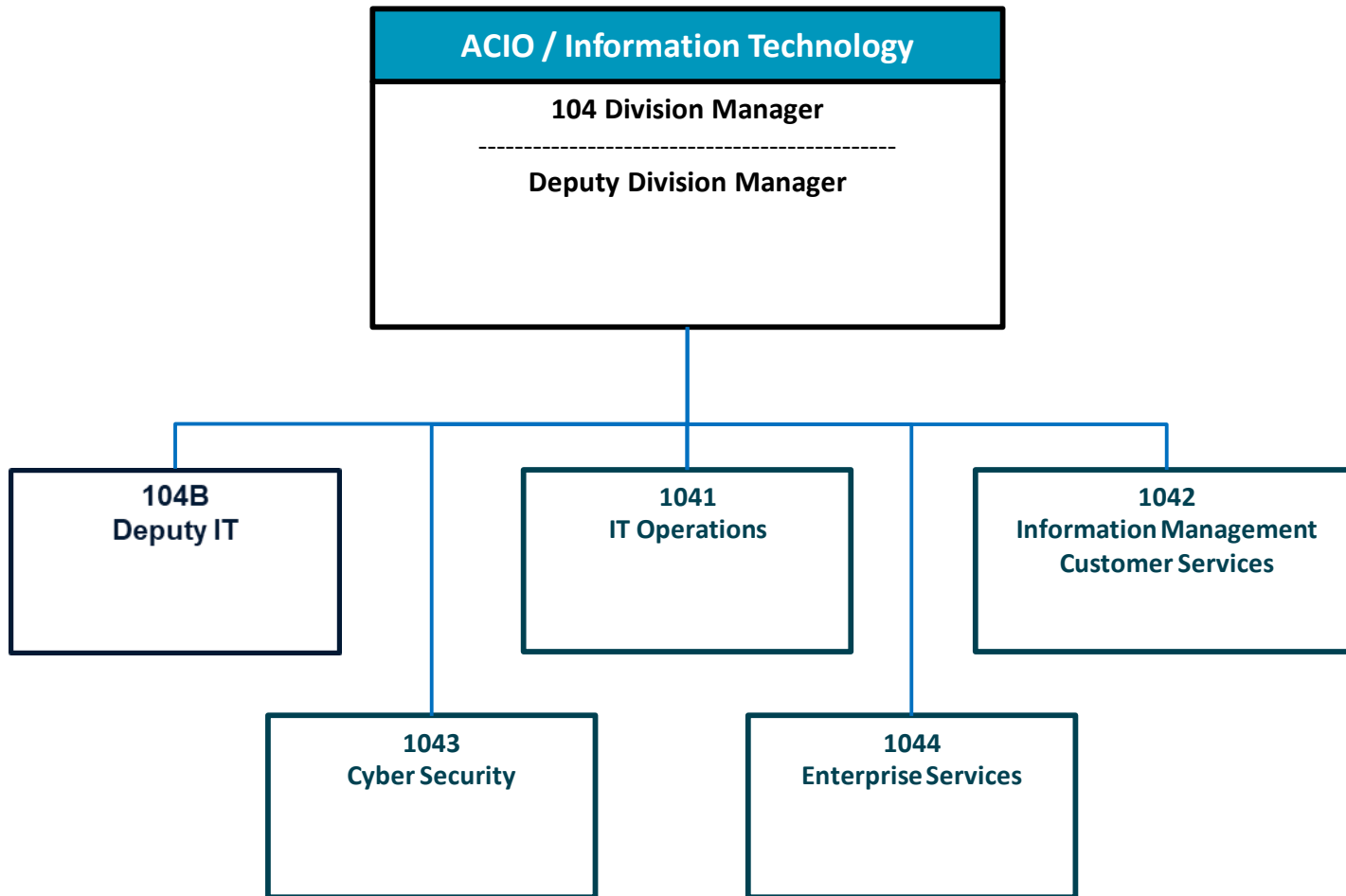

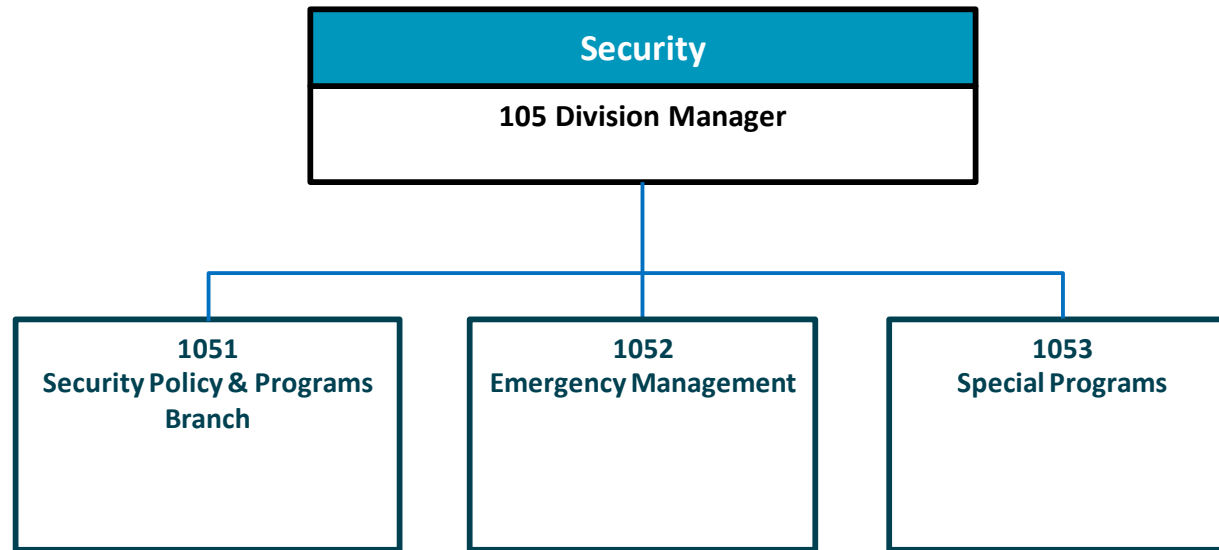

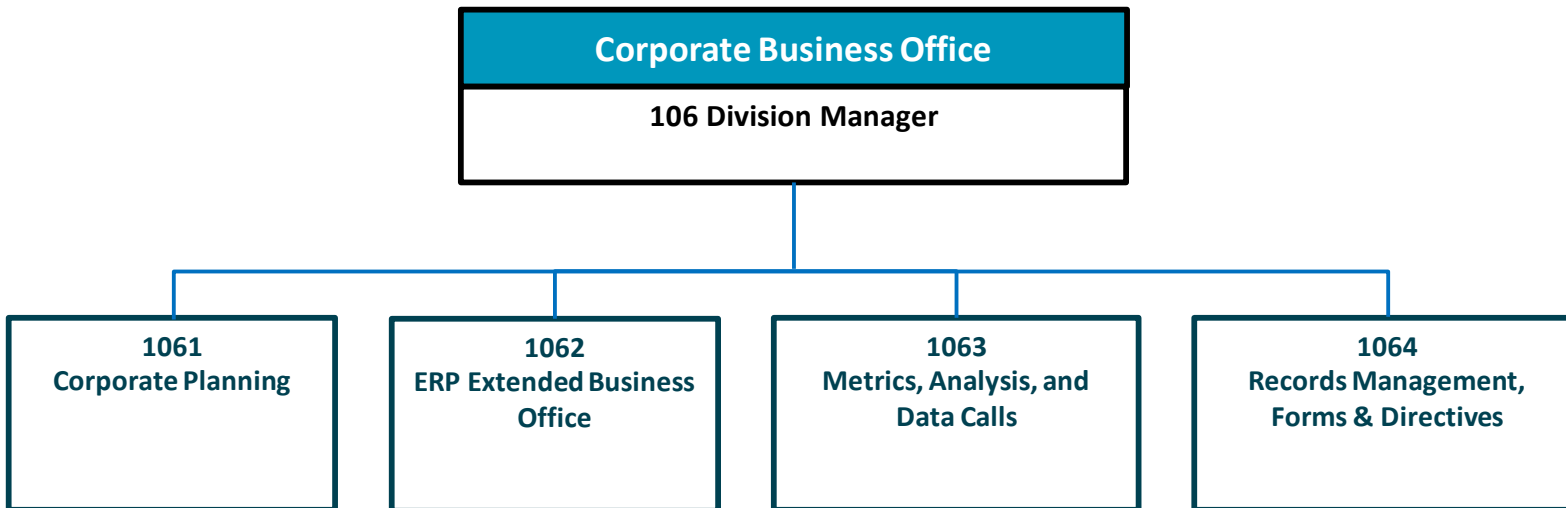

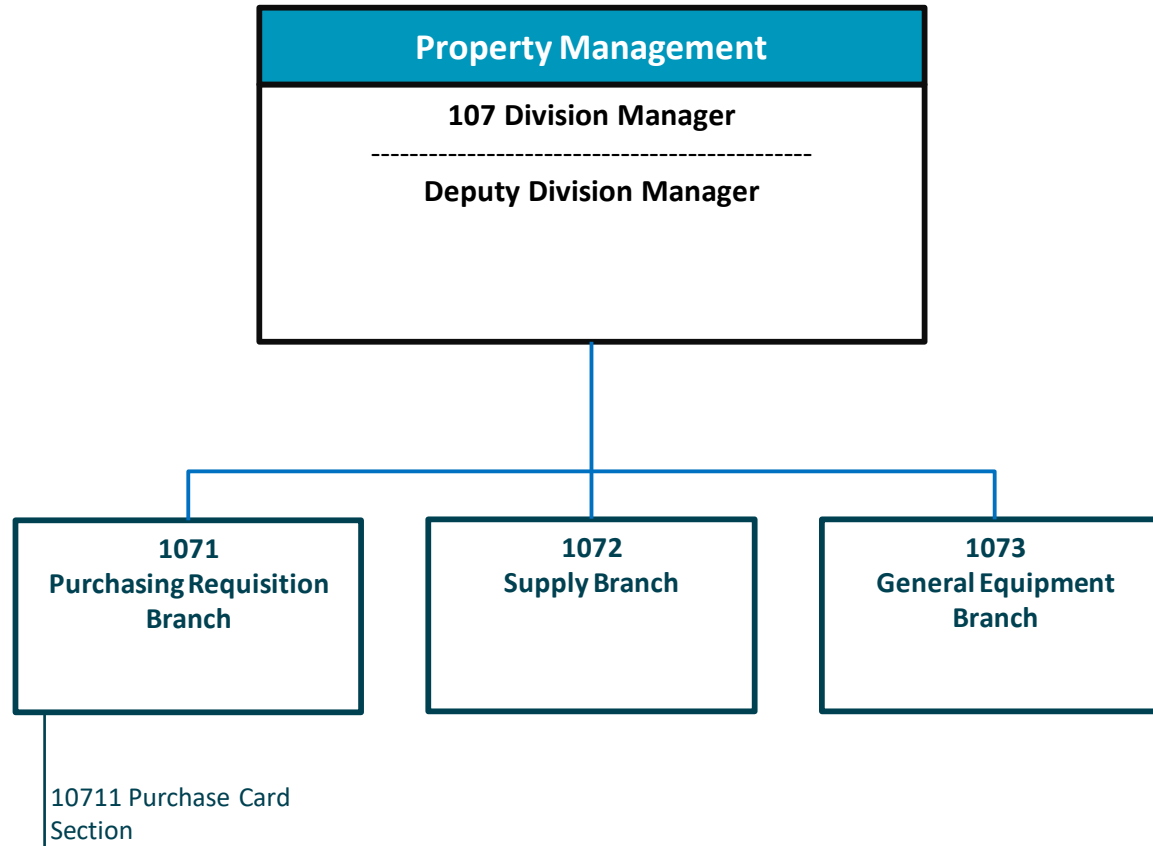

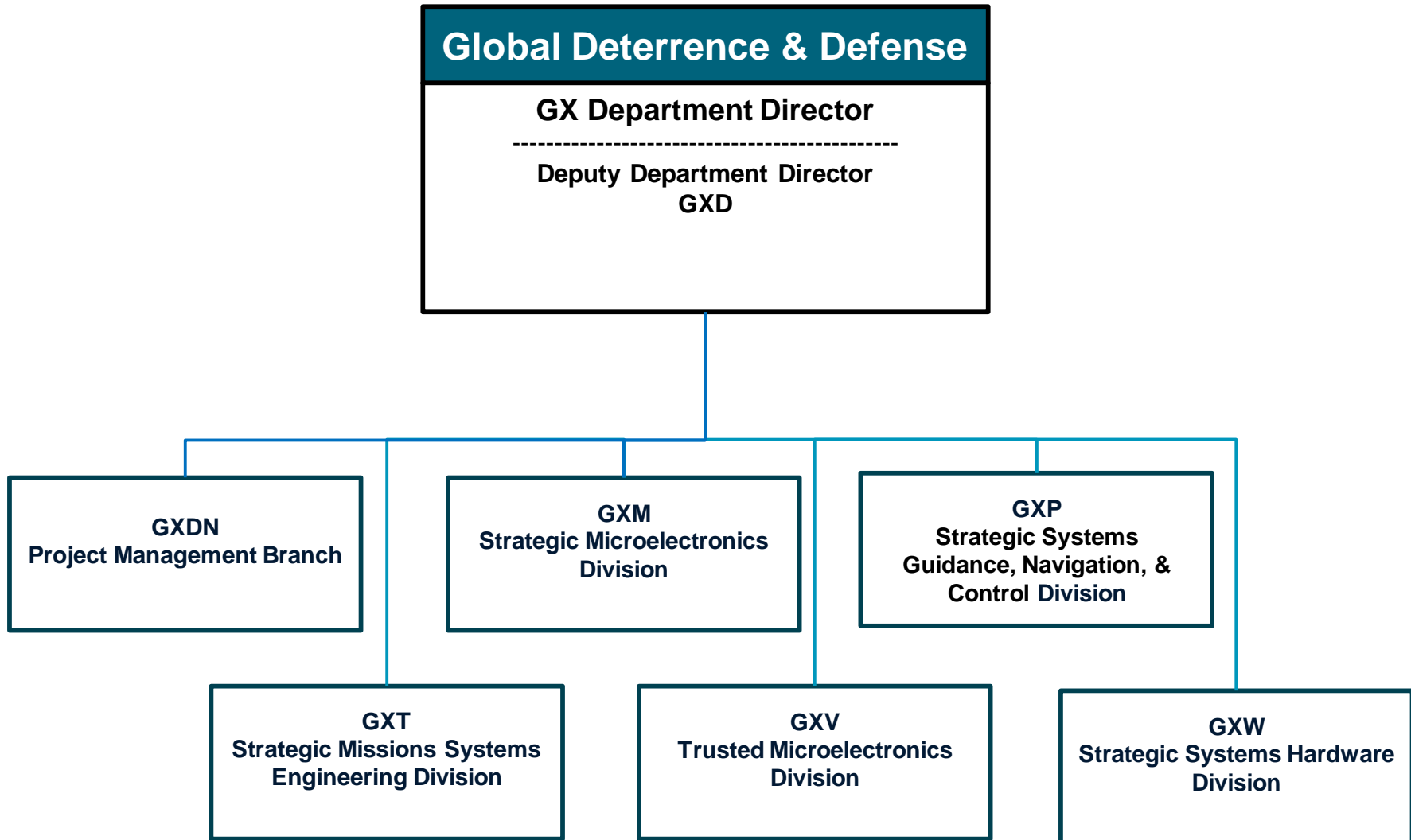

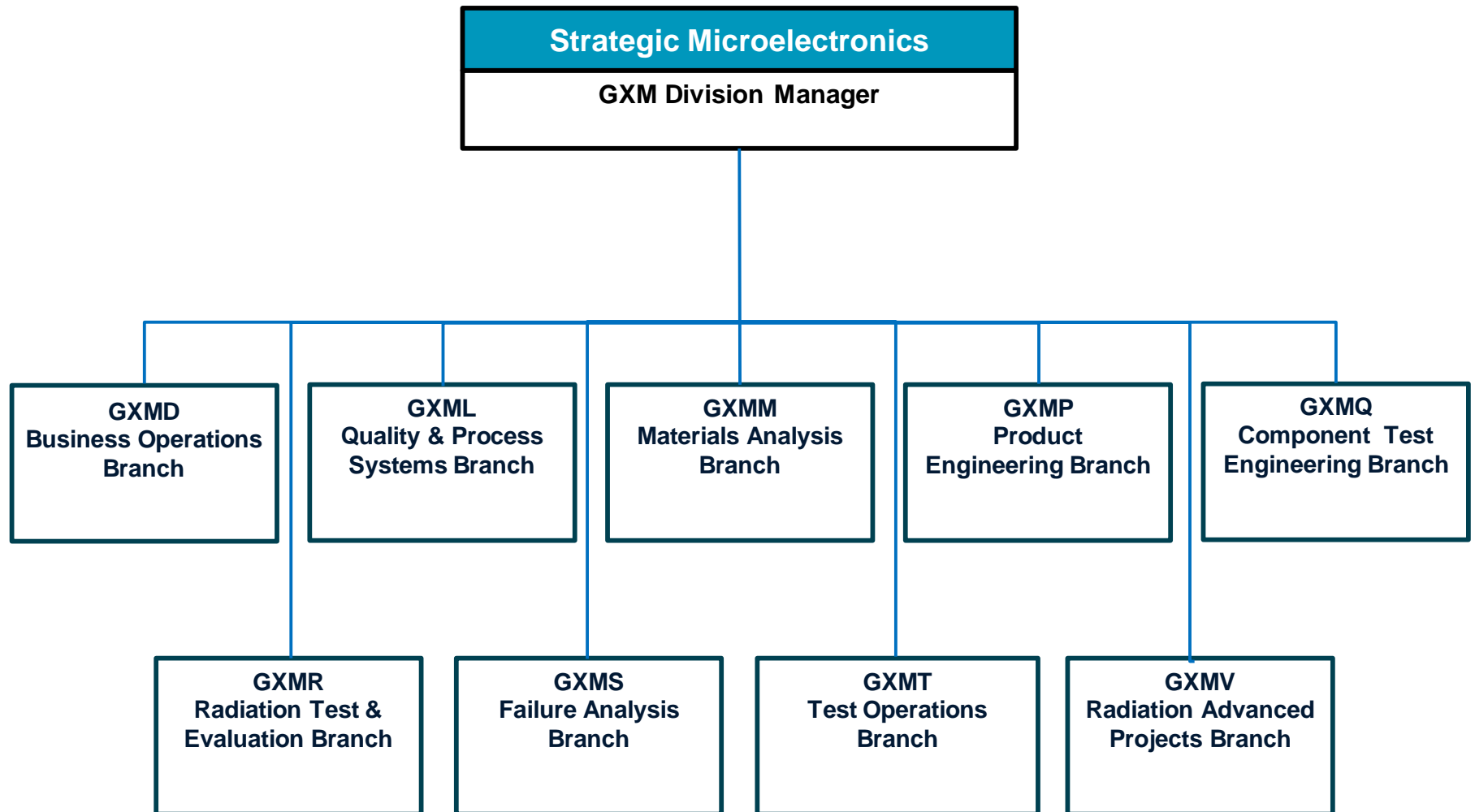

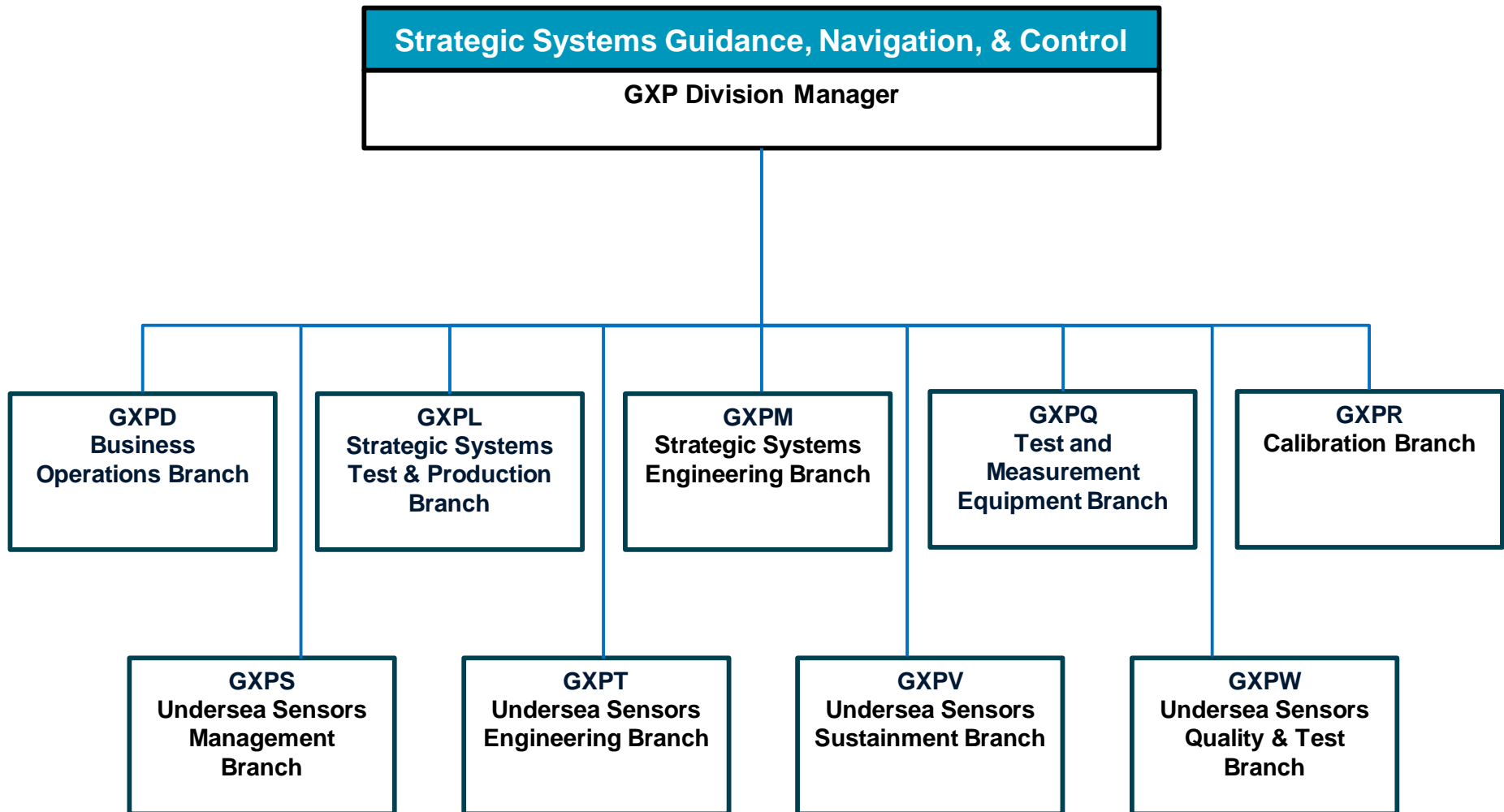

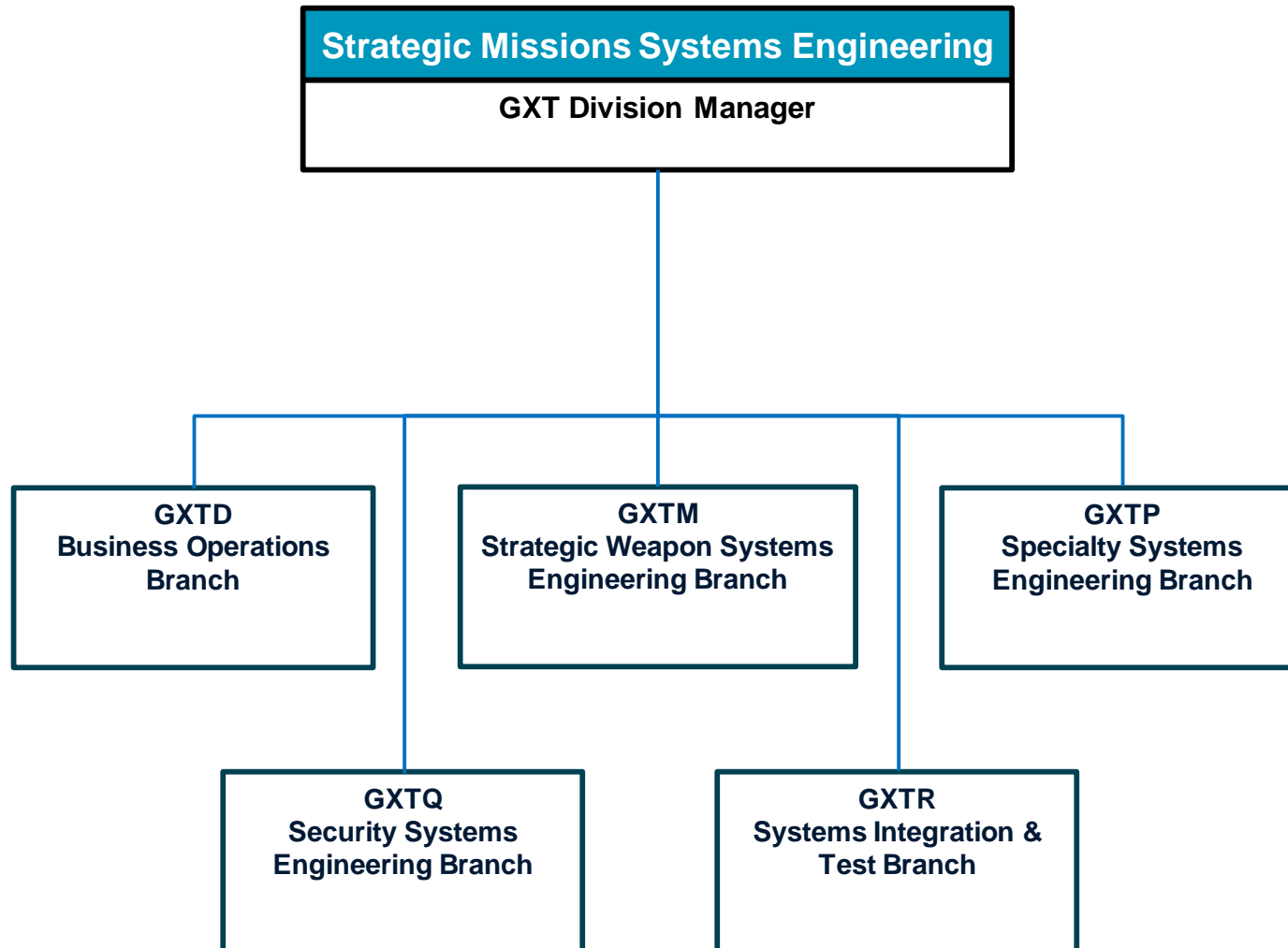

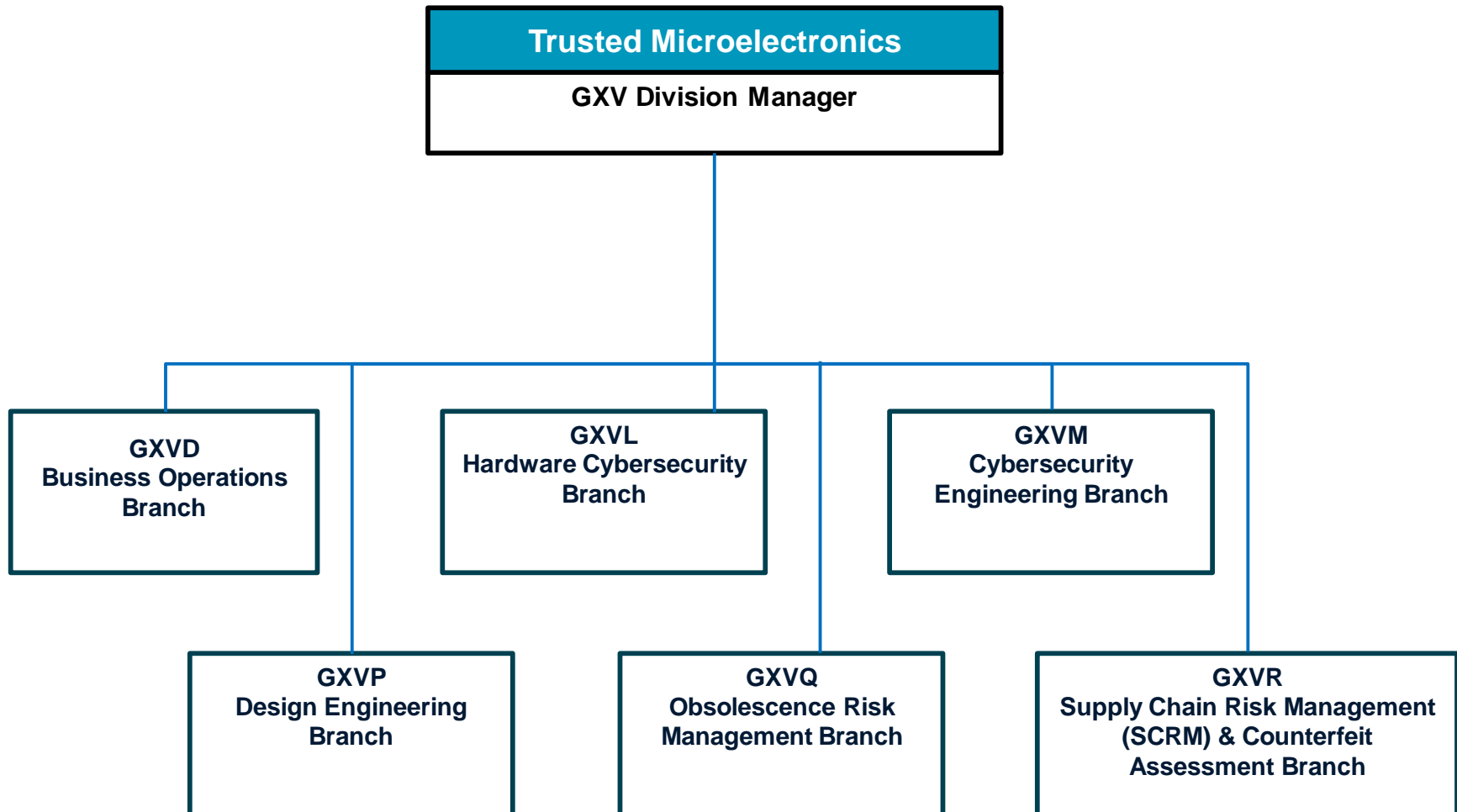

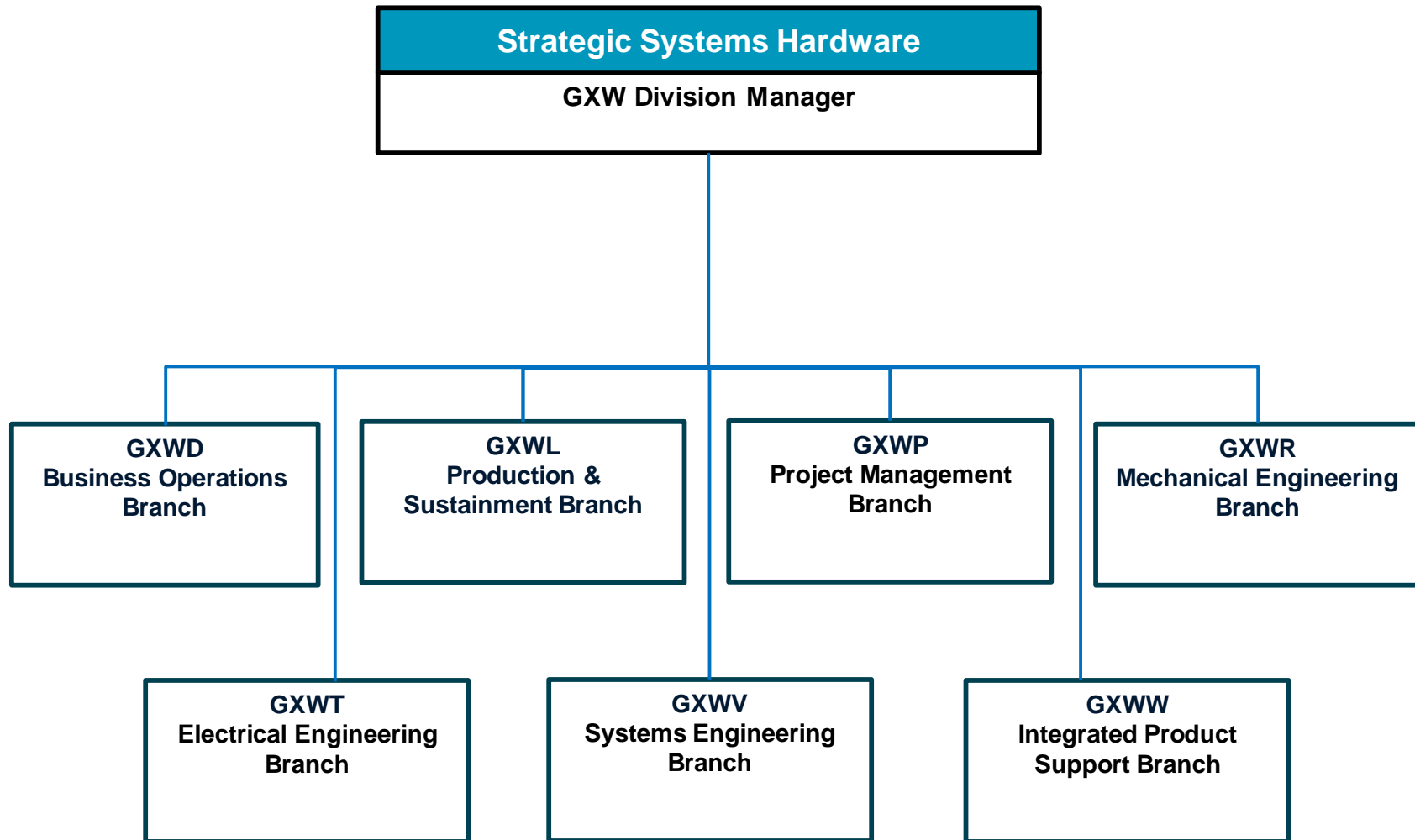

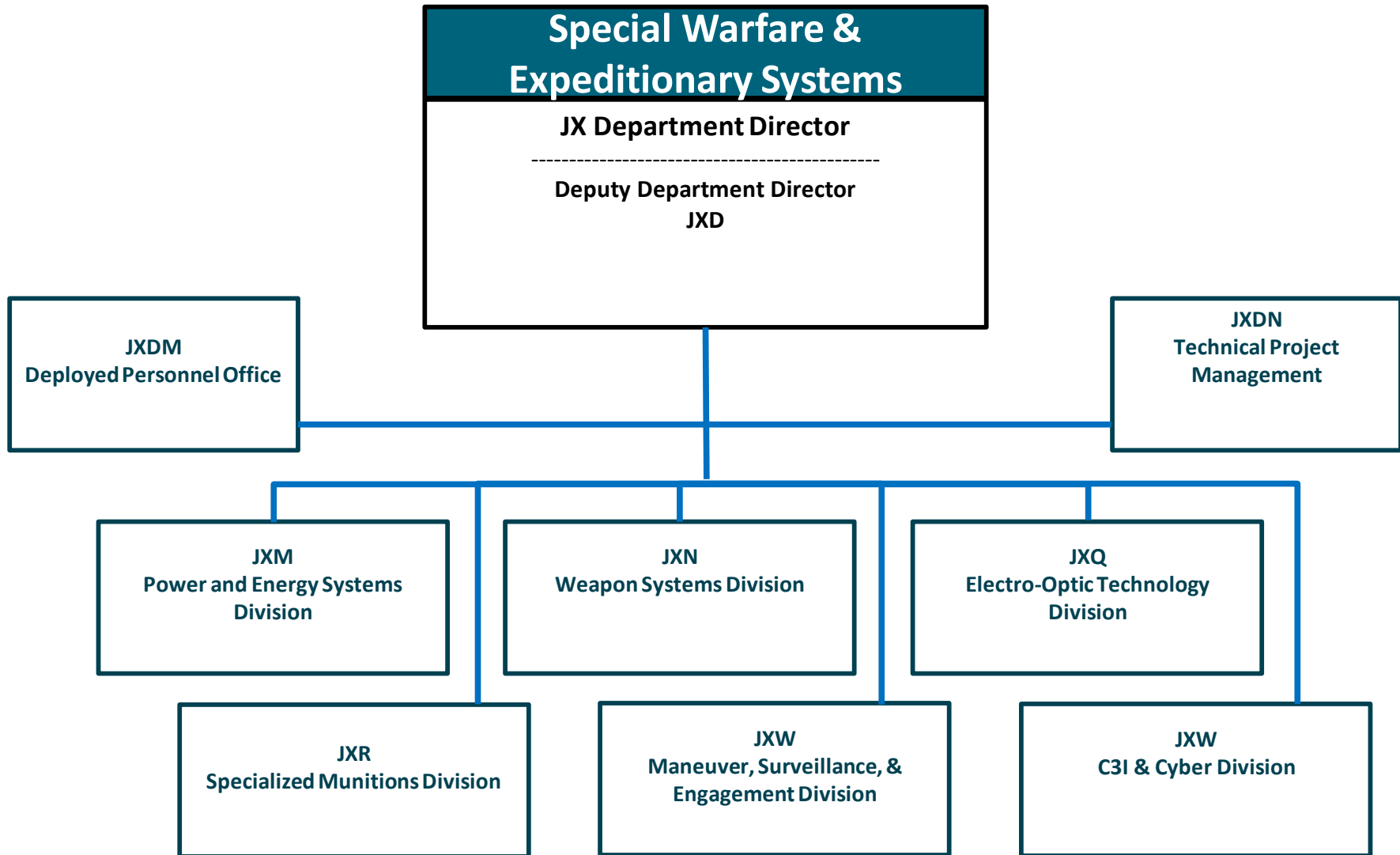

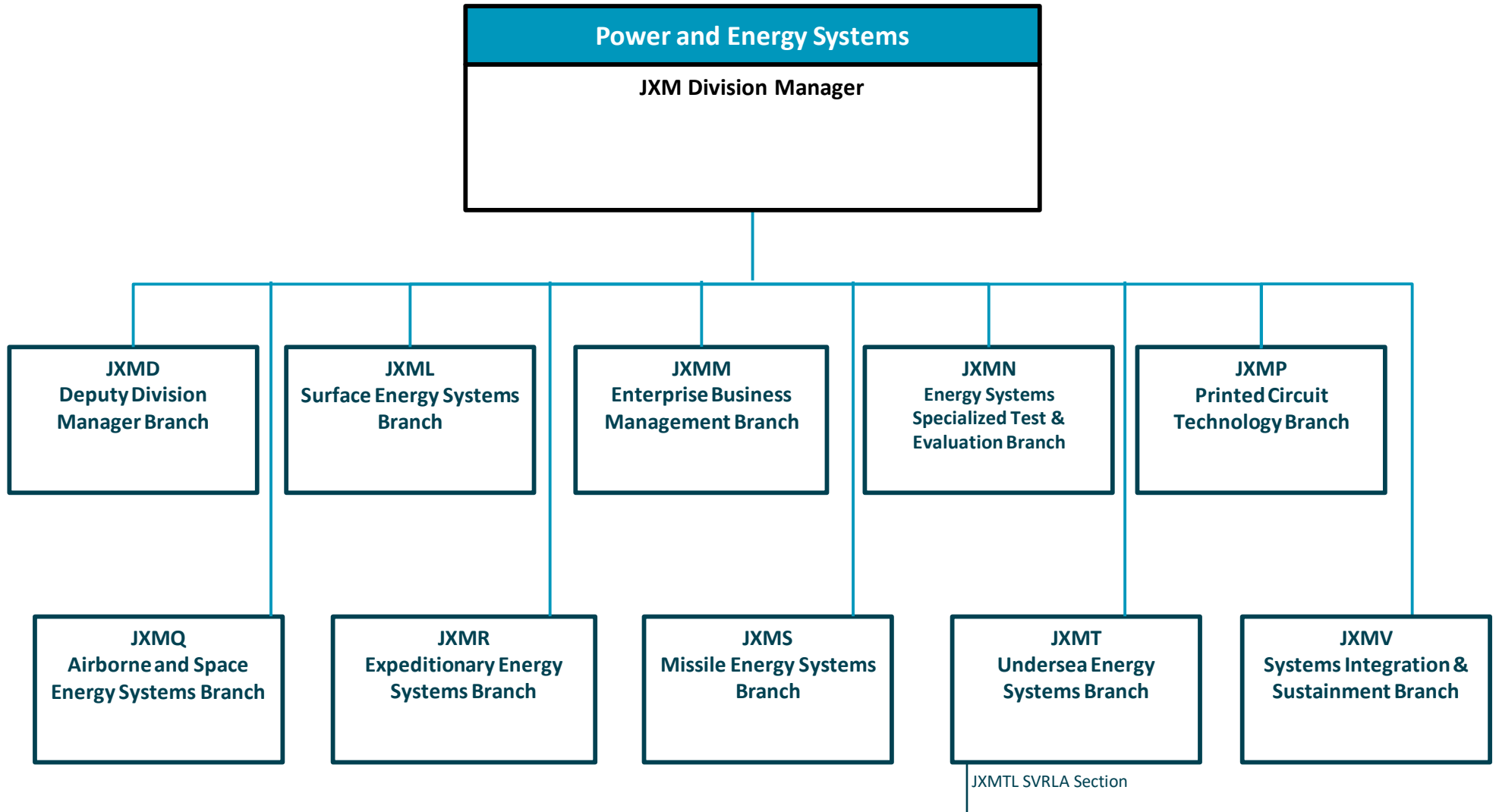

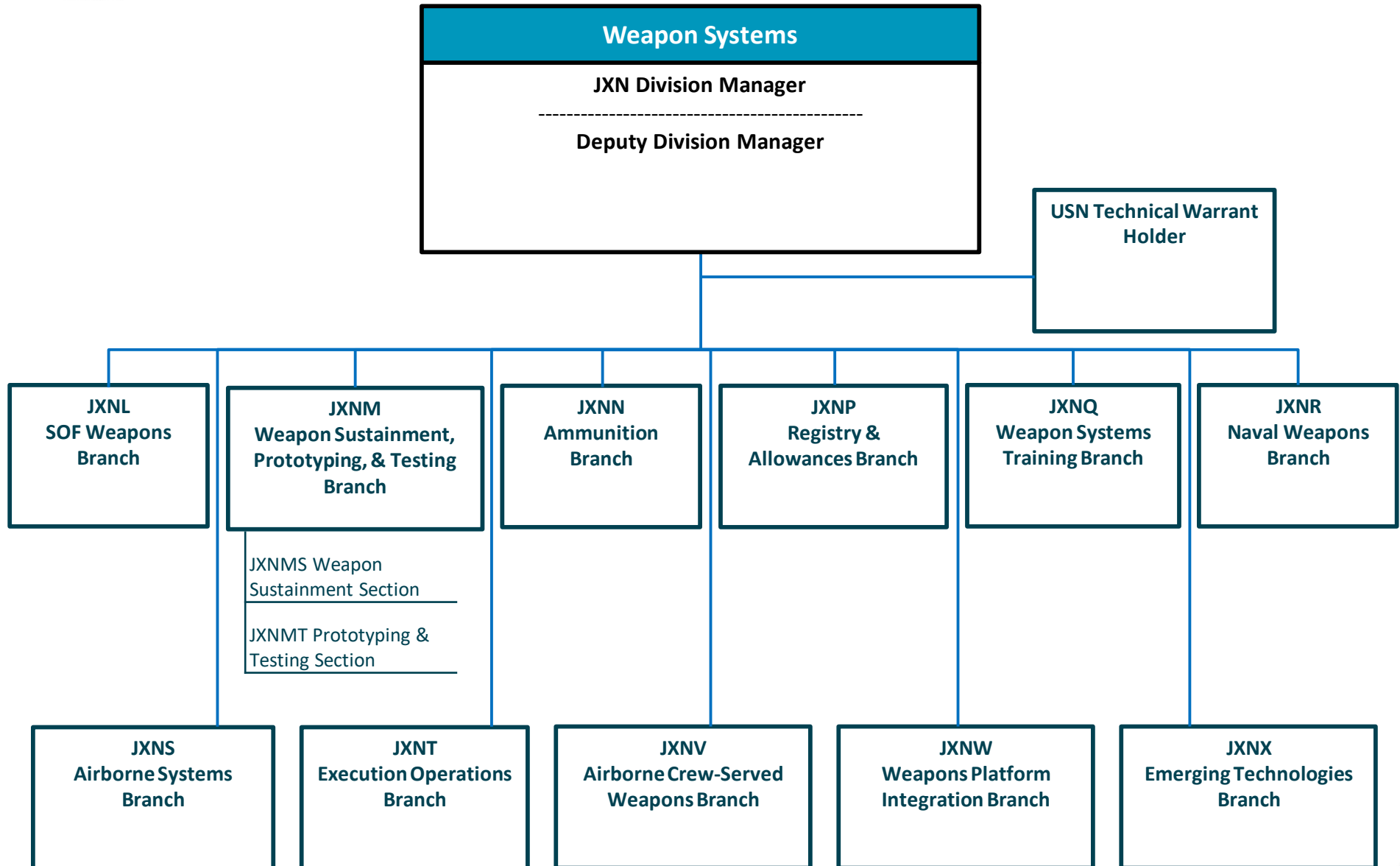

Statement A: Approved for Public Release.

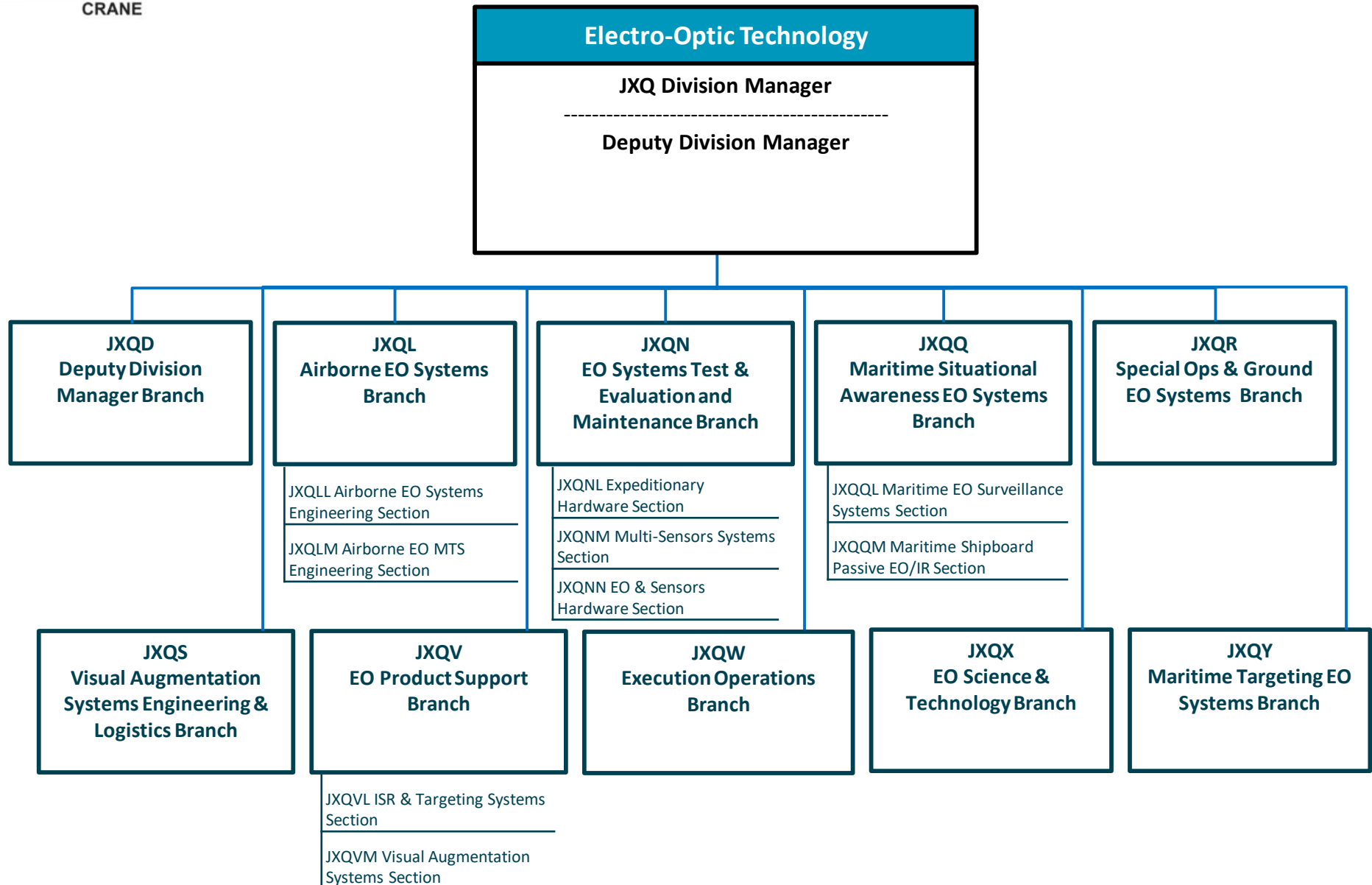

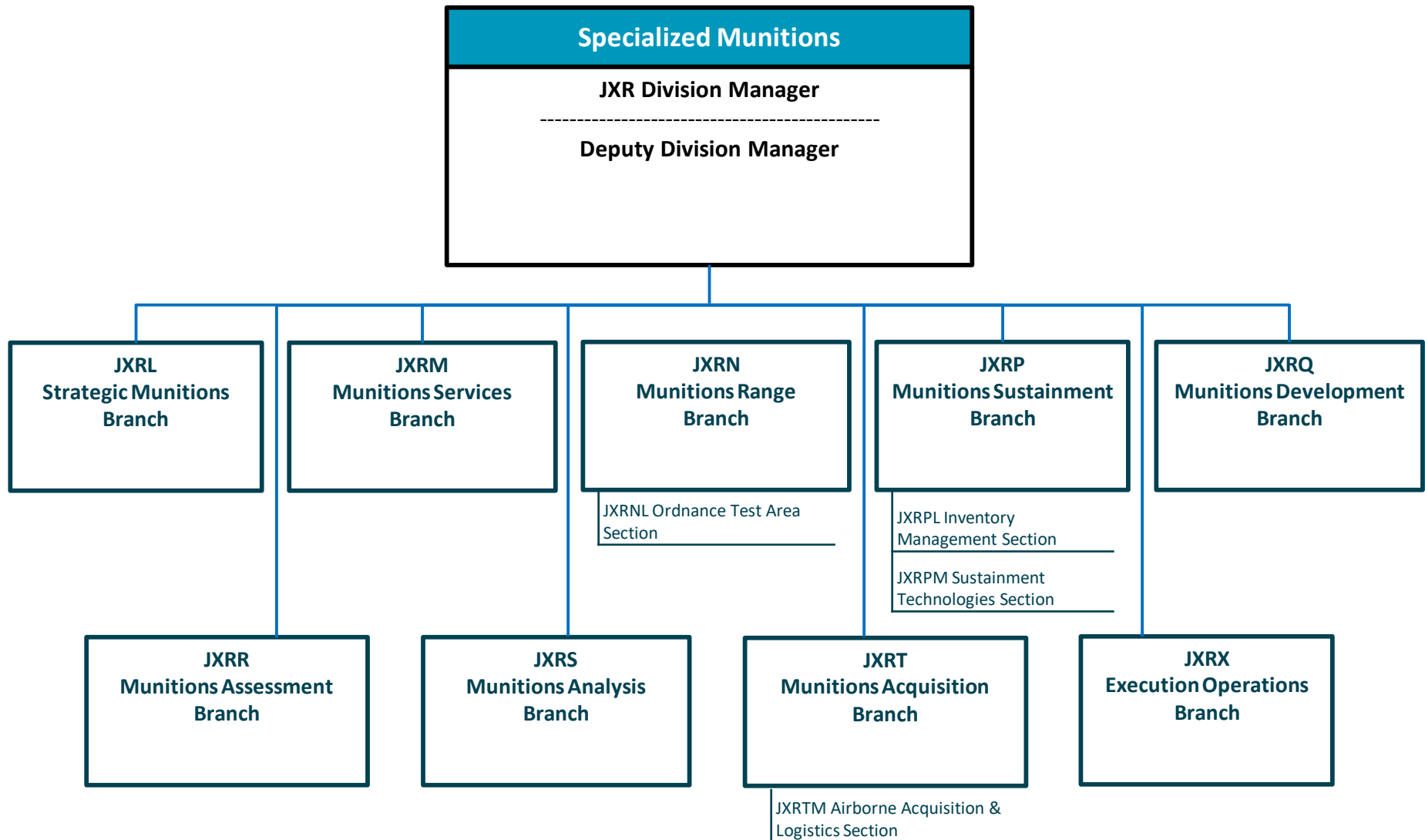

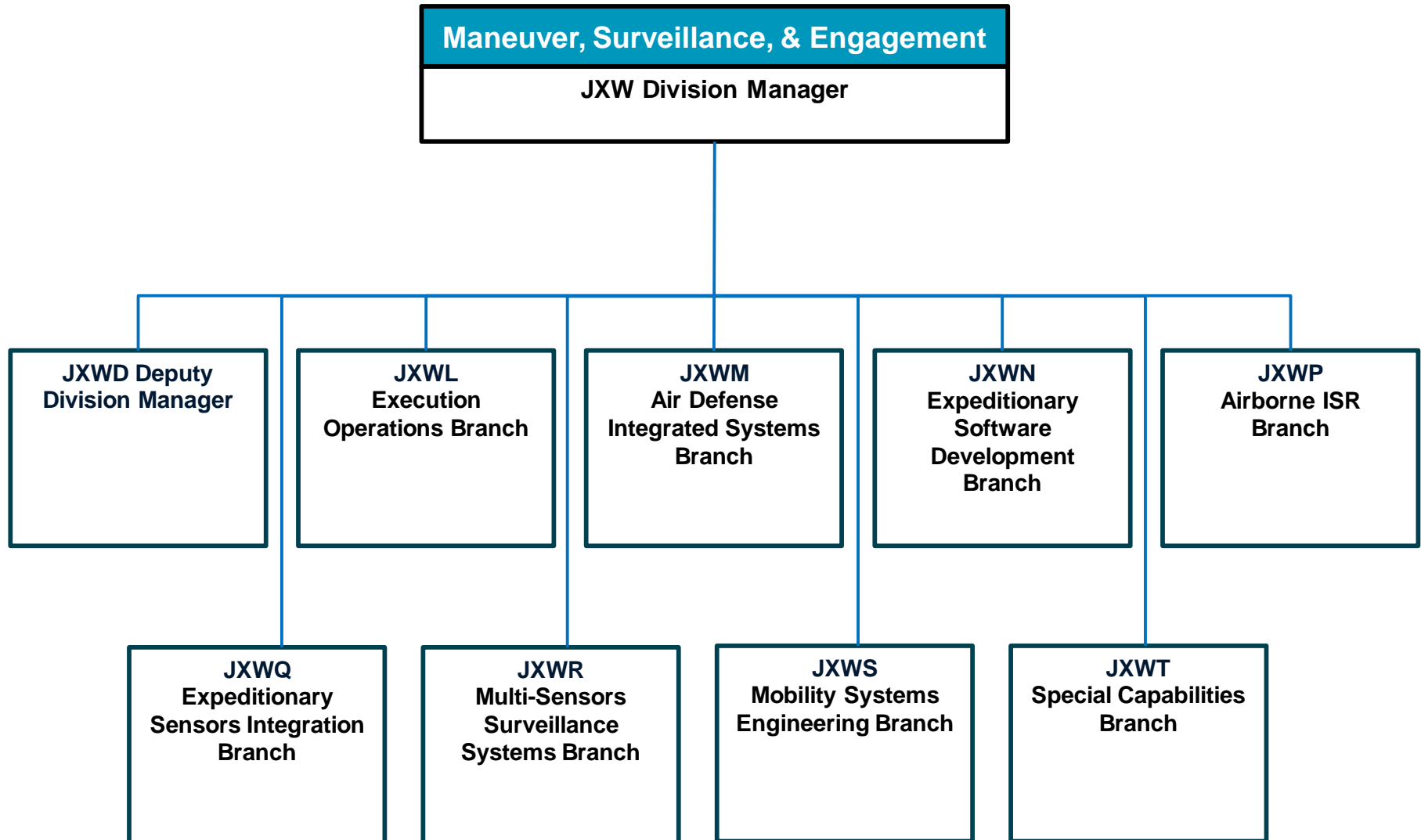

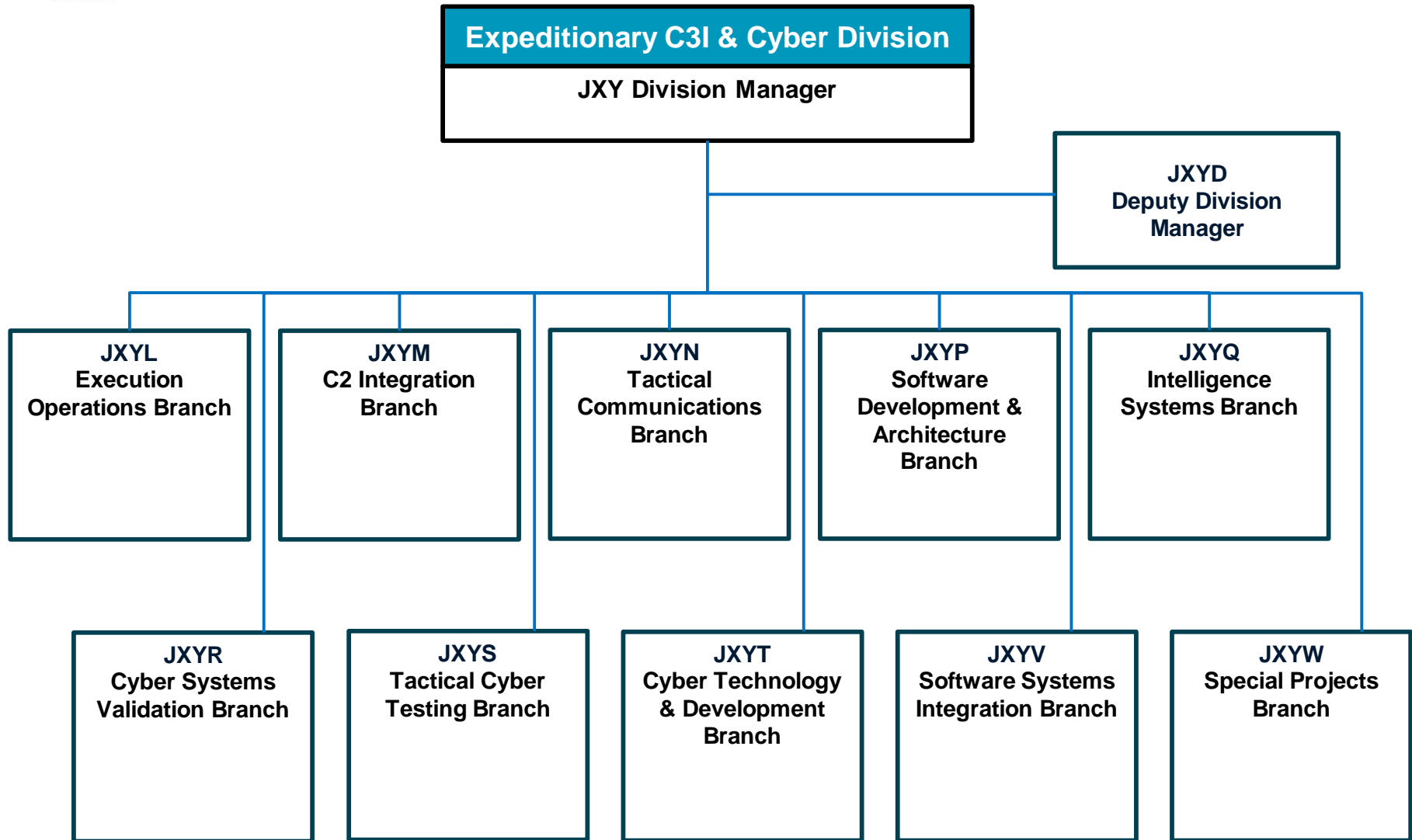

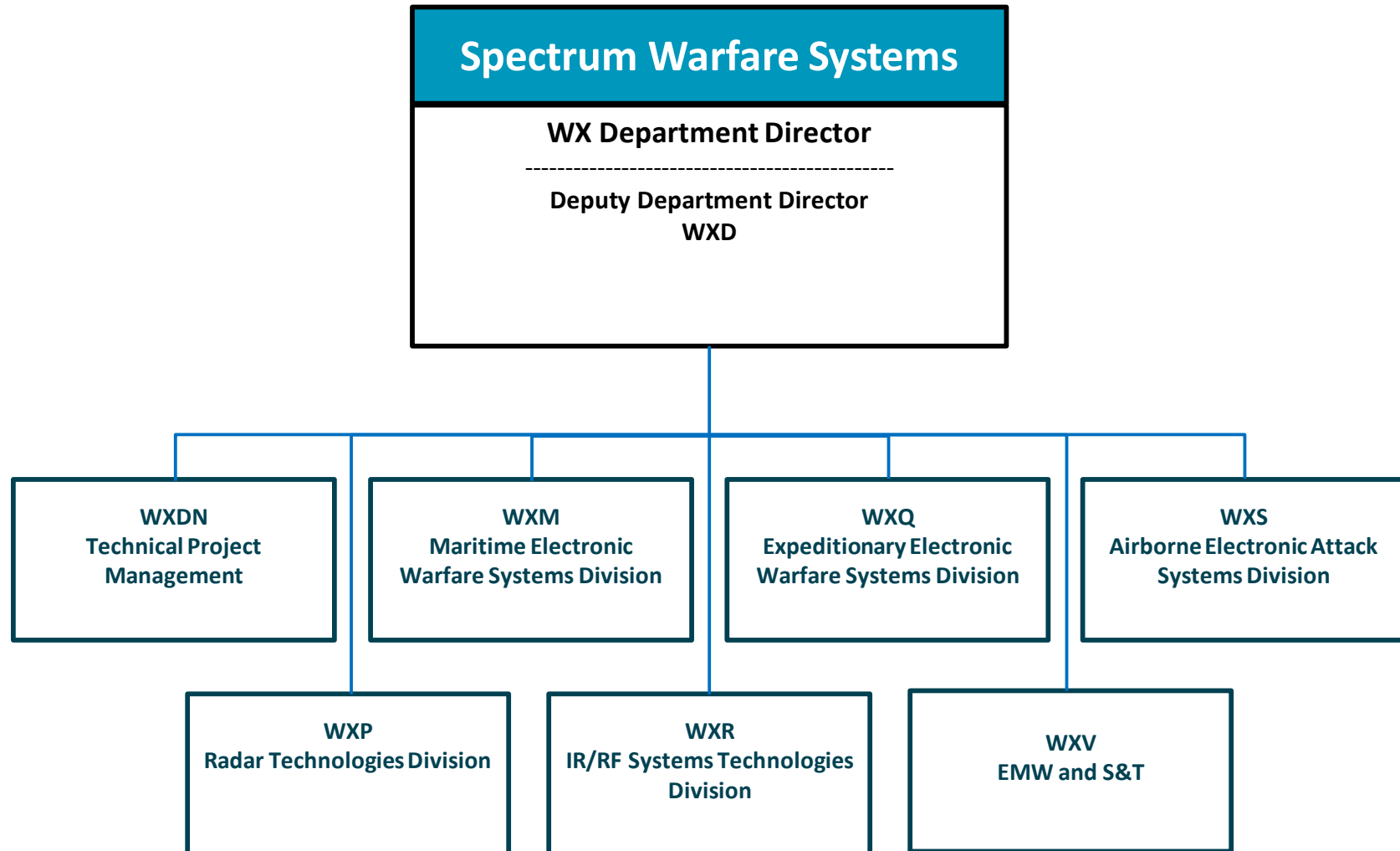

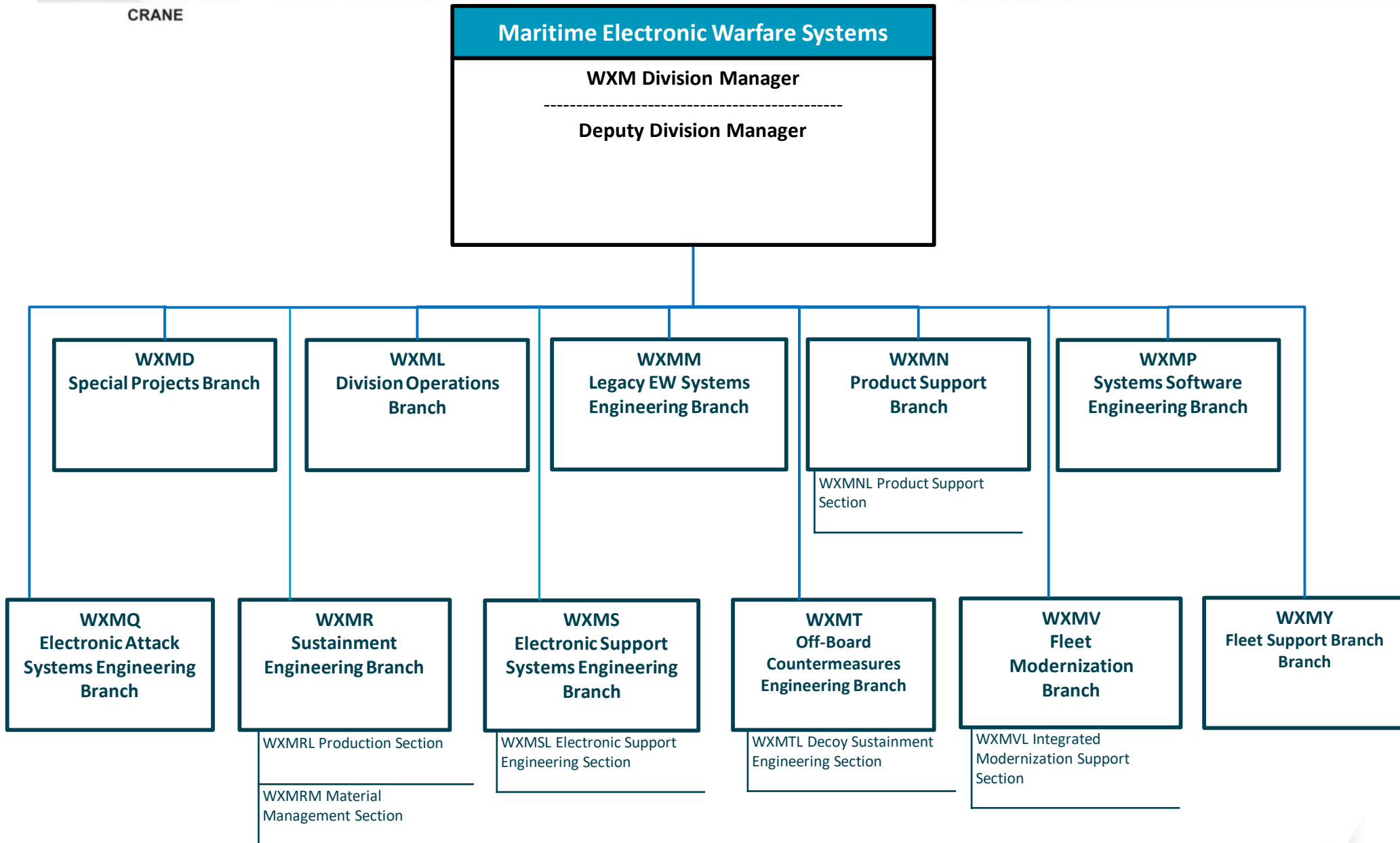

Statement D: Distribution authorized to DoD and DoD Contractors only

