



NAVSEA

WARFARE CENTERS

Indian Head EOD Technology Division

NAVAL SURFACE WARFARE CENTER

INDIAN HEAD EXPLOSIVE ORDNANCE DISPOSAL TECHNOLOGY DIVISION

USAF F-15/F-16/ACES II

26-27 June 2018



Overview



- CAD/PAD Health
- Advanced Concept Ejection Seat (ACES) II Ejection Seat Components
 - JAU-8 Ejection Initiator
 - Harness Release Cartridge
 - Drogue Gun Cartridge
 - CKU-5 Rocket Catapult
 - Trajectory Divergence Rocket Motor (TDRM)
 - Reefing Line & Locking Cord Cutters
 - Digital Recovery Sequencer (DRS) Time Compliance Technical Order (TCTO)
 - Modern ACES Seat Sequencer (MASS) TCTO
- F-15 Components
 - Canopy Remover Cartridge

Overview



- F-16 Components
 - Canopy Jettison Rocket Motor (CJRM)
 - Emergency Canopy Release Line (ECRL)
 - M99 Initiator
 - 0.33/0.40/1.0 Dual Delay Initiator
 - Gas-Actuated DTA Initiator
 - Manually-Actuated Detonation Transfer Assembly (DTA) Initiator
 - Thin Layer Explosive (TLX) lines (DTA Lines)
- F-4 Components
 - Delay Cartridge Assembly
 - Reduced Charge Cartridge Set
 - Thermal Battery
- New Qualified Components
- Shelf/Service Life Changes

CAD/PAD Health



Platform	STATUS						ISSUES
F-15 (one medium risk Hazard Risk Assessment (HRA) - Canopy Remover Cartridges)	Yellow	Green	Green	Green	Green	Green	Internal Canopy Jettison Initiators, Canopy Remover Cartridges, Ejection Sequence Selectors, and Shielded Mild Detonating Cord (SMDC) to Gas Initiators are the only F-15 specific components on a temporary life extension for lack of parts. Late contract awards, manufacturer production problems, Lot Acceptance Test (LAT) failures, capacity, delinquent contract deliveries, 5808.32 propellant/Diminishing Manufacturing Sources and Material Shortages (DMSMS)
F-16 (one medium risk HRA - TLX Lines)	Yellow	Green	Green	Green	Green	Green	TLX Lines, M99 Initiators, and Dual Delay Initiators are the majority of F-16 specific components on a temporary life extension for lack of parts. Late contract awards, manufacturer production problems, LAT failures, product recalls, capacity, and delinquent contract deliveries
ACES II (two medium risk HRAs - DRS, Harness Release Cartridges)	Yellow	Green	Green	Green	Green	Green	Reefing Line Cutters, Trajectory Divergence Rocket Motors, Harness Release Cartridges, and DRS are majority of components on a temporary life extension for lack of parts affecting F-15 and F-16 aircraft. Late contract awards, manufacturer production problems, LAT failures and delinquent contract deliveries
	FY18	FY19	FY20	FY21	FY22	FY23	

ACES II JAU-8 Ejection Initiator



- **Issue:**
 - Production delays on three (3) contracts; components late to need
- **Cause:**
 - Administrative lead times and processes delayed contract award and replacement component deliveries by 13 months
 - Late acquisition/delivery of hardware from sub-tier suppliers
- **Impact:**
 - Temporary life extensions supportable up to 24 months beyond original expiration to accommodate delivery and installation of replacement components
- **Get Well:**
 - FY14; 1,212ea
 - Original delivery due November 2016; now October 2018
 - ✓ Lot 1; 538ea – Shipped March 2018
 - Lot 2; 654ea – Hardware due June 2018
 - FY15 Contract; 415ea
 - Original delivery due June 2017; now May 2019
 - FY16 Contract; 887ea
 - Original delivery due March 2019; now September 2019
 - FY17 PR; 858ea – Estimate contract award by Jul 2018
 - FY18 PR; 571ea – Estimate contract award by Sep 2018

ACES II Harness Release Cartridge



- **Issue:**
 - Successful First Article Test (FAT) Mar 2016; Lot Acceptance Test (LAT) failure Apr 2017
- **Cause:**
 - Manufacturer relocated production facility (2015) – Required First Article Test (FAT) for qualification
 - Alternate supplier output charge cups meet drawing; performance characteristics differ (swelling)
- **Impact:**
 - Four (4) delinquent contracts need to be rebuilt; 2,569ea
 - Temporary life extensions supportable up to 12 months beyond original expiration to accommodate delivery and installation of replacement components
 - Fighter Bomber Program Office Hazard Risk Assessment (Medium Risk), dated Aug 2014
- **Get Well:**
 - FY11 Contract; 339ea (Remaining) - Original delivery due May 2012; now Jul 2018
 - FY14 Contract; 1,372ea - Original delivery due Jun 2016
 - Lot 1; 629ea – To delivery by Oct 2018
 - Lot 2; 743ea – To delivery by Feb 2019
 - FY15 Contract; 502ea – Original delivery due Sep 2016; now Jul 2018
 - FY16 Contract; 356ea – Original delivery due Jun 2018; now Apr 2019
 - FY17 Contract; 208ea – Delivery due Feb 2019 (Alternate Manufacturer)
 - FY18 PR; 280ea – Estimate contract award by Sep 2018

ACES II Drogue Gun Cartridge



- **Issue:**
 - Production delays on one (1) contract; components late to need
- **Cause:**
 - Administrative lead times and processes affecting FY15 procurement package and Military Inter-agency Purchase Requests (MIPR) delayed contract award by 13 months
 - Manufacturer relocated production facility (2015) – Required FAT for qualification
 - Late acquisition/delivery of hardware from sub-tier suppliers
- **Impact:**
 - Temporary life extensions supportable up to 24 months beyond original expiration to accommodate delivery and installation of replacement components
- **Get-well plan:**
 - Successful FAT Nov 2017
 - FY15 Contract; 1,764ea
 - Lot 1; 1,370 – Original delivery due Jul 2017; now Sep 2018
 - Lot 2; 393ea - Original delivery due Nov 2017; now Dec 2018
 - FY17 Contract; 943ea – Delivery due by Mar 2019
 - FY18 PR; 214ea – Estimate contract award by Sep 2018

ACES II CKU-5 Catapult



- **Issue:**
 - Production delays on two (2) contracts; components late to need
- **Cause:**
 - Administrative lead times/processes affecting FY14/FY15 procurement packages and MIPRs delayed contract awards by 13 months and 12 months respectively
 - Lot Acceptance Test (LAT) failures; de-certification of digital x-ray equipment (damaged detector), need for submission/approval of many minor waiver requests; and Ammunition Data card (ADC) approval process delays
- **Impact:**
 - Temporary life extensions supportable up to 24 months beyond original expiration to accommodate delivery and installation of replacement components
- **Get Well:**
 - FY14/FY15 Contract; 892ea
 - ✓ Lot 1; (196ea) - Original delivery due Jan 2017; Shipped May 2018
 - Lot 2; (196ea) – Original delivery due Apr 2017; now Jun 2018
 - Lot 3; (196ea) – Original delivery due Jun 2017; now Jun 2018
 - Lot 4; (198ea) – Original delivery due Aug 2017; now Dec 2018
 - Lot 5; (84ea) – Original delivery due Oct 2017; now Mar 2019
 - Lot 6; (22ea) - Original delivery due Oct 2017; now Jun 2019
 - ❖ FY16/FY17 Contract; 517ea
 - Lot 1; 286ea – Original delivery due by Jun 2018; now Jun 2019
 - Lot 2; 231ea – Original delivery due by Aug 2018; now Dec 2019
 - ❖ FY18 PR; 633ea - Estimate contract award by Jun 2018

ACES II Trajectory Divergence Rocket Motor



- **Issue:**
 - No contract in-place to deliver replacement components since 2012
- **Cause:**
 - Original contracted manufacturer's stockpiled Butarez propellant binder/fuel material became unsuitable after initial contract award (2013)
 - Follow-on contract award delayed 48+ months due to administrative processes and errors with purchase requests (joint buy through US Navy)
 - Five (5) years worth of requirements (FY13-FY17)
- **Impact:**
 - Temporary life extensions supportable up to 24months beyond original expiration to accommodate delivery and installation of replacement components
- **Get Well:**
 - FY13/FY14/FY15/FY16/FY17 Contract; 1,019ea
 - Lot 1; (355ea) - Delivery due by Aug 2018
 - Lot 2; (205ea) - Delivery due by Sep 2018
 - Lot 3; (92ea) – Delivery due by Oct 2018
 - Lot 4; (261ea) – Delivery due by Nov 2018
 - Lot 5; (106ea) – Delivery due by Jan 2019
 - FY18 PR; 45ea – Estimate contract award by Sep 2018

ACES II Parachute Reefing Line Cutter & Survival Kit Locking Cord Cutter



- **Issue:**
 - Multiple delinquent contracts; Sole Source manufacturer unresponsive
- **Cause:**
 - Non-availability of M42 Primers; explosive mishap and investigation; production capacity limitations; competing commercial contract priorities; production backlog
- **Impact:**
 - Temporary life extensions supportable up to 24 months beyond original expiration to accommodate delivery of replacement components and installation
- **Get Well:**
 - **1.15 Second Reefing Line Cutters:**
 - FY14 Contract; 898ea
 - Original scheduled delivery Sep 2014; now Jun 2018
 - FY15 Contract; 185ea
 - Original scheduled delivery Mar 2016; now Jun 2018
 - FY16 Contract; 533ea
 - Original scheduled delivery Jan 2017; now Jul 2018
 - FY17 Contract; 584ea
 - Original scheduled delivery Aug 2017; now Aug 2018
 - FY18 PR; 1,158ea - Estimate contract award by Jun 2018

ACES II Parachute Reefing Line Cutter & Survival Kit Locking Cord Cutter



— 4.0 Second Locking Cord Cutters:

- FY15 Contract; 506ea
 - Original scheduled delivery Oct 2015; now Jul 2018
- FY16 Contract; 403ea
 - Original scheduled delivery Sep 2016; now Aug 2018
- FY17 Contract; 371ea
 - Original scheduled delivery Mar 2017; now Sep 2018
- FY18 PR; 454ea – Estimate contract award by Jun 2018

— Qualify second source manufacturer by Apr 2019

- Solicitation released Oct 2017
- Source Selection – Estimate contract award Jun 2018
 - Delivery due ~Apr 2020
 - Reefing Line Cutter; 1,677ea
 - Locking Cord Cutter; 1,090ea

ACES II Digital Recovery Sequencer (DRS) Shorting Plug TCTO



- **Issue:**
 - Pilot ejected and DRS failed to perform automatic operations (2014)
 - Pilot pulled emergency manual parachute deployment handle for seat-man separation and parachute deployment
- **Cause:**
 - Channel 1 circuit failed due to defective Power-On Reset (POR) chip
 - Channel 3 circuit failed due to firmware bug and noise
- **Impact:**
 - All DRS units affected by firmware and hardware issues that directly contributed to this failure
~8,000 aircraft
 - DRS system reliability requirement is 0.999, 90% confidence; currently 0.056% observed failure rate
 - Fighter Bomber Program Office Hazard Risk Assessment (Medium Risk), dated 19 Dec 2014
- **Get Well:**
 - ✓ Production records reviewed and three DRS units recalled with bad POR chips – Feb 2015
 - ✓ Test port shorting plug qualified to mitigate failures – Jul 2015
 - ✓ Time Compliance Technical Order (TCTO) published January 2016
 - Requires TCTO compliance at 36-month seat inspection by Jan 2020
 - ✓ TCTO Kit provided at no cost for DRS procured via FMS Cases with US Government
 - Shipments began 12 January 2016 and completed 7 September 2016
 - DRS procured with seat/aircraft delivery – Submit Supplier Discrepancy Report against contract
 - DRS to be replaced by the Modernized ACES Seat Sequencer (MASS) through attrition at DRS service life expiration

ACES II Digital Recovery Sequencer (DRS) Shorting Plug TCTO

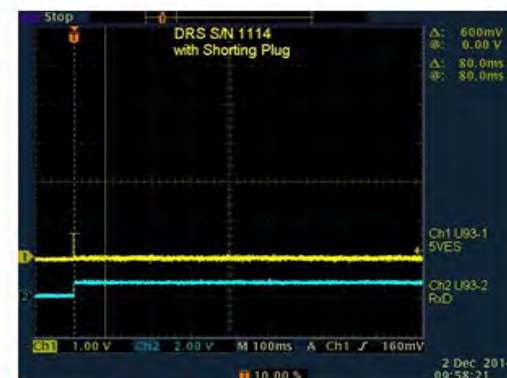
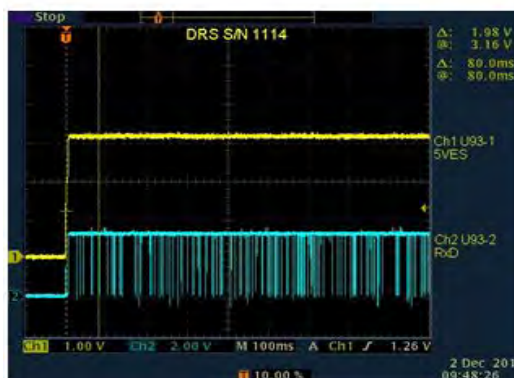
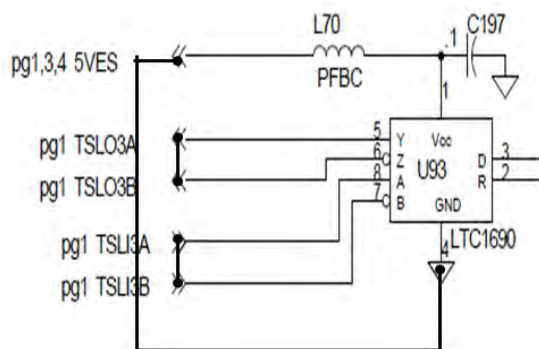
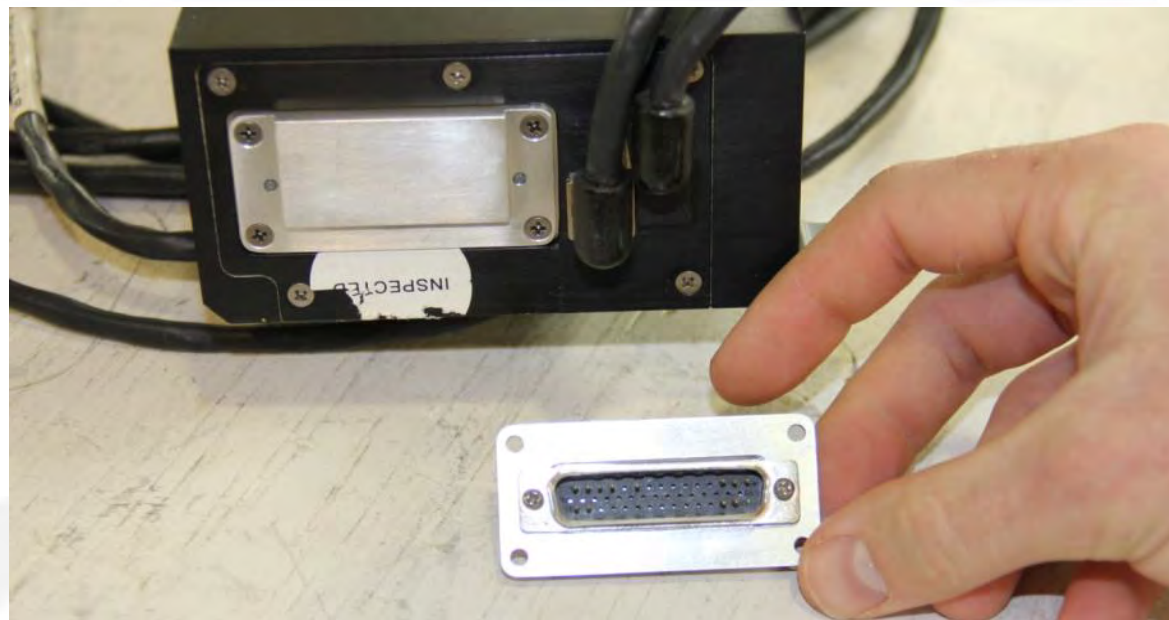

Without shorting plug

With shorting plug

ACES II Modernized ACES Seat Sequencer (MASS) TCTO



- **Issue:**

- MASS replaces the DRS by attrition via TCTO at DRS service life expiration
- Production delays on one (1) contract; components late to need

- **Cause:**

- HQ ACC identified requirement to replace environmental sensor on ACES II Ejection Seat (12 July 2009) - Environmental sensor and TTU-415/E tester are inconsistent
- USAF Safety Center recommendation from 2012 mishap to “replace environmental sensor and current recovery sequencer with a more reliable component to optimize the probability of correct ejection mode selection.”
- Electronics Obsolescence
- Administrative/Legal delays concerning Government Use data rights with FY16 procurement delayed contract award/delivery by 12 months
- Late acquisition of the Pressure Transmission System (PTS) from sub-tier suppliers

- **Impact:**

- Environmental Sensor replaced with Pressure Transmission System (PTS)
- Improved ejection mode determination
- Eliminates need for field-level TTU-415/E Test Set
- Temporary life extensions of DRS supportable up to 15 months beyond original expiration to accommodate delivery and installation

ACES II Modernized ACES Seat Sequencer (MASS) TCTO



Pressure Transmission System (PTS)

**PTS replaces the current
Environmental Sensor**

Pressure Transmission System (PTS)



PTS and
MASS
installed
in ACES II
seat



Analog Sensor



Pressure Transmission System

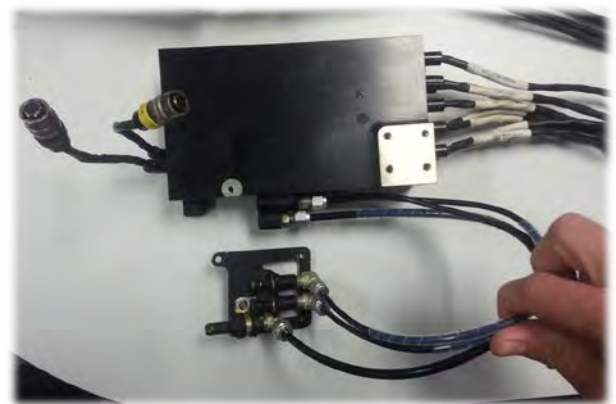

ACES II Modernized ACES Seat Sequencer (MASS) TCTO



- **Get-well plan:**

- ✓ Qualification completed March 2015
- ✓ Airworthiness certification complete - F-16 (Jan 2017); F-15 (Jun 2017)
- ✓ 13A5-56-11 Technical Order and TCTO procedures released Jun 2017
- ✓ FY14 Contract; 220ea – Shipped in-place Apr 2016
- ✓ FY15 Contract; 283ea – Shipped in-place Aug 2016
- ✓ FY16 Contract (4-piece Kit); 106ea – Shipped in-place Nov 2017
- FY16 Contract (2-piece Kit); 1,150ea – Delivery due Sep 2018 through Mar 2019
- FY17 PR; 469ea - Anticipate contract award by Jul 2018
 - Requested delivery is by 29 Mar 2019
- Award 5-Year IDIQ contract by 30 Sep 2018
 - FY18 PR; 340ea – Delivery Order 1
 - FY19 PR; 331ea – Delivery Order 2; award by 31 Jan 2019

F-15 Canopy Remover Cartridge



- **Issue:**

- No contract in-place to deliver replacement components since 2010

- **Cause:**

- HES 5808.32 propellant experienced repeated production failures by industry
- Obsolescence of key ingredient – MPEG plasticizer
- USG challenged for several years to produce useable quantities of propellant
- Defense Contracting Audit Agency (DCAA) investigation into corporate rates took 6 months to complete
 - Stopped all contract awards to sole source manufacturer Oct 2015 – Mar 2016
- Contract Required Delivery Date (Original): Sep 2012
 - ✓ Contract awarded 10 Jun 2016 (4 years of requirements)
 - Contract award delayed due to non-availability of propellant
 - Lot Acceptance Test (LAT) failures in early stages of production

- **Impact:**

- Warfighters flying at risk on temporary life extensions supportable up to 48 months beyond original expiration date to accommodate delivery and installation of replacement components
 - F-15 System Program Office (SPO) Operational Risk Assessment (Medium Risk), dated 16 July 2016
- 69 single seat; 67 dual seat aircraft are on temporary life extensions

F-15 Canopy Remover Cartridge



- **Get Well:**

- ✓ Four (4) successful 5808.32 propellant mixes produced – Mar 2016
- ✓ FY11/FY12/FY13/FY14 Contract awarded – Jun 2016
 - ✓ Lot 2; 26ea (2-Seat) – Shipped in-place Jul 2017
 - ✓ Lot 3; 27ea (2-Seat) – Shipped in-place Feb 2018
 - ✓ Lot 4; 50ea (2-Seat) – Shipped in-place Mar 2018
 - ✓ Lot 5 & 6 (1-Seat); 87ea – Shipped in-place by May 2018
 - Lot 7 (2-Seat); 25ea – Delivery due by Sep 2018
- ✓ FY15/FY16/FY17 Contract awarded – Apr 2018
 - Lot 1; 40ea (2-Seat) – Delivery due Oct 2018
 - Lot 2; 70ea (2-Seta) – Delivery due Feb 2019
 - Lot 3; 75ea (2-Seat) – Delivery due Jul 2019
 - Lot 4; 43ea (1-Seta) – Delivery due Oct 2019
- FY18/FY19 PR; 107ea (2-Seat) – Estimate contract award by Sep 2018
- Complete mechanistic aging assessment and Aging & Surveillance Tests – Sep 2018
 - Evaluate results for potential permanent service life increase

F-15 Canopy Remover Cartridge



FMS F-15 Dual & Single Seat Canopy Remover Cartridge

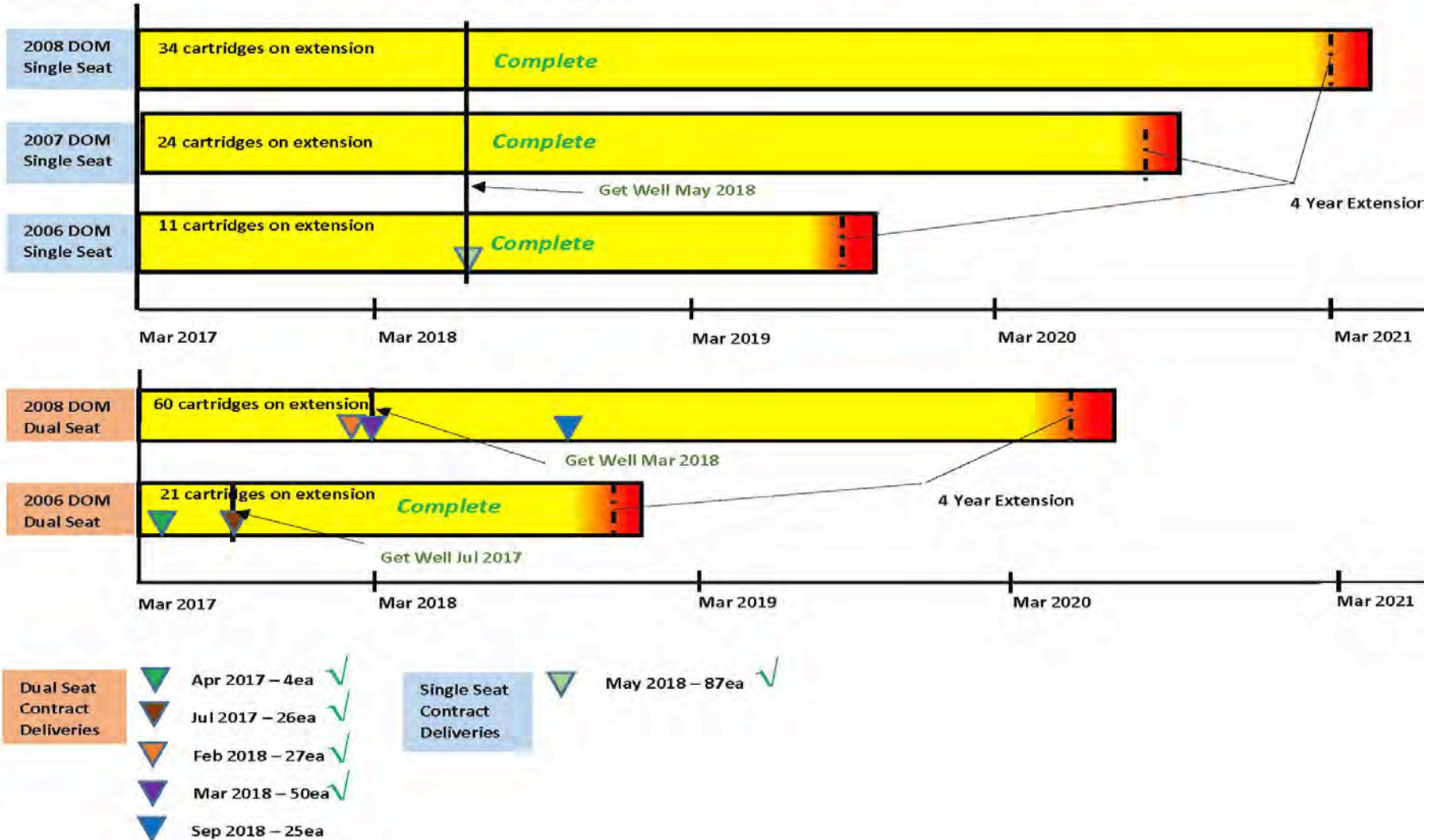

F-16 Canopy Jettison Rocket Motor



- **Issue:**

- Three ruptured motor failures since 2010 at Manufacturer
 - Lot Acceptance Test (LAT) failure 9 Aug 2010
 - Cold unit (-65°F) experienced rapid overpressure (exploded)
 - Batch check unit failure 9 Mar 2012
 - Hot unit (+200°F) experienced rapid overpressure (exploded)
 - LAT failure 28 Oct 2013
 - Hot unit (+200°F) experienced rapid overpressure (exploded)



160 of 290 grams recovered →



Resolved with production now underway

F-16 Canopy Jettison Rocket Motor



- **Cause:**

- Manufacturer A - Insufficient bond strength between propellant, liner, and motor tube case leading to excessive surface area burning and unit overpressure
- Manufacturer B - Propellant grains (PN 55012) cast from TAL-1526 B161 propellant exhibited soft propellant at the machined ends of the grain
 - Exhibited inadequate material strength and was deformable with light hand pressure

- **Impact:**

- Temporary life extensions supportable up to 24 months (NTI and TAC lots) and 48 months (UPC lots) beyond original expiration to accommodate delivery and installation of replacement components
- Manufacturer A product recalled; to be replaced by warranty

- **Get Well:**

- ✓ FY09 Contract; 172ea L/H and 134ea R/H (Warranty Returns)
 - ✓ 134ea R/H delivery complete – Sep 2017
 - ✓ 172ea L/H delivery complete – Mar 2018
- ✓ FY15 Contract; 155ea L/H and 154ea R/H
 - ✓ Original scheduled delivery Dec 2016; Shipped complete Dec 2017
- ✓ FY16 Contract; 88ea L/H and 70ea R/H
 - ✓ Original scheduled delivery May 2017; Shipped complete Dec 2017
- FY17 Contract; 158ea L/H and 253ea R/H – Delivery due by Sep 2018
- FY18 PR; 136ea L/H and 199ea R/H – Anticipate contract award by Sep 2018

F-16 Emergency Canopy Release Line



- **Issue:**
 - 255ea (P/N: 828282-008) delivered to partner countries do not fit in single seat aircraft
- **Cause:**
 - First Article Test (FAT) successful
 - Fit checks conducted three times before “successful” fit approved
 - Production lines did not match dimensions of fit check lines - tooling changed by manufacturer
- **Impact:**
 - Lot Numbers MSV13L001-001 and MSV14F002-001 suspended from issue/use
 - Users directed to submit Supply Discrepancy Report (SDR)
 - User to dispose locally
 - To be replaced by warranty
 - Temporary life extensions supportable up to 36 months beyond original expiration to accommodate delivery and installation of replacement components
- **Get Well:**
 - ✓ Three reworked ECRLs provided to USG for fit check Jul 2015 - One of three acceptable
 - ✓ Non-compliant ECRLs re-bent for fit check Sep 2015 - Still not acceptable
 - ✓ Produce new fit check golden units to meet specification - 31 May 2017
 - ✓ Manufacturer to upgrade tooling and bend fixture to prove repeatable process – Jun 2017
 - ✓ Conduct fit check of new lines – Aug 2017
 - Manufacture to rebuild and replace, via warranty, by September 2018

F-16 M99 Initiator



- **Issue:**
 - Contract delivery of replacement components late to need
- **Cause:**
 - Production delayed due to foreign material outside of primers during x-ray inspection
 - Primer is internal component to M91 Impulse Cartridge installed into the M99 Initiator
 - Loose primer composition is classified as critical defect (unknown aging characteristics)
 - Late acquisition/delivery of hardware from sub-tier suppliers
- **Impact:**
 - Temporary life extensions supportable up to 24 months beyond original expiration to accommodate delivery and installation of replacement components
- **Get Well:**
 - ✓ FY13 Contract; 160ea – original delivery due Dec 2016; shipped Apr/May 2018
 - FY14 Contract; 264ea - original delivery due Mar 2018; now Mar 2019
 - FY15 Contract; 64ea – original delivery due Sep 2017; now Mar 2019
 - FY16 Contract; 174ea - original GFM delivery Mar 2018; now Dec 2018
 - Contract to be awarded upon completion of GFM production delivery
 - FY17 Contract; 91ea – GFM delivery due Dec 2018
 - Contract to be awarded upon completion of GFM production delivery
 - FY18 PR; 67ea – GFM work order issued May 2018
 - Contract to be awarded upon completion of GFM production delivery

F-16 0.33 Dual Delay Initiator



- **Issue:**
 - Production delays on one (1) contract; components late to need
- **Cause:**
 - Administrative delays within contracting to award FY15 procurement package delayed contract award by 15 months
 - High order quantity has driven significant delays in receiving hardware from sub-tier suppliers to meet contractual delivery date
- **Impact:**
 - Temporary life extensions supportable up to 24 months beyond original expiration to accommodate delivery and installation of replacement components
- **Get Well:**
 - FY15 Contract; 1,000ea – original delivery due Dec 2017
 - Lot 1; 350ea – now Jun 2018
 - Lot 2; 650ea – now Jul 2018
 - FY16 Contract; 364ea – delivery due by Jul 2018
 - FY17 Contract; 427ea - delivery due by Feb 2019
 - FY18 Contract; 202ea – delivery due by Oct 2019
 - FY19 PR; 111ea – estimate contract award by May 2019

F-16 0.40 Dual Delay Initiator



- **Issue:**
 - Production delays on one (1) contract; components late to need
- **Cause:**
 - Administrative delays within contracting to award FY15 procurement package delayed contract award by 15 months
 - High order quantity has driven significant delays in receiving hardware from sub-tier suppliers to meet contractual delivery date
- **Impact:**
 - Temporary life extensions supportable up to 24 months beyond original expiration to accommodate delivery and installation of replacement components
- **Get Well:**
 - ✓ FY15 Contract; 121ea – original delivery due Dec 2017
 - ✓ Shipped in-place Mar 2018
 - FY16 Contract; 120ea – delivery due by Jul 2018
 - FY17 Contract; 181ea - delivery due by Feb 2019
 - FY18 Contract; 91ea – delivery due by Oct 2019
 - FY19 PR; 296ea – estimate contract award by May 2019

F-16 1.0 Dual Delay Initiator



- **Issue:**
 - Production delays on one (1) contract; components late to need
- **Cause:**
 - Administrative delays within contracting to award FY15 procurement package delayed contract award by 15 months
 - High order quantity has driven significant delays in receiving hardware from sub-tier suppliers to meet contractual delivery date
- **Impact:**
 - Temporary life extensions supportable up to 24 months beyond original expiration to accommodate delivery and installation of replacement components
- **Get Well:**
 - ✓ FY15 Contract; 100ea – original delivery due Dec 2017
 - ✓ Shipped in-place Mar 2018
 - FY16 Contract; 249ea – delivery due by Jul 2018
 - FY17 Contract; 129ea - delivery due by Feb 2019
 - FY18 Contract; 232ea – delivery due by Oct 2019
 - FY19 PR; 61ea – estimate contract award by May 2019

F-16 Gas-Actuated DTA Initiator



- **Issue:**
 - Contract delivery of replacement components late to need
- **Cause:**
 - Administrative delays within contracting to award FY15 procurement package delayed contract award by 15 months
- **Impact:**
 - Temporary life extensions supportable up to 24 months beyond original expiration to accommodate delivery and installation of replacement components
- **Get Well:**
 - ✓ FY15 Contract; 924ea – delivery due Dec 2017
 - ✓ Shipped in-place Sep 2017
 - FY16 Contract; 1,172ea – delivery due by Jul 2018
 - FY17 Contract; 823ea - delivery due by Feb 2019
 - FY18 Contract; 326ea – delivery due by Oct 2019
 - FY19 PR; 1,346ea – estimate contract award by May 2019

F-16 Manually-Actuated DTA Initiator



- **Issue:**
 - Contract delivery of replacement components late to need
- **Cause:**
 - Administrative delays within contracting to award FY15 procurement package delayed contract award by 15 months
- **Impact:**
 - Temporary life extensions supportable up to 24 months beyond original expiration to accommodate delivery and installation of replacement components
- **Get Well:**
 - ✓ FY15 Contract; 334ea – delivery due Dec 2017
 - ✓ Shipped in-place Oct 2017
 - FY16 Contract; 807ea – delivery due by Jul 2018
 - FY17 Contract; 2,139ea - delivery due by Feb 2019
 - FY18 Contract; 682ea – delivery due by Oct 2019
 - FY19 PR; 763ea – estimate contract award by May 2019

F-16 Thin Layer Explosive (TLX) Lines



- **Issue:**

- Obsolescence of Halar 300 (Plastic beads used in TLX thin layer explosive cord)
 - Sole source TLX manufacturer notified by sub-tier supplier they no longer produce small runs of Halar 300
 - March 2012, TLX manufacturer submitted Engineering Change Proposal (ECP) indicating Halar 300 was obsolete & replacement material was Halar 300LC (Low Corrosive)
 - US Government required Halar 300LC meet all F-16 specifications for TLX performance and shelf/service life
 - TLX Manufacturer did not provide adequate testing to prove the material would age to meet the assigned shelf/service life of TLX lines
 - US Government rejected ECP
 - CAD/PAD Joint Program Office asked Halar 300 supplier to determine if a last procurement was possible
 - Contract awarded for production run of 26,400 pounds; shipped 2013
 - New contract negotiated with TLX manufacturer to extrude Halar 300 plastic into explosive cord with stainless steel over-braid
 - Stocked at TLX manufacturer and provided as government furnished material (GFM) to be manufactured into TLX lines – 2014
 - Production resumed with increased operators and production shifts to meet backlog

F-16 Thin Layer Explosive (TLX) Lines



— Product Recall/Suspension #1 – February 2015

- Three production shifts implemented to fill backlog once GFM braided cord was available (~1,000 lines/month)
- Production engineer identified new operator did not cut sufficient material from rejected sections & splices
 - Automated inspection equipment sprays red mark on areas with high or low explosive core load; 80" sections to be removed
 - Affected lines produced/delivered in 2014 are restricted from issue and currently pending warranty replacements
 - User to dispose locally

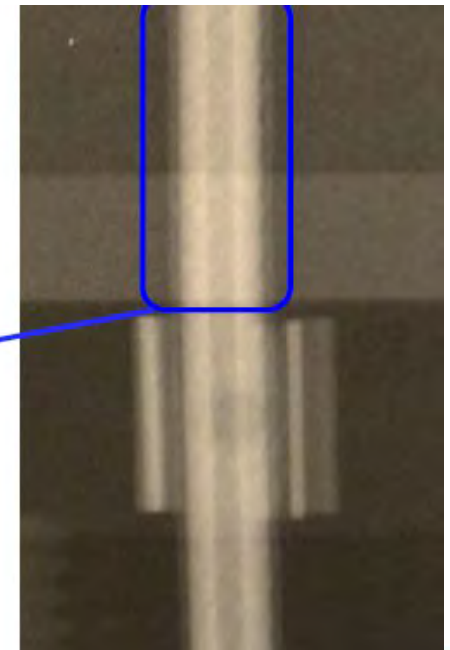
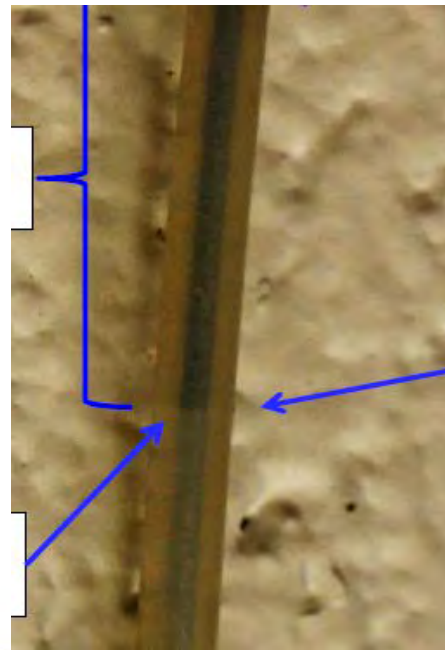

F-16 Thin Layer Explosive (TLX) Lines



- Lot Acceptance Test (LAT) Failure – December 2014
 - During routine LAT a single line failed to propagate
 - Initial investigation looked at many possible factors but pointed to test fixture causing line kinking
 - Fixture modified with new “Z” bend fitting and double sampling added; additional failures occurred
 - Extensive explosive core load measurements revealed some lines were very low & some high
- Product Recall/Suspension #2 – June 2016
 - Investigation identified all 2014 and 2015 produced TLX lines as suspect and recall issued
 - Suspension from issue released for affected lines
 - Low/high core loads due to improper laser core load sensing system calibration (**Root Cause**)



TLX Line with propagation stoppage, SN 2186



TLX line with full propagation, SN 2184

F-16 Thin Layer Explosive (TLX) Lines



- **Impact:**

- Temporary life extensions supportable up to 72 months beyond original expiration to accommodate delivery and installation of replacement components
 - F-16 System Program Office Hazard Risk Assessment (Medium Risk), dated 27 June 2016
- Multiple delinquent Contracts/Delivery Orders (DO)
 - FY12 Contract = 2,342ea
 - FY13 Contract; DO 1 = 1,448ea
 - FY14 Contract; DO 2 = 1,792ea

- **Closure Plan:**

	<u>Baseline</u>	<u>Current</u>
✓ Core load failure investigation/improved inspection & process procedures	Oct 2016	
✓ Trial process runs to validate updated procedures	Nov 2016	
✓ First Article Test (FAT) – Several lines vented/one severed	Mar 2017	
✓ Coordinate w/ B-2, F-16, B-1 SPO for concurrence/risk acceptability	Mar 2017	
✓ Return to production at initial rate of ~1,000/month	Mar 2017	
• ~18,000+ TLX lines on backlog (USAF/FMS, Navy, Commercial)		
☐ FY12 Contract	Mar 2013	
✓ Deliver -721 & -723 lines		Mar 2018
☐ Deliver remaining P/N lines		Jul 2018
☐ FY13 Contract (DO 1) Delivery	Apr 2014	Nov 2018
☐ FY14 Contract (DO 2) Delivery	Nov 2016	Nov 2018
✓ Award 5-Year IDIQ Contract	Feb 2017	Mar 2018
☐ FY15/FY16/FY17 Contract (DO 1) Delivery; 5,172ea	Sep 2019	
☐ FY18 Contract (DO 2) Award	Jun 2018	
☐ FY19 Contract (DO 3) Award	Jan 2019	

F-4 Delay Cartridge



- **Issue:**

- Production delays on one (1) contract; components late to need

- **Cause:**

- Late acquisition of hardware from sub-tier suppliers
- Ammunition Data Card (ADC) acceptance/approval by DCMA driving delivery delays

- **Impact:**

- Temporary life extensions supportable up to 36 months beyond original expiration to accommodate delivery and installation of replacement components

- **Get Well:**

- ✓ FY16 Contract; 55ea – original delivery due Jul 2017
 - ✓ Shipped in-place at manufacturer Apr 2018
- FY17 Contract; 7ea – delivery due by Oct 2018
- FY18/FY19 – No requirements

F-4 Cartridge Set (Reduced Charge)



- **Issue:**
 - Production delays on one (1) contract; components late to need
- **Cause:**
 - Packaging and SIR submittal
- **Impact:**
 - Temporary life extensions supportable up to 15 months beyond original expiration to accommodate delivery and installation of replacement components
- **Get Well:**
 - Contract N0010417CK004; 74ea – original delivery due Jan 2018; now Jul 2018
 - Lot Release Nov 2017; pending shipment; SIR# 949729

F-4 Thermal Battery



- **Issue:**

- Sole Source Manufacturer has shut down the Thermal Battery production line
 - Will only resume production for procurements with a minimum order of 400ea

- **Cause:**

- Current combined requirements total 96ea

- **Impact:**

- Temporary life extensions are no longer recommended

- **Get Well:**

- Users investigating feasibility of Aging & Surveillance Testing through USG
- USG seeking approval to release drawings and qualification matrix to allow for self-funded second source efforts
- USG pursued existing sole source manufacturer for one final production estimate on existing requirement – Customers are evaluating

New Qualified Components



- Trajectory Divergence Rocket Motor (ACES II)
 - ✓ Obsolete propellant replaced; performance remains unchanged
 - NSN: 1377-01-630-5139; P/N: 30614-13
- Harness Release Cartridge (ACES II)
 - ✓ Changed manufacture location
 - ✓ Technical Data Package remains unchanged
 - NSN: 1377-01-649-5552; P/N: 6284200
- Drogue Gun Cartridge (ACES II)
 - ✓ Changed manufacture location
 - ✓ Technical Data Package remains unchanged
 - NSN: 1377-01-625-2801; P/N: 6284100

New Qualified Components



- Canopy Remover Cartridge (F-15C)
 - ✓ Hazard Classification record updated due to increased Net Explosive Weight (NEW)
 - ✓ Technical Data Package and performance remains unchanged
 - NSN: 1377-01-648-8443ES; P/N: 2297800-1

- .75 Time Delay Initiator (F-15)
 - ✓ Configuration changed from single primer to dual primer
 - ✓ Performance remains unchanged
 - NSN: 1377-01-648-8442ES; P/N: 21301900-2

Shelf/Service Life Changes



- **Harness Release Cartridge (ACES II)**
 - NSN: 1377-01-368-5411ES; P/N: 9392046-2
 - ✓ Shelf/Service Life increased from 96/96 to 120/108
 - NSN: 1377-01-052-8206ES; P/N: 1002-41
 - ✓ Shelf/Service Life increased from 96/96 to 132/120
- **Locking Cord Cutter (ACES II)**
 - NSN: 1377-01-333-9143ES; P/N: CI-4.0
 - ✓ Shelf/Service Life increased from 132/120 to 156/132
- **Gyro Spin-up Gas Generator Cartridge (ACES II)**
 - NSN: 1377-01-319-3847ES; P/N: 6066100-02
 - ✓ Shelf/Service Life increased from 84/84 to 96/84
 - NSN: 1377-01-053-0537ES; P/N: 1004-3
 - ✓ Shelf/Service Life increased from 84/84 to 96/84
- **Power Module (ACES II)**
 - NSN: 1377-01-524-2412ES; P/N: 1847-066-01
 - ✓ Shelf/Service Life increased from 90/90 to 120/96

Shelf/Service Life Changes



- JAU-8/A25 Ejection initiator (ACES II)
 - NSN: 1377-00-403-4827ES; 11731737
 - ✓ Shelf/Service Life increased from 132/132 to 144/132
- Drogue Severance Assy (ACES II)
 - NSN: 1377-01-234-0706ES; P/N: 6012100-04
 - ✓ Shelf/Service Life increased from 108/108 to 120/108
- CKU-5 Catapult (ACES II)
 - NSN: 1377-01-520-9738ES; P/N: 512-174-0068
 - ✓ Shelf/Service Life increased from 96/96 to 108/108
- Gas-Actuated DTA Initiator (F-16)
 - NSN: 1377-01-271-7161ES; P/N: 6073100
 - ✓ Shelf/Service Life increased from 84/84 to 96/84
- M99 Initiator (F-16)
 - NSN: 1377-00-731-9271ES; P/N: 10520405
 - ✓ Shelf/Service Life increased from 236/216 to 252/216

Shelf/Service Life Changes



- Canopy Jettison Rocket Motor (F-16)
 - NSN: 1377-01-057-5431ES; P/N: 2820100-2
 - NSN: 1377-01-058-0122ES; P/N: 2820100-1
 - ✓ Shelf/Service Life increased from 132/120 to 156/132
- Canopy Jettison Rocket Motor (F-16)
 - NSN: 1377-01-327-7872ES; P/N: 1517-002
 - NSN: 1377-01-327-7873ES; P/N: 1517-001
 - ✓ Shelf/Service Life increased from 144/132 to 156/132
- Internal Canopy Jettison Initiator (F-15)
 - NSN: 1377-00-322-0778ES; P/N: 2271700-2
 - ✓ Shelf/Service Life increased from 108/108 to 120/108
 - NSN: 1377-01-166-4266ES; P/N: 6036300
 - ✓ Shelf/Service Life increased from 72/72 to 108/96
- One-Wat Transfer Initiator (F-15)
 - NSN: 1377-01-167-6621ES; P/N: 6036200-01
 - NSN: 1377-01-220-3746ES; P/N: 816890-1
 - ✓ Shelf/Service Life increased from 144/108 to 144/120



QUESTIONS ?